

# 2714

---

SPECTRUM  
ANALYZER

## User Manual

*Please check for CHANGE INFORMATION  
at the rear of this manual.*

---

First Printing JUNE 1992

**Tektronix**<sup>®</sup>  
COMMITTED TO EXCELLENCE

AURAL (FM) DEVIATION Measurement, 6-20  
  Enable AURAL (FM) DEVIATION Measurement, 6-21  
AUTO, 4-11  
  RES BW, 4-11, 5-17  
  SWEEP, 4-11  
Auto Res BW, 5-17  
Automatic Mode, 6-44  
Auxiliary Operations, 6-47  
  Line Modulation, 6-48  
  Listen, 6-49  
  View Modulation (Field), 6-47  
  View Picture, 6-49  
Average Noise, Measuring, 7-47

---

## B

B,C MINUS A. *See Subtracting Stored Signals*  
B,C Minus A Display, 4-33  
B,C Minus A Offset Display, 4-33  
Backspace Key, 4-7  
Bandwidth Mode Selection, 4-29  
Broadcast (AM) Video, 4-30  
Built-in Speaker, 3-11

---

## C

Cal Signal @100 MHz 18.8 dBmV, 4-35  
Calibrator, Built-in, 3-12  
Calibrator, Turning On and Off, 7-5  
Carrier Levels, 4-22  
CARRIER LEVELS Measurement, 6-12  
  Enable CARRIER LEVELS Measurement, 6-12  
Carrier Survey, 4-22

CARRIER SURVEY Measurement, 6-14  
  Enable CARRIER SURVEY Measurement, 6-14  
  FAST SURVEY OFF, 6-15  
  FAST SURVEY ON, 6-15  
CARRIER TO NOISE Measurement, 6-22  
  Enable CARRIER TO NOISE Measurement, 6-23  
Carrier To Noise Measurement, 4-24  
Carrier To Noise Selection, 4-29  
Carrier-to-Noise Ratios, Measuring, 7-48  
CATV Characteristics, 2-1  
CATV Measurement Mode  
  Aural (FM) Deviation, 4-23  
  Carrier Levels, 4-22  
  Carrier Survey, 4-22  
  Carrier To Noise, 4-24  
  Frequency Response, 4-25  
  HUM/LFD, 4-24  
  Modulation Depth, 4-23  
  Recenter Channel, 4-22  
CATV Measurement Results Files, 7-78  
CATV Measurements  
  AURAL (FM) DEVIATION Measurement, 6-20  
  CARRIER LEVELS Measurement, 6-12  
  CARRIER SURVEY Measurement, 6-14  
  CARRIER TO NOISE Measurement, 6-22  
  Cross Modulation, 4-28  
  CROSS MODULATION Measurement, 6-41  
  CTB/CSO, 4-27  
  CTB/CSO Measurement, 6-32  
  FREQUENCY RESPONSE Measurement, 6-27  
  General (CATV) 2714 Mode, 6-4  
  HUM/LFD Measurement, 6-24  
  Initial Setup, 6-3

## **Instrument Serial Numbers**

Each instrument manufactured by Tektronix has a serial number on a panel insert or tag, or stamped on the chassis. The first letter in the serial number designates the country of manufacture. The last five digits of the serial number are assigned sequentially and are unique to each instrument. Those manufactured in the United States have six unique digits. The country of manufacture is identified as follows:

B010000	Tektronix, Inc., Beaverton, Oregon, USA
E200000	Tektronix United Kingdom, Ltd., London
J300000	Sony/Tektronix, Japan
H700000	Tektronix Holland, NV, Heerenveen, The Netherlands

Instruments manufactured for Tektronix by external vendors outside the United States are assigned a two digit alpha code to identify the country of manufacture (e.g., JP for Japan, HK for Hong Kong, IL for Israel, etc.).

Tektronix, Inc., P.O. Box 500, Beaverton, OR 97077

Printed in U.S.A.

Copyright © Tektronix, Inc., 1992. All rights reserved. Tektronix products are covered by U.S. and foreign patents, issued and pending. The following are registered trademarks: TEKTRONIX, TEK, TEKPROBE, and SCOPE-MOBILE.

### **Option 34 (Cradle Type Rackmount Adapter)**

Option 34 consists of a front panel mask and rack mounting cradle which adapts the 2714 to a standard 482.6 mm (19 in.) rack. The adapter requires 177.8 mm (7 in.) vertical rack space.

This option preserves the portability of the 2714. Slide assemblies are provided for front access to, and easy removal of, the 2714.



## WARRANTY

Tektronix warrants that this product will be free from defects in materials and workmanship for a period of one (1) year from the date of shipment. If any such product proves defective during this warranty period, Tektronix, at its option, either will repair the defective product without charge for parts and labor, or will provide a replacement in exchange for the defective product.

In order to obtain service under this warranty, Customer must notify Tektronix of the defect before the expiration of the warranty period and make suitable arrangements for the performance of service. Customer shall be responsible for packaging and shipping the defective product to the service center designated by Tektronix, with shipping charges prepaid. Tektronix shall pay for the return of the product to Customer if the shipment is to a location within the country in which the Tektronix service center is located. Customer shall be responsible for paying all shipping charges, duties, taxes, and any other charges for products returned to any other locations.

This warranty shall not apply to any defect, failure or damage caused by improper use or improper or inadequate maintenance and care. Tektronix shall not be obligated to furnish service under this warranty a) to repair damage resulting from attempts by personnel other than Tektronix representatives to install, repair or service the product; b) to repair damage resulting from improper use or connection to incompatible equipment; or c) to service a product that has been modified or integrated with other products when the effect of such modification or integration increases the time or difficulty of servicing the product.

**THIS WARRANTY IS GIVEN BY TEKTRONIX WITH RESPECT TO THIS PRODUCT IN LIEU OF ANY OTHER WARRANTIES, EXPRESSED OR IMPLIED. TEKTRONIX AND ITS VENDORS DISCLAIM ANY IMPLIED WARRANTIES OF MERCHANTABILITY OR FITNESS FOR A PARTICULAR PURPOSE. TEKTRONIX' RESPONSIBILITY TO REPAIR OR REPLACE DEFECTIVE PRODUCTS IS THE SOLE AND EXCLUSIVE REMEDY PROVIDED TO THE CUSTOMER FOR BREACH OF THIS WARRANTY. TEKTRONIX AND ITS VENDORS WILL NOT BE LIABLE FOR ANY INDIRECT, SPECIAL, INCIDENTAL, OR CONSEQUENTIAL DAMAGES IRRESPECTIVE OF WHETHER TEKTRONIX OR THE VENDOR HAS ADVANCE NOTICE OF THE POSSIBILITY OF SUCH DAMAGES.**

## Appendix D: System Messages

The Inverter also contains a charger and an auxiliary 18 VDC output to power external devices such as Low Noise Block Down Converters (LNB) used in satellite downlink applications.

### **Option 08 (RS-232 Communications Port)**

Option 08 provides an RS-232 serial communications port and a Programmer Manual. This port conforms closely to the IEEE P1174.232 Draft Standard that defines the features and functions of the RS-232 interface as it applies to instrument systems. However, it does not necessarily comply with the three-level protocol presently proposed. The port is activated and configured with the UTIL Menu. The port connector is located on the rear panel of the 2714.

For programming instructions, see your Programmer Manual. Connector terminations may be found in the Programmer Manual or in the External Input and Output section of this manual. To configure the RS-232 port, see System Configuration in Section 7 of this manual.

### **Option 15 (TV Sideband Analyzer Interface)**

Option 15 provides an interface for the Tektronix 1405 TV Sideband Analyzer. The 1<sup>st</sup> LO is buffered, routed to J101 on the 2714 rear panel, and terminated in 50  $\Omega$ . The 2714/1405 combination enables you to measure TV modulator/transmitter frequency responses.

### **Option 30 (Rackmount Adapter)**

Option 30 provides the hardware for installing the 2714 in a standard 426.6 mm (19 in.) rack. The rackmount adapter requires minimum vertical space of 133.35 mm (5.25 in.) (an alternate cradle-mount adapter is also available — see Option 34). The 2714 meets all electrical and environmental specifications when it is mounted according to the procedures accompanying Option 30.

### **Option 33 (Travel Line Package)**

Option 33 provides a Travel Line package including a rain cover, accessory pouch, gray CRT filter, and carrying strap.



---

## Options

This section describes the features of the options for the 2714. All options are factory installed.

### **Option M1 – Option M3 (Extended Service and Warranty Options)**

There are three extended service and warranty options offered for the 2714 that go beyond the basic one-year coverage. Contact your local Tektronix Field Office or representative for details.

- Option M1 — Two routine calibrations to published specifications in years two and three, respectively, of warranty coverage, plus two years remedial service.
- Option M2 — Four years remedial service.
- Option M3 — Four routine calibrations to published specifications in years two, three, four, and five, respectively of product ownership, plus four years of remedial service.

### **Option 03 (GPIB Communications Port)**

Option 03 supplies a GPIB communications port that conforms to the IEEE Standard 488 General Purpose Interface Bus and a Programmer Manual. The port is activated and configured with the UTIL menu. The 24-pin port connector is located on the rear panel of the 2714.

For programming instructions, see your Programmer Manual. Connector terminations may be found in the Programmer Manual or in the External Input and Output section of this manual. To configure the GPIB port, see System Configuration in Section 7 of this manual.

### **Option 07 (Inverter/Battery Pack)**

Option 07 supplies a Tektronix 2704 DC-to-AC Inverter, 2705 Battery Pack, Instruction Manual, and necessary mounting hardware. This option allows operation of the 2714 in locations where AC power is not available. The 2705 provides approximately one hour operation when used with the 2704 Inverter and 2714. Operating time can be extended by using additional 2705 Battery Packs, or alternate 12 VDC sources.



This manual contains operating information for the Tektronix 2714 Spectrum Analyzer and includes menus and operating features.

For manual ordering information, refer to the Replaceable Mechanical Parts List (Accessories List) at the rear of the Service manual or contact your local Tektronix Field Office or representative.

---

## Who Should Use This Manual?

This manual is intended for electronic technicians with experience in making cable television-related measurements.

---

## Standards and Conventions Used

Most terminology is consistent with standards adapted by IEEE and IEC. Abbreviations used in the instrument and in the documentation are consistent with ANSI Y1.1–1972. Copies of the ANSI and IEEE standards can be ordered from the Institute of Electrical and Electronic Engineers Inc.

---

## Change/History Information

Manual corrections or additional information is included when manual pages are revised. A revised page is identified by a revision date located in the lower inside corner of the page.

Contact any Tektronix Service Center for information.

**Table D-2: Optional Power Cords (Cont.)**

<b>Option</b>	<b>Description</b>
A4	North American, 240 V/60 Hz at 12A
A5	Swiss, 220 V/50 Hz at 6A

**Table D-3: Optional Accessories**

<b>Accessory</b>
Coaxial cable, 75 $\Omega$ BNC to BNC, 609.6 mm (24 in.)
Coaxial cable, 75 $\Omega$ BNC to BNC, 1066.8 mm (42 in.)
Coaxial cable, 50 $\Omega$ BNC to BNC, 1066.8 mm (42 in.)
Rain Cover
Accessory Pouch
Viewing Hood
Carrying Strap
Service Kit
CRT Light Filter (clear)
CRT Light Filter (gray)
Service Manual
Transit Case

**Welcome**



# Appendix D: Accessories & Options

---

## Accessories

The 2714 is shipped with the standard accessories listed in Table D-1. Optional AC mains power cords are also available meeting various international standards (see Table D-2). Optional accessories are listed in Table D-3.

**Table D-1: Standard Accessories**

<b>Accessory</b>
User Manual
Programmer Manual
Pocket Reference
Cable TV Test Software Manual
PC Software
U.S. Power Cord
Front Cover
Adapter, 75½ Female F-to-Female BNC
Adapter, 75½ Female-to-Female F

**Table D-2: Optional Power Cords**

<b>Option</b>	<b>Description</b>
A1	Universal Euro, 220 V/50 Hz at 16A
A2	United Kingdom, 240 V/50 Hz at 13A
A3	Australian, 240 V/60 Hz at 10A





# Table of Contents

General Safety Summary .....	xv
Symbols and Terms .....	xv
Specific Precautions .....	xvi
Safety Summary .....	xix

---

## Introduction

Introduction .....	1-1
Manual Organization .....	1-1
General .....	1-1
Specific .....	1-2
General Information .....	1-3
What Is a Spectrum Analyzer? .....	1-3
What Can You Do With A Spectrum Analyzer? .....	1-4
About the 2714 .....	1-4

---

## Specification

Specification .....	2-1
Electrical Characteristics .....	2-1

---

## Getting Acquainted With Your Instrument

Getting Acquainted With Your Instrument .....	3-1
Receiving and Unpacking .....	3-1
Packaging and Storing .....	3-1
Installation .....	3-2
Precautions .....	3-3



<b>System Checkout</b> .....	<b>3-4</b>
Turning On the Spectrum Analyzer .....	3-5
Initial Normalization .....	3-6
Restoring the Factory Default Settings .....	3-7
The Initial Display .....	3-7
Control Panel Basics .....	3-9
Sounds .....	3-11
The Built-In Calibrator .....	3-12
<b>Making Your First Measurement</b> .....	<b>3-12</b>
Selecting a Channel Table .....	3-13
Typical CATV Measurement .....	3-13
Making Your First Non-CATV Measurement .....	3-15

---

## Operation Summary

<b>Operation Summary</b> .....	<b>4-1</b>
<b>Display Screen</b> .....	<b>4-1</b>
<b>Connectors, Controls, and Menus</b> .....	<b>4-3</b>
FREQ/MKRS .....	4-4
CTR-MEAS/TRKG .....	4-4
PEAK FIND .....	4-4
MKR/ $\Delta$ /OFF .....	4-4
MKR [ $\blacklozenge$ ] [ $\blacktriangleright$ ] Keys .....	4-4
CHAN/FREQ .....	4-5
SPAN/DIV .....	4-5
REF LEVEL .....	4-5
REF LEVEL [ $\blacktriangleup$ ] and [ $\blacktriangledown$ ] Keys .....	4-6
ZERO and MAX Keys .....	4-6
REF LVL STEP .....	4-6
Numeric Keys (0–9) .....	4-7
Terminator Keys (W, X, Y, Z) .....	4-7
Dot Key (•) .....	4-7
Backspace Key .....	4-7
Register Select and Save Keys (A, B, C, D) .....	4-8
SAVE ENABLE .....	4-8
MAX HOLD A&B .....	4-8
10/5/1 .....	4-9
LIN .....	4-9
PLOT .....	4-9
READOUT .....	4-9

- Demod Menu Items
  - Video Monitor      Mode (BROADCAST/SATELLITE)  
                             Sync Polarity  
                             Video Polarity

## Fragile Settings

Fragile settings are those that are reset during ANY reset cycle. Any settings not covered by the previous categories are FRAGILE. Resets occur as follows.

- During POWER DOWN/UP, INITIALIZE INSTRUMENT SETTINGS, and POWER-UP DIAG AND REBOOT cycles, settings are reset to user-defined power-up (if it exists) — otherwise, settings are reset to default values
- During RECALL LAST POWER DOWN cycle, settings are reset to last power-down settings
- During RECALL FACTORY DEFAULT POWER-UP, settings are reset to the factory default settings
- During RECALL USER DEFINED POWER-UP and RECALL NUMBERED SETTINGS cycles, settings are reset to the specified settings storage register

## Normalization values

The normalization values are modified by executing some or all of the normalizations. These values are only lost in the case of certain NVRAM failures. The values being used by the instrument may be set to default values with the service menus. Normalization values for the last executed (passed) normalizations are always restored during the POWER DOWN/UP and the POWER-UP DIAG AND REBOOT cycles. The other cycles do not affect the normalization values.

POWER .....	4-10
INTENSITY .....	4-10
LEVEL .....	4-10
AM VOL and FM VOL .....	4-10
VID FLTR .....	4-11
SINGLE .....	4-11
AUTO .....	4-11
[ ◀ ] [ ▶ ] .....	4-12

---

## Dedicated Controls

<b>Dedicated Controls .....</b>	<b>5-1</b>
<b>Fundamental Operations .....</b>	<b>5-3</b>
<b>SPAN/DIV .....</b>	<b>5-3</b>
Arrow Keys .....	5-4
Keypad Entry .....	5-4
MAX .....	5-5
ZERO .....	5-6
<b>Channel Entry .....</b>	<b>5-6</b>
Arrow Keys .....	5-6
Keypad Entry .....	5-7
<b>Frequency Entry (Normal Mode) .....</b>	<b>5-8</b>
FREQ/MKRS .....	5-8
Arrow Keys .....	5-8
Keypad Entry .....	5-9
<b>Frequency Entry (Non-CATV Mode) .....</b>	<b>5-10</b>
Arrow Keys .....	5-10
Keypad Entry .....	5-10
<b>REF LEVEL .....</b>	<b>5-11</b>
Arrow Keys .....	5-11
Keypad Entry .....	5-12
REF LVL STEP .....	5-13
<b>Enhanced Versatility .....</b>	<b>5-15</b>
<b>RES BW .....</b>	<b>5-15</b>
Arrow Keys .....	5-16
AUTO .....	5-17
<b>VIDEO FILTER .....</b>	<b>5-18</b>

## Appendix C: Global Resets

- Input Menu Items
  - Input Impedance
  - Reference Level Units
  - External Gain/Attenuation
  - External Gain/Attenuation Mode (ON/OFF)
  - dB $\mu$ V/M Measurement Distance
  - dB $\mu$ V/M Antenna Table
  - dB $\mu$ V/M Target Waveform
- Sweep/Trigger Menu Items
  - Video Sync Polarity
  - Video Line Triggering Mode (CONTINUOUS/KNOB/ENTERED)
  - Video Line Triggering Standard (NTSC/SECAM/PAL/OPEN)
- Display Menu Items
  - Ensemble Averaging Destination Waveform
  - MIN HOLD Destination Waveform
  - Ensemble Averaging Mode
  - Ensemble Averaging Number-of-sweeps
  - B,C Minus A Offset Mode, Display Acquisition Mode (PEAK/MAX-MIN)
  - Display Line Value
- CATV/Applications Menu Items
  - Bandwidth Display dBc Value
  - Occupied BW percent
  - Carrier-to-noise Reference Bandwidth
  - Normalized Noise Reference Bandwidth

## Table of Contents

<b>VERT SCALE</b> .....	<b>5-20</b>
10/5/1 .....	5-20
LIN .....	5-20
<b>SWEEP</b> .....	<b>5-21</b>
Arrow Keys .....	5-21
AUTO .....	5-23
SINGLE SWEEP .....	5-23
<b>LEVEL</b> .....	<b>5-24</b>
<b>DISPLAY STORAGE</b> .....	<b>5-25</b>
Display Registers .....	5-25
SAVE ENABLE .....	5-26
MAX HOLD A & B .....	5-31
<b>FREQ/MKRS</b> .....	<b>5-32</b>
MKR/ $\Delta$ /OFF .....	5-32
CTR-MEAS/TRKG .....	5-34
Arrow Keys .....	5-37
PEAK FIND .....	5-37
<b>Miscellaneous Controls</b> .....	<b>5-38</b>
PLOT .....	5-38
READOUT .....	5-39
INTENSITY .....	5-40
Rear Panel Trace Adjustments .....	5-40

---

## CATV Measurements

<b>CATV Measurements</b> .....	<b>6-1</b>
<b>CATV Preliminary Information</b> .....	<b>6-1</b>
Input Power Limitations .....	6-2
Initial Setup .....	6-3
<b>General (CATV) 2714 Mode</b> .....	<b>6-4</b>
Signal Types .....	6-5
Channel Tables .....	6-5
Selecting a Channel Table .....	6-6
Selecting a Text Channel .....	6-6
<b>CARRIER LEVELS Measurement</b> .....	<b>6-12</b>
Enable CARRIER LEVELS Measurement .....	6-12
<b>CARRIER SURVEY Measurement</b> .....	<b>6-14</b>
Enable CARRIER SURVEY Measurement .....	6-14
<b>MODULATION DEPTH Measurement</b> .....	<b>6-18</b>

- Audio Alert Setting
- Settings Protect Mode
- Signal Search Parameters

## Mode-related Settings

These are settings that are reset during some cycles and retained during others. The settings are reset as follows.

- During an INITIALIZE INSTRUMENT SETTINGS cycle, settings are reset to the values retained at the last physical power down
- During a POWER DOWN/UP cycle, settings are reset to the values retained at the last physical power down, unless a User-Defined Power-up exists — in that case, settings are reset to those stored in the User-Defined Power-up setting
- During a POWER-UP DIAG AND REBOOT cycle, settings are reset the same as during a POWER DOWN/UP cycle, but instead of the values resetting to those retained at the last physical power down, they reset as if a physical power down had just occurred
- During all other cycles, settings are not reset

The following are mode-related settings.

- Utility Menu Items
  - Spectral Display in Menus
- Marker/Freq Menu Items
  - Frequency Reference Mode (CENTER/START)
  - Counter Resolution
  - Frequency Tuning Mode (AUTO and TABULAR only, others revert to AUTO)
  - Entered Frequency Tuning Increment
  - Tabular Tuning Table
  - Frequency Offset
  - Frequency Offset Mode (ON/OFF)



Enable MODULATION DEPTH Measurement .....	6-19
<b>AURAL (FM) DEVIATION Measurement .....</b>	<b>6-20</b>
Enable AURAL (FM) DEVIATION Measurement .....	6-21
<b>CARRIER TO NOISE Measurement .....</b>	<b>6-22</b>
Enable CARRIER TO NOISE Measurement .....	6-23
<b>HUM/LFD Measurement .....</b>	<b>6-24</b>
Enable HUM/LFD Measurement .....	6-26
<b>FREQUENCY RESPONSE Measurement .....</b>	<b>6-27</b>
Running The Mode 1 Test .....	6-28
Running The Mode 2 Test .....	6-28
Enable FREQUENCY RESPONSE Measurement ...	6-29
<b>CTB/CSO Measurement .....</b>	<b>6-32</b>
Interactive Mode .....	6-33
Automatic Mode .....	6-33
Automatic With Pause Mode .....	6-33
Single-sweep Mode .....	6-33
Enable CTB/CSO Measurement .....	6-34
<b>CROSS MODULATION Measurement .....</b>	<b>6-41</b>
Enable CROSS MODULATION Measurement .....	6-41
<b>In-Channel Response Measurement .....</b>	<b>6-43</b>
Interactive Mode .....	6-43
Automatic Mode .....	6-44
Starting The Measurement .....	6-44
Running The Interactive Measurement .....	6-45
Running The Automatic Measurement .....	6-46
<b>Auxiliary Operations .....</b>	<b>6-47</b>
View Modulation (Field) .....	6-47
Line Modulation .....	6-48
View Picture .....	6-49
Listen .....	6-49

---

## The Menus

<b>The Menus .....</b>	<b>7-1</b>
<b>Using the Menus .....</b>	<b>7-1</b>
<b>Input .....</b>	<b>7-4</b>
Turning the Calibrator On and Off .....	7-5
Setting the RF Attenuation .....	7-5
Changing Reference Level Units .....	7-6

## Reset Cycle Description

Following is a list of all the possible reset cycles.

### **Power Down/Up Cycle**

Invoked by powering the instrument down and back up again.

### **Initialize Instrument Settings Cycle**

Invoked with [UTIL] [0].

### **Recall Last Power Down Cycle**

Invoked with [UTIL] [1] [0].

### **Recall Factory Default Power-Up Cycle**

Invoked with [UTIL] [1] [1].

### **Recall User Defined Power-Up Cycle**

Invoked with [UTIL] [1] [2] [W].

### **Recall Numbered Settings Cycle**

Invoked with [UTIL] [1] xx [W]. xx is one of a selection of stored settings designated by numerals 0-9 on 4 successive screens.

### **Power-Up Diag And Reboot Cycle**

Invoked with [UTIL] [5] [0] [9].

---

## Reset Categories

The 2714 has several distinct settings categories.

### **Precious Settings**

Precious settings are not reset by any reset cycle. The settings in this class can only be changed by manually setting each to its desired value. The following are precious settings.

- Measurement Channel
- Saved Waveforms
- Plot Configuration (including Comm Port, Plot Language, and Plot Speed)
- GPIB or RS-232 configuration
- Real-Time Clock Configuration

Accommodating External Amplification/Attenuation . . . . .	7-7
Accommodating a 50 $\Omega$ Source . . . . .	7-8
Setting the First Mixer Input Level . . . . .	7-9
Turning the Preamplifier ON/OFF . . . . .	7-10
Using the DBUV/M . . . . .	7-11
<b>MKR/FREQ . . . . .</b>	<b>7-19</b>
Setting Start and Stop Frequencies . . . . .	7-19
Using Markers to Set Start and Stop Frequencies . . . . .	7-20
Transposing Markers . . . . .	7-20
Changing the Knob Function . . . . .	7-21
Moving the Marker to the Next Higher or Lower Peak Marker to the Reference Level . . . . .	7-22
Selecting the Tuning Increment . . . . .	7-23
Center or Start Frequency . . . . .	7-24
Setting the Signal Threshold . . . . .	7-25
Counter Resolution . . . . .	7-25
Programmed Tuning . . . . .	7-26
Frequency Offsets . . . . .	7-27
<b>DSPL . . . . .</b>	<b>7-28</b>
Changing the Display Mode . . . . .	7-29
<b>Ensemble Averaging . . . . .</b>	<b>7-30</b>
Subtracting Stored Signals . . . . .	7-33
Changing Acquisition Mode . . . . .	7-37
Adding Titles and Labels . . . . .	7-38
Turning Graticule Illumination On and Off . . . . .	7-41
Displaying an External Source . . . . .	7-41
The Display Line and Limit Detector . . . . .	7-42
Activating Minimum Hold . . . . .	7-44
<b>APPL . . . . .</b>	<b>7-45</b>
Measuring Signal Bandwidths . . . . .	7-45
Measuring Average Noise . . . . .	7-47
Measuring Carrier-to-Noise Ratios . . . . .	7-48
Searching For Signals . . . . .	7-50
Measuring Occupied Bandwidths (OBW) . . . . .	7-52
Viewing Instantaneous Frequency Deviation . . . . .	7-56
<b>DEMOD . . . . .</b>	<b>7-58</b>
Listening To FM Transmissions . . . . .	7-58
Listening To AM Transmissions . . . . .	7-59
Listening To AM or FM Transmissions . . . . .	7-59
Video Demodulation . . . . .	7-60



# Appendix C: Global Resets

Settings on the 2714 can be reset in many ways. Some instrument settings are always reset, while others are never reset, and still others are reset during certain reset cycles only. This appendix includes a description of which settings are in each category, and when each category of settings is reset.

---

## Definitions

These definitions are included to make the following explanations more clear.

### **Reset**

To restore a setting to a previous state. This is what happens to the center frequency, for example, when power is removed and re-applied. The center frequency setting is RESET.

### **Reset Category**

Each setting belongs to one RESET CATEGORY, such as center frequency belongs to the fragile reset category. The categories are described later in this appendix.

### **Reset Cycle**

An operation that causes one of the reset categories to be operated on.

### **Retain**

The opposite of RESET. A setting is RETAINED for a particular RESET CYCLE if its value can be set to any allowable value and remains at that value after the RESET CYCLE completes.

<b>UTIL</b> .....	<b>7-61</b>
Menu-entered Control Settings .....	7-62
Save and Recall Settings and Displays .....	7-63
Recall Last Power-down Settings .....	7-64
User-defined Power-up Settings .....	7-64
Other User-defined Settings .....	7-65
Normalizing the 2714 .....	7-66
System Configuration .....	7-68
Configuring the Communications Port .....	7-69
Selecting the Screen Plotter Configuration .....	7-72
Selecting the Printer Configuration .....	7-73
Instrument Configuration .....	7-73
Setting the Minimum Signal Size .....	7-74
Sending Waveforms To a Computer .....	7-74
Turning PhaseLock On and Off .....	7-75
Frequency Corrections On and Off .....	7-75
The Spectral Display In Menus .....	7-76
Changing the Sweep Holdoff .....	7-76
Setting the Date and Time .....	7-77
Protecting Stored Settings .....	7-77
The File System .....	7-77
Protecting Files .....	7-79
Confirming Installed Options .....	7-80
Diagnostics and Adjustments .....	7-81
Aligning the Display .....	7-81
Service Normalizations .....	7-81
If You Lose NVRAM .....	7-83
Generating a Service Request .....	7-84
Printing The On-screen Readouts .....	7-85
<b>SWP/TRIG</b> .....	<b>7-85</b>
Free Running the Sweep Generator .....	7-86
Oscilloscope Trigger Modes .....	7-86
TV Line Trigger .....	7-88
TV Video Field Triggering .....	7-91
Setting the Sweep Rate .....	7-91
Manually Scanning .....	7-91
<b>USER DEF</b> .....	<b>7-92</b>

## Appendix B: System Messages

### TIMER INTERRUPT FAULT

Firmware/Hardware error. Possible malfunction of interrupt timer on processor board indicated. Contact your local Tektronix service center or representative if message persists after normalization.

### TOO MANY FILES OPEN

Firmware/Hardware error. Indicates that the maximum number of files is already open. Cannot open any more files at this time. Contact your local Tektronix service center or representative if message persists after normalization.

### UNCAL

Indicates the 2714 is operating in an uncalibrated state. Occurs under the following conditions.

- Sweep speed is too fast for a specified resolution BW, video filter, and span combination
- One or more critical normalizations have not been completed successfully

### UNCAL OFF

A change-of-state indicator briefly displayed when an uncalibrated state has been corrected and exited.

### UNCAL ON

A change-of-state indicator briefly displayed when an uncalibrated state has been entered.

### UNDEFINED ERROR CODE

Firmware/Hardware error. Returned error code has overrun established limits. Contact your local Tektronix service center or representative if message persists.

### UNDEFINED EVENT CODE

Firmware/Hardware error. Returned error code has overrun established limits. Contact your local Tektronix service center or representative if message persists.

### USE ANTENNA SETUP MENU FIRST

The antenna start/stop/increment frequencies must be set prior to editing the correction table.

### USER DEFINED PROGRAM IN PROCESS

A UDP is in progress. Reported primarily for GPIB purposes.

### USER DEFINED PROGRAM COMPLETE

A UDP has finished.

---

## External Input and Output

<b>External Input and Output</b> .....	<b>8-1</b>
<b>Mains Power</b> .....	<b>8-1</b>
<b>J101 — TV Sideband Analyzer Interface</b> .....	<b>8-1</b>
<b>J102 — External Trigger</b> .....	<b>8-2</b>
<b>J103 — Accessory Connector</b> .....	<b>8-3</b>
Pin 1 — External Video Input .....	8-3
Pin 2 — Chassis and Signal Ground .....	8-4
Pin 3 — Video Output .....	8-5
Pin 6 — Sweep Gate .....	8-5
Pin 7 — Sweep Ramp .....	8-6
<b>J104 — Digital Communications Port</b> .....	<b>8-7</b>

---

## Appendixes

<b>Appendix A: Broadcast AM, FM, &amp; TV Signal Sources</b> ....	<b>A-1</b>
<b>Appendix B: System Messages</b> .....	<b>B-1</b>
<b>Appendix C: Global Resets</b> .....	<b>C-1</b>
<b>Definitions</b> .....	<b>C-1</b>
<b>Reset Cycle Description</b> .....	<b>C-2</b>
<b>Reset Categories</b> .....	<b>C-2</b>
<b>Appendix D: Accessories &amp; Options</b> .....	<b>D-1</b>
<b>Accessories</b> .....	<b>D-1</b>
<b>Options</b> .....	<b>D-3</b>

---

## Index

---

## Change Information

The message may also be displayed in Signal Track mode with the Frequency Counter enabled when tracking a rapidly moving signal. Disabling the Frequency Counter may correct the problem. The instrument may also try to count random noise on the filter skirts resulting in this error message. Turning on the Video Filter or raising the Signal Threshold corrects the problem.

**SIGNAL OVER RANGE**

The signal peak is above the top of the CRT display. Lower the reference level.

**SINGLE SWEEP ARMED**

Instrument armed for single sweep.

**SINGLE SWEEP MODE**

Instrument in single sweep mode.

**SINGLE SWEEP TRIGGER**

Single sweep has been triggered.

**SIGNAL SEARCH COMPLETE**

Firmware routine finished.

**SIGNAL SEARCH IN PROCESS**

Firmware routine running.

**STAND BY**

A delay is required in the use of the instrument until this message disappears.

**START FREQUENCY CHANGED**

A change in the stop frequency necessitated a change in the start frequency.

**STOP FREQUENCY CHANGED**

Change in start frequency necessitated a change in stop frequency.

**STORAGE REGISTER EMPTY**

No data yet stored in the register accessed.

**TABLE CURRENTLY IN USE**

The table is currently in use, but the user may still delete it if desired.

**TABLE IS TOO LARGE TO EDIT**

The current combination of start/stop/increment setup frequencies results in a correction table with too many elements.





# List of Figures

Figure 1-1: Spectrum Analyzer Block Diagram .....	1-7
Figure 2-1: Carrier-to-noise Accuracy Without a Preselector ..	2-7
Figure 2-2: Carrier-to-noise Accuracy Using a Preselector ....	2-8
Figure 2-3: CTB Accuracy .....	2-9
Figure 2-4: CSO Accuracy .....	2-10
Figure 3-1: Display with Factory Default Power-up Settings ...	3-8
Figure 3-2: Normal On-screen Data Readouts .....	3-9
Figure 3-3: Typical Measurement Result Display .....	3-15
Figure 3-4: The Primary Controls .....	3-17
Figure 3-5: Calibrator Signal and Harmonics .....	3-18
Figure 3-6: Calibrator Signal Fundamental .....	3-22
Figure 4-1: Layout of the Text Screen in the Spectral Display Mode .....	4-2
Figure 4-2: Layout of the Text Screen in the Menu Display Mode .....	4-2
Figure 4-3: The Frequency/Marker Function Block .....	4-3
Figure 4-4: Fundamental Analyzer Controls .....	4-5
Figure 4-5: The Keypad .....	4-7
Figure 4-6: Display Register Control .....	4-8
Figure 4-7: Vertical Scale and Other Controls .....	4-9
Figure 4-8: Resolution BW and Sweep Control .....	4-10
Figure 4-9: The 2714 Back Panel .....	4-13
Figure 5-1: Example of a Waterfall Display .....	5-30
Figure 5-2: Typical Plotter Output Showing TV Channel Spectrum .....	5-39
Figure 6-1: CATV MEASUREMENTS Menus .....	6-4
Figure 6-2: Carrier Levels Measurement Results .....	6-13
Figure 6-3: Typical Carrier Survey Report Screen .....	6-17
Figure 6-4: Typical Frequency Response Display Without Reference .....	6-30
Figure 6-5: Typical Frequency Response Display With Reference .....	6-32
Figure 6-6: Typical CTB/CSO Measurement Results Display ..	6-36
Figure 7-1: The INPUT Menu .....	7-2

## Appendix B: System Messages

### SATELLITE VIDEO MNTR NOT INSTLD

2714 cannot sense presence of optional satellite (FM) video detector.

### SEARCH TERMINATED, MAX SIGNALS

Signal search is terminated if it detects more than 50 signals.

### SELECT TALK ONLY MODE FIRST

Screen plot front-panel operation requires the GPIB address mode to be talk only when the plot port is set to GPIB.

### SELECTED PROGRAM IS EMPTY

The selected user defined program is empty. No action is taken.

### SELECTED STORED SETTING IS EMPTY

Setting must be stored before it can be recalled.

### SELECTED TABLE IS EMPTY

The selected antenna correction factor table is empty.

### SETTING CORRUPTED

Requested stored setting has been deleted because of a corrupted data value. This message may also occur in general instrument operation if Settings Verify [UTIL] [5] [4] is turned ON. This selection checks all data transactions involving the instrument settings. No deletions occur in the general operation. Contact your local Tektronix service center or representative if message persists.

### SHORT HOLDOFF MODE NOT INSTLD

2714 cannot detect presence of Short Holdoff feature.

### SIGNAL CANNOT BE SET PROPERLY

Perform normalizations again. Contact your local Tektronix service center or representative if message persists.

### SIGNAL OUT OF IF PASSBAND

Frequency to be counted is not within one resolution bandwidth of the center frequency. Repeat CTR MEAS or use a wider resolution bandwidth filter. Performing a frequency normalization may also facilitate a count. Because of span and display storage inaccuracies, the signal may not be exactly centered in the digital display.

## List of Figures

Figure 7-2: Sweep/Trigger Menu with SWEEP RATE Selection Chosen .....	7-3
Figure 7-3: 75/50 $\Omega$ Matching Minimum Loss Pad .....	7-9
Figure 7-4: Equipment Setup for Field Strength Measurements .....	7-13
Figure 7-5: Average Signal Plus Noise and Average Signal-Plus-Noise Subtracted from the Current Sweep .....	7-34
Figure 7-6: Average MEAN Noise and MAX HOLD Signal-Plus-Noise .....	7-35
Figure 7-7: B, C Minus A Offset To Center .....	7-36
Figure 7-8: B, C Minus A Offset To Top .....	7-37
Figure 7-9: 2714 Plot With Title and Plot Labels .....	7-41
Figure 7-10: The SIGNAL SEARCH Frequency Range .....	7-50
Figure 7-11: Illustration of Occupied BW Measurement .....	7-53
Figure 7-12: Portion of U.S. Broadcast FM Band .....	7-54
Figure 7-13: OCCUPIED BW Mode With MAX HOLD .....	7-55
Figure 7-14: Instantaneous Frequency Deviation and Maximum Observed Deviation .....	7-57
Figure 7-15: Video Field Using Internal or TV Field Triggering .....	7-87
Figure 7-16: Video Signal Using Continuous Horizontal Line Triggering .....	7-89
Figure 7-17: Video Signal Using Knob-selectable Horizontal Line Triggering (VITS Visible) .....	7-90
Figure 8-1: Accessory Connector (J103) .....	8-3
Figure 8-2: Sweep Gate and Ramp Timing .....	8-6
Figure 8-3: RS-232-C Connector Pin Assignments .....	8-8
Figure 8-4: IEEE Standard 488 (GPIB) Connector Pin Assignments .....	8-8

**PRINTER OUT OF PAPER**

Reload printer paper.

**PROGRAM NOT EXECUTABLE**

The selected user-defined program is corrupted or too big to fit into available internal memory. Delete and resave the affected program.

**PROTECTED FILE**

Occurs when attempting to delete a file that is protected.

**QUERY NOT AVAILABLE**

Query attempted on function for which there is no query response.

**REAL TIME CLOCK HW FAILURE**

Firmware/Hardware error. Contact your local Tektronix service center or representative if message persists.

**REAL TIME CLOCK NOT INSTALLED**

2714 cannot detect presence of real-time clock.

**REFERENCE LEVEL HAS NEW RANGE LIMITS**

The reference level range limits have changed because the preamp or external atten/ampl mode is activated. The reference level itself does not change.

**REFERENCE NORMALIZATION FAILED**

Perform the reference normalization again checking for the presence of the correct external reference frequency and its correct entry from the keypad, if required. Contact your local Tektronix service center or representative if message persists.

**REGISTER VALUE NOT ALLOWED**

A storage register value was utilized that is not legal for the requested function. For example, the register value 1 was used with the GPIB command STORE. This attempts to store settings in the factory default power-up register, a reserved register.

**REMOVE PROTECTION FIRST**

The selected user-defined program cannot be deleted until its file protection is removed.

**RUNTASK: CANNOT START PROCESS**

Firmware error. Contact your local Tektronix service center or representative if message persists.



# List of Tables

Table 2-1: CATV Characteristics .....	2-1
Table 2-2: Frequency Related Characteristics .....	2-11
Table 2-3: Frequency/Amplitude Related Characteristics ....	2-14
Table 2-4: Amplitude Related Characteristics .....	2-16
Table 2-5: Input/Output Signal Characteristics .....	2-20
Table 2-6: Power Requirements .....	2-22
Table 2-7: Supplementary Characteristics Due to Options ...	2-23
Table 2-8: General Characteristics .....	2-23
Table 2-9: Environmental Characteristics .....	2-25
Table 2-10: Physical Characteristics .....	2-26
Table 4-1: The Sweep/Trigger (SWP/TRG) Menu .....	4-14
Table 4-2: The Utility (UTIL) Menu .....	4-15
Table 4-3: The Marker/Frequency (MKR/FREQ) Menu .....	4-20
Table 4-4: The Applications (APPL) Menu .....	4-22
Table 4-5: The Demodulator (DEMODO) Menu .....	4-30
Table 4-6: The User Definable (USER DEF) Menu .....	4-31
Table 4-7: The Display (DSPL) Menu .....	4-32
Table 4-8: The Input (INPUT) Menu .....	4-34
Table 6-1: Safe Maximum Signal Levels .....	6-2
Table 6-2: Signal Type Measurements .....	6-5
Table 6-3: STD .....	6-7
Table 6-4: HRC .....	6-8
Table 6-5: IRC .....	6-10
Table 7-1: Equivalent Decibel — Voltage Values .....	7-15
Table 7-2: AUTO Tuning Increment .....	7-24
Table 7-3: The File System .....	7-78
Table 7-4: Additional File System .....	7-79
Table D-1: Standard Accessories .....	D-1
Table D-2: Optional Power Cords .....	D-1
Table D-3: Optional Accessories .....	D-2

## Appendix B: System Messages

### NVM SEGMENTATION ERROR

Firmware/Hardware error. Contact your local Tektronix service center or representative if message persists.

### NVM VERSION MIS-MATCH

Firmware/Hardware error. Contact your local Tektronix service center or representative if message persists.

### ONLY WAVEFORMS DELETED

When settings you are attempting to delete are protected, only the saved waveforms are deleted.

### ONLY WAVEFORMS SAVED

When saving settings in a location containing previously protected settings, only the waveforms are saved.

### OUT OF RANGE

A value has been entered that is outside the permitted range. The instrument will default to the closest permissible value. If the message appears at times other than data entry a firmware/hardware error is probable. Contact your local Tektronix service center or representative if message persists.

### PLOT ABORTED

A new plot request has caused currently running plot to be aborted. New plot must be requested again in order to restart plot process and obtain new plot.

### PLOT COMPLETE

A plot operation has been finished.

### PLOT IN PROCESS

Signifies (for GPIB reporting) that a plot is in progress.

### POLYNOMIAL HAS NO SOLUTION

Firmware/Hardware error. Contact your local Tektronix service center or representative if message persists.

### PORT OFFLINE

Select ONLINE in proper port configuration submenu.

### PRINTER ERROR

Check the printer. Some printers return Printer Error for all conditions that need attention (offline, out of paper, etc.); refer to the printer manual.

### PRINTER IS NOT CONNECTED

Connect printer to appropriate port. Check printer cable.

## List of Tables

**NON-COMPATIBLE NVM FORMAT**

The firmware version was not compatible with the non-volatile memory. Consequently the NVM was re-initialized. Contact service center if message continues to repeat.

**NONE OF THE TRACES ARE ACTIVE**

A digitized waveform must be on to employ desired function.

**NORMALIZATION COMPLETE**

Normalization routine successfully finished.

**NORMALIZATION SUGGESTED**

Frequency normalization needed. Contact your local Tektronix service center or representative if message persists.

**NORMALIZED RESULT OUT OF RANGE**

Perform normalizations again. Contact your local Tektronix service center or representative if message persists.

**NORMALIZING**

Normalization routine running.

**NOT AVAILABLE WITH DBUV/M IDLE.**

The selected function is not available with DBUV/M mode idled. Select new reference unit to enable operation.

**NOT AVAIL IN SHORT HOLDOFF MODE**

Certain functions that require end of sweep processing are not available when in the Short Holdoff mode.

**NOT AVAIL IN WATERFALL MODE**

The selected function is not available in waterfall mode.

**NOT AVAIL W/DISPLAY STORAGE ON**

Function not compatible with digital display. Use analog display.

**NOT INSTALLED**

Feature not installed on this instrument.

**NVM CHECKSUM ERROR**

Non-Volatile Memory has been corrupted and consequently re-initialized. Contact your local Tektronix service center or representative if message persists.

**NVM FRAGMENTATION ERR**

Firmware/Hardware error. Contact your local Tektronix service center or representative if message persists.







# General Safety Summary

The general safety information in this summary is for operating and servicing personnel. Specific warnings and cautions can be found throughout the manual where they apply, and may not appear in this summary.

---

## Symbols and Terms

These two terms appear in manuals:

-  statements identify conditions or practices that could result in damage to the equipment or other property.
-  statements identify conditions or practices that could result in personal injury or loss of life.

These two terms appear on equipment:

- *CAUTION* indicates a personal injury hazard not immediately accessible as one reads the marking or a hazard to property including the equipment itself.
- *DANGER* indicates a personal injury hazard immediately accessible as one reads the marking.

This symbol appears in manuals:



Static-Sensitive Devices

## Appendix B: System Messages

### MALLOC: RAN OUT OF MEMORY

Memory allocation firmware/hardware error. Contact your local Tektronix service center or representative if message persists.

### MARKERS ARE OFF

Marker(s) must be turned on to obtain desired function.

### MARKER WOULD OVERWRITE NOISE VALUE

Enabling the marker would overwrite the saved Carrier-to-Noise or Normalized Noise value. Markers cannot be placed on a display saved with Carrier-to-Noise or Noise Norm'd modes enabled.

### MUST BE IN DELTA MARKER MODE

Turn on Delta Markers to obtain desired function.

### NO LISTENER

A screen plot front-panel operation was attempted to the GPIB port but no listen addressed devices were available. Place a listen-addressed device on the bus and reselect the operation.

### NO MODULATION ON SIGNAL

Occurs in zero span when CTR MEAS is attempted and there is no constant frequency modulation on the carrier.

### NO SIGNAL (NORMALIZATIONS)

Perform normalizations again. Contact your local Tektronix service center or representative if message persists.

### NO SIGNAL FOUND ABOVE THRESHOLD

There is no displayed signal exceeding the marker threshold value. Threshold can be reset using the MKR/FREQ Menu.

### NO SIGNAL AT CENTER OF DISPLAY

Firmware/Hardware error. Contact service center if message continues to repeat.

### NO SIGNAL AT COUNTER INPUT

Perform normalizations again. Contact your local Tektronix service center or representative if message persists.

### NOISE LEVEL LESS THAN 2DB

Measured system noise level is less than 2 dB above the 2714 noise floor. Noise power correction has been made by NOISE NORM'D or C/N mode algorithms in the 2714.

## General Safety Summary

These symbols appear on equipment:



**DANGER**  
High Voltage



Protective  
ground (earth)  
terminal



**ATTENTION**  
Refer to  
manual

---

## Specific Precautions

Observe all of these precautions to ensure your personal safety and to prevent damage to either the spectrum analyzer or equipment connected to it.

### Grounding the Spectrum Analyzer

This product is intended to operate from a power source that does not apply more than 250 V<sub>RMS</sub> between the supply conductors or between either supply conductor and ground.

**WARNING:** This product is grounded through the grounding conductor of the power cord. To avoid electric shock, plug the power cord into a properly wired receptacle. A protective-ground connection by way of the grounding conductor in the power cord is essential for safe operation. (IEC Safety Class I).

### DC Power Source

The 2714 can be powered from the optional model 2704/2705 DC-to-AC Inverter and external DC battery pack. The 2714 will run for approximately one hour on a fully charged 2705 Battery Pack, and for extended periods of time on alternate DC sources. See the 2704 DC-to-AC Inverter and 2705 Battery Pack instruction manual for further information.

### Power Disconnect

The main power disconnect is by means of the power cord, or, if provided, an AC power switch.

**ILLEGAL START/STOP/INC VALUES**

Illegal Start, Stop, or Increment values are present for the antenna correction factor table the user is attempting to edit. Either the initial non-usable values are present (the user has not attempted to enter his own values) or the values entered have some inconsistency, such as the start value being greater than the stop value.

**INACTIVE MARKER OFF SCREEN**

The frequency value of the inactive marker has been retained. The marker itself is out of the range of the display and is not visible.

**INSUFFICIENT MEMORY AVAILABLE**

Not enough memory (NVRAM) is available for the operation.

**INTERNAL REF AMPL TOO INACCURATE**

Perform reference amplitude normalization again checking for the presence of the correct external reference frequency and amplitude. Contact your local Tektronix service center or representative if message persists.

**INTERNAL REF FREQ TOO INACCURATE**

Perform reference frequency normalization again checking for the presence of the correct external reference frequency and its correct entry from the keypad. Contact your local Tektronix service center or representative if message persists.

**INTERRUPT FAULT AT FF**

Firmware/Hardware error. Contact your local Tektronix service center or representative if message persists.

**INTERRUPT FAULT**

Firmware/Hardware error. Contact your local Tektronix service center or representative if message persists.

**INVALID DEVICE NUMBER**

Firmware/Hardware error. Contact your local Tektronix service center or representative if message persists.

**INVALID FILE NUMBER**

Firmware/Hardware error. Contact your local Tektronix service center or representative if message persists.

**LAST PWR DOWN REG CHECKSUM ERR**

Last power down settings bad; defaults used. Contact your local Tektronix service center or representative if message persists.

## **Use the Proper Power Cord**

Use only the power cord and connector specified for your product. Use only a power cord that is in good condition. CSA Certification includes the equipment and power cords appropriate for use in the North America power network. All other power cords supplied are approved for the country of use.

## **Use the Proper Fuse**

To avoid fire hazard, use only a fuse of correct type, voltage rating, and current rating.

## **Use the Proper Voltage Setting**

Make sure the line selector is in the proper position for the power source being used.

## **Remove Loose Objects**

During disassembly or installation procedures, screws or other small objects may fall to the bottom of the mainframe. To avoid shorting out the power supply, do not power-up the instrument until such objects have been removed.

## **Provide Proper Ventilation**

Always allow at least 50.8 mm (2 in.) clearance adjacent to the ventilation holes at the sides, bottom, and back of the 2714.

## **Prevent Damage During Setup**

The 2714 can be damaged by incorrect AC supply voltages, RF inputs that exceed the maximum ratings, operation in very high temperatures or without adequate ventilation, immersion in liquids, and physical abuse.

## **Do Not Operate Without Covers**

To avoid personal injury or damage to the product, do not operate this product with covers or panels removed. To avoid the possibility of overheating, do not operate the 2714 in a carrying case.

## Appendix B: System Messages

### FREQ NORM SUGGESTED (SPAN DAC)

Perform frequency normalization. Contact your local Tektronix service center or representative if message persists.

### FREQUENCY NORMALIZATION FAILED

Perform frequency normalization again. Contact your local Tektronix service center or representative if message persists.

### FUNC NOT AVAIL IN DBUV/M MODE

Selected function is not available with the dB $\mu$ V/m measurement mode enabled. Functions not available include LIN vertical mode, FM and EXTERNAL display sources, and attempting to unsave the selected destination waveform. Choose new reference units to enable the selected operation.

### FUNC NOT AVAIL IN CURRENT MODE

Contact manual for proper instrument settings. This error message may appear, for instance, upon the invocation of instrument functions such as carrier to noise, noise normalized bandwidth, and antenna correction factors while in linear scaling mode. In these particular cases the vertical scaling mode would have to be changed to logarithmic before invoking the functions. Another case would be the invocation of a user-defined routine while in the user-defined routine acquisition mode. The acquisition mode must be exited before any routine can be activated.

### FUNCTION NOT AVAIL IN LIN MODE

Switch to LOG mode vertical scale to obtain proper functioning. This error message may appear upon the invocation of instrument functions such as carrier to noise, noise normalized bandwidth, and antenna correction factors.

### FUNCTION NOT AVAIL IN MAX SPAN

Signal track mode incompatible with MAX SPAN. Try smaller span.

### ILLEGAL COMMAND

Firmware error. Contact your local Tektronix service center or representative if message persists.

### ILLEGAL PARAMETER PASSED

Firmware error. Contact your local Tektronix service center or representative if message persists.

### **Remove From Operation**

If you have reason to believe that the instrument has suffered a component failure, do not operate the instrument until the cause of the failure has been determined and corrected.

### **Do Not Operate in Wet/Damp Conditions**

Using the 2714 in wet/damp conditions or inclement weather may result in electric shock or damage to the instrument.

### **Do Not Operate in Explosive Atmospheres**

To avoid explosion, do not operate this product in an explosive atmosphere unless it has been specifically certified for such operation.

**FILE NOT FOUND**

Occurs when attempting to access a file that does not exist.

**FILE SIZE ERROR**

Occurs when attempting to create a new file in NVRAM and the size of the new file is not the same as the size of the existing file. The most probable cause is that there is a version mismatch between the file system and the current firmware.

**FILE SYSTEM DIRECTORY FULL**

Occurs when attempting to store a file in the NVRAM and there are no more directory entries available.

**FILE SYSTEM FULL**

Occurs when attempting to store a file in the NVRAM and there is no more room to store the file.

**FIRST STEP MUST BE DONE FIRST**

Preceding step must be performed prior to selected one. Part of the reference normalizations are order-dependent.

**FORMATTING PLOT**

Downloading plot file to hardcopy device.

**FREQ OUT OF RANGE (NORMALIZATIONS)**

Perform frequency normalization again. Contact your local Tektronix service center or representative if message persists.

**FREQ NORM SUGGESTED (1ST LO)**

Perform frequency normalization. Contact your local Tektronix service center or representative if message persists.

**FREQ NORM SUGGESTED (FIND SIDE)**

Perform frequency normalization. Contact your local Tektronix service center or representative if message persists.

**FREQ NORM SUGGESTED (INNER PLL)**

Perform frequency normalization. Contact your local Tektronix service center or representative if message persists.

**FREQ NORM SUGGESTED (SET BEAT)**

Perform frequency normalization. Contact your local Tektronix service center or representative if message persists.

**FREQ NORM SUGGESTED (SET VCO)**

Perform frequency normalization. Contact your local Tektronix service center or representative if message persists.





# Safety Summary

***For qualified servicing personnel only  
Refer also to the General Safety Summary***

## **Do Not Service Alone**

Do not perform internal service or adjustment of this product unless another person capable of rendering first aid and resuscitation is present.

## **Use Care When Servicing With Power On**

To avoid personal injury from high current, remove jewelry such as rings, watches, and other metallic objects before servicing instrument. Do not touch exposed connections and components while power is on. Disconnect power before soldering, removing protective panels, or replacing components.

## **Use Caution When Servicing the CRT**

The CRT assembly should only be replaced by qualified personnel familiar with CRT servicing procedures and precautions. CRTs retain hazardous voltages for long period of time after power-down. Before attempting any work inside the instrument, discharge the CRT by shorting the anode to chassis ground. When discharging the CRT, connect the discharge path to ground and then the anode. Use extreme caution when handling the CRT. Rough handling may cause it to implode. Do not nick or scratch the glass or subject it to undue pressure during removal or installation. When handling the CRT, wear safety goggles and heavy gloves for protection.

## **Appendix B: System Messages**

### **DELETE EXISTING PROGRAM FIRST**

A user-defined program already exists in this register. It must be deleted before the new one can be stored.

### **DELETE EXISTING TABLE FIRST**

An attempt was made to store an antenna correction factor table in a file position that is already used. You must delete the file with the table deletion menu prior to attempting to store the new file.

### **DESTINATION WAVEFORM CONFLICT**

An attempt was made to enable two functions that use the same destination waveform. The display line, ensemble average, min hold, dBmV/M and waterfall mode use destination waveforms.

### **DIRECTORY ERROR IN FILE**

Firmware/Hardware error. Contact your local Tektronix service center or representative if message persists.

### **DISCONNECT INPUT SIGNAL**

Input signal needs to be removed in following step.

### **DISPLAY LINE OFF SCREEN**

The display line is out of range either at the top or bottom of the CRT display.

### **EDITING BUFFER IS EMPTY**

The local editing buffer for either the UDP or antenna tables is empty. Select Acquire Keystrokes in the User Def Program Utilities menu to begin acquisition. Select Begin Edit in the Edit Antenna Table menu to begin acquisition. If deletion of the editing buffer is being attempted, the error message is simply to inform the user that the selected action is invalid.

### **END OF FILE**

Firmware/Hardware error. Contact your local Tektronix service center or representative if message persists.

### **ENSEMBLE AVERAGE COMPLETE**

Signifies completion of an ensemble average process.

### **ERROR**

Firmware error. Contact your local Tektronix service center or representative if message persists.

### **FATAL ERROR IN FILE**

Firmware/Hardware error. Contact your local Tektronix service center or representative if message persists.

**Safety Summary**

**CANNOT OVERWRITE STORED WAVEFORM**

A waveform is already stored in this register. Old waveform(s) must be deleted first.

**CANNOT OVERWRITE STORED SETTING**

An instrument setting is already stored in this register. Old setting must be deleted first.

**CANNOT STORE — NV MEMORY FULL**

Must delete other settings if further storage is desired.

**CNTR SIGNAL OUT OF IF PASSBAND**

The signal in zero span is not above the threshold. Perform CTR MEAS again or use a wider resolution bandwidth filter. Performing a frequency normalization may also facilitate a count. Because of span and display storage inaccuracies, the signal may not be exactly centered in the digital display.

**COMM PORT NOT INSTALLED**

2714 cannot detect the presence of the communications port.

**COMMAND NOT IMPLEMENTED**

Feature not installed on this instrument.

**COUNTER FREQUENCY UNSTABLE**

Perform normalizations again. Frequency counter or input to it is unreliable. Contact your local Tektronix service center or representative if message persists.

**COUNTER NOT INSTALLED**

2714 cannot detect the presence of the counter.

**DATA ERROR IN FILE**

Firmware/Hardware error. Contact your local Tektronix service center or representative if message persists.

**DBUV/M MEASUREMENT MODE IDLE**

Destination waveform for DBUV/M is not being displayed and the correction calculation is disabled. The mode can be restarted by turning on the destination waveform register.

**DEFAULT DATA LOADED**

Since a file could not be read to load a data structure, the default values were loaded into the file and into the data structure.

**DELETE EDITING BUFFER FIRST**

The editing buffer must be deleted before the desired function or entry can be accomplished.

## Certificate of the Manufacturer/Importer

We hereby certify that the 2714 complies with the RF Interference Suppression requirements of Amtsbl.-Vfg 1046/1984.

The German Postal Service was notified that the equipment is being marketed.

The German Postal Service has the right to re-test the series and to verify that it complies.

TEKTRONIX

## Bescheinigung des Herstellers/Importeurs

Hiermit wird bescheinigt, daß der/die/das 2714 in Übereinstimmung mit den Bestimmungen der Amtsblatt-Verfügung 1046/1984 funkentstört ist.

Der Deutschen Bundespost wurde das Inverkehrbringen dieses Gerätes angezeigt und die Berechtigung zur Überprüfung der Serie auf Einhalten der Bestimmungen eingeräumt.

TEKTRONIX

## Appendix B: System Messages

### AMPLITUDE OUT OF CALIBRATION

The spectrum analyzer amplitude may be out of calibration. This message may be generated by the auto sweep rate measurement routine.

### AVERAGE NOISE TOO LOW

The average noise level in the Carrier-to-Noise or Noise Normalization measurement is below the bottom of the screen and cannot be digitized. To correct the problem, reduce the reference level to bring the noise level onto the screen.

### AVERAGE IN PROCESS

An ensemble average (not CONTINUOUS) is in process. Used to report event over GPIB.

### CALIBRATOR DOESN'T MATCH READOUT

The calibrator is enabled and an external attenuation or external frequency offset is enabled.

### CAN'T COUNT WITH CORRECTIONS OFF

Turn Frequency Corrections ON. The location of this selection is [UTIL] [4] [3].

### CANNOT CALC. VERT. SENSITIVITY

Perform amplitude normalization. Contact your local Tektronix service center or representative if message persists.

### CANNOT COUNT (VCO IF)

Perform frequency normalization. Either the VCO counter input or the IF counter input failure can cause this error to occur. Contact your local Tektronix service center or representative if message persists.

### CANNOT COUNT BEAT FREQUENCY

Perform frequency normalization. Contact your local Tektronix service center or representative if message persists.

### CANNOT DELETE FILE WHILE IN USE

Occurs when attempting to delete a file that is in use.

### CANNOT NORMALIZE PLL VCO

Perform frequency normalization. Contact your local Tektronix service center or representative if message persists.

### CANNOT OVERWRITE SAVED DISPLAY

Old data must be deleted or transferred to STORED SETTINGS before new data can be saved.

### **NOTICE to the user/operator:**

The German Postal Service requires that this equipment, when used in a test setup, may only be operated if the requirements of Postal Regulation, Vfg. 1046/1984, Par. 2, Sect. 1.7.1 are complied with.

### **HINWEIS für den Benutzer/Betreiber:**

Dies Gerät darf in Meßaufbauten nur betrieben werden, wenn die Voraussetzungen des Par. 2, Ziff. 1.7.1 der Vfg. 1046/1984 eingehalten werden.

### **NOTICE to the user/operator:**

The German Postal Service requires that Systems assembled by the operator/user of this instrument must also comply with Postal Regulation, Vfg. 1046/1984, Par. 2, Sect. 1.

### **HINWEIS für den Benutzer/Betreiber:**

Die vom Betreiber zusammengestellte Anlage, innerhalb derer dies Gerät eingesetzt wird, muß ebenfalls den Voraussetzungen nach Par. 2, Ziff. 1 der Vfg. 1046/1984 genügen.



# Appendix B: System Messages

The 2714 will display messages under the following conditions.

- Self-check routines detect abnormalities
- Incorrect information is entered
- An improper operation is attempted
- It is necessary to alert you to an operation in progress

The messages that may be displayed are contained in the following list. Their causes and corrections are indicated immediately below the message. If you are unable to correct an abnormal situation, contact your local Tektronix Service Center and report the message.

#### **1ST MEASUREMENT COMPLETE**

Go to the next step in the procedure.

#### **300HZ FILTER NOT INSTALLED**

2714 cannot detect presence of 300 Hz filter.

#### **ADDITIONAL NVRAM NOT INSTALLED**

Occurs when accessing a file located in extended NVRAM if the 2714 cannot detect the presence of the extended NVRAM.

#### **AMPL NORM SUGGESTED (VR PIN DAC)**

Perform amplitude normalization. Contact your local Tektronix service center or representative if message persists.

#### **AMPL OUT OF RANGE (NORMALIZATIONS)**

Perform amplitude normalization again. Contact your local Tektronix service center or representative if message persists.

#### **AMPLITUDE NORMALIZATION FAILED**

Perform amplitude normalization again. Contact your local Tektronix service center or representative if message persists.





# Introduction

# Appendix A: Broadcast AM, FM, & V Signal Sources





# Appendix A: Broadcast AM, FM, & TV Signal Sources



*Before connecting signal sources to the 2714, be certain the total signal strength is less than +70 dBmV. If in doubt, check with a broadband RF wattmeter or voltmeter.*

For some of the experiments in this manual, you need AM or FM modulated signals. The most readily available signals are AM and FM broadcasts. To receive AM or FM broadcast radio stations, you can plug a piece of wire directly into the center terminal of the input connector and hang the other end out a nearby window. If your building is not metal-framed, you can probably dead end the wire in the same room as the Spectrum Analyzer. The required length of wire will depend on the strength, location, and frequency of the transmitter, among other variables. 50 kW FM stations 40 miles distant have been received with a wire paper clip, straightened and inserted directly into the input connector.

TV stations and FM broadcasts can also be received on a standard television antenna or other suitable RF antenna. Before connecting any wire or antenna to the Spectrum Analyzer, ensure there is no static charge on it by momentarily grounding it to the input connector shell. If you are uncertain, use a voltmeter to confirm there are no high-level signals superimposed on the antenna system (such as from a nearby, high-power broadcasting station). Maximum total input to the 2714 must not exceed +70 dBmV.

If cable TV is available in your facility, it provides an ideal source of FM and TV signals. Using appropriate connectors, you can plug the cable directly into the Spectrum Analyzer.



# Introduction

This section describes this 2714 User Manual and introduces you to the basic concepts of RF spectrum analyzers and the 2714 Cable TV Spectrum Analyzer in particular.

---

## Manual Organization

### General

Sections 1 through 4 contain reference material that enables the beginning or experienced operator to safely power up and initially normalize the spectrum analyzer.

Sections 5 through 7 provide detailed explanations and some measurement examples that may be especially useful to the novice spectrum analyzer user. They are divided into small lessons that should be read while interactively using the spectrum analyzer and carrying out the instructions using the spectrum analyzer. In this way you quickly acquire the knowledge and skills necessary to confidently make accurate measurements. The end of one example and start of the next are indicated by a settings box that looks like this:

<b>8.75MHZ</b>	<b>(AUTO SWEEP)</b>	<b>M 11.45 MHZ</b>
<b>23.5DBMV</b>		<b>M 13.8 DBMV</b>
<b>600KHZ/</b>		<b>10 DB/</b>
<b>300KHZ RBW</b>		<b>STD CH 2</b>

The box shows what the control settings of the spectrum analyzer should be to continue with the example that follows it. The contents of the box resemble the spectrum analyzer's on-screen data readouts. Each lesson begins with the sweep control in AUTO mode. To remind you of this, (AUTO SWEEP) is shown in the top center of the box. The parentheses mean the enclosed item is not part of the normal on-screen readouts.



If you are inexperienced with spectrum analyzers, we recommend that you proceed serially through Sections 5, 6, and 7. Although each section can stand alone, they have been written to acquaint you with the most important features of the spectrum analyzer first, and to yield increased experience with previously-discussed controls as you proceed through the more advanced portions.

Four appendices and an index contain information about a number of topics useful, but not essential, to operating the spectrum analyzer.

### Specific

Section 1, *Introduction*, outlines this manual, contains a brief description of spectrum analysis, and reviews the characteristics of the Tektronix 2714 Cable TV Spectrum Analyzer.

Section 2, *Specifications*, lists the 2714 electrical, physical, and environmental specifications.

Section 3, *Getting Acquainted With Your Instrument*, enables you to safely apply power and signals to the spectrum analyzer. You become acquainted with the fundamental controls of the instrument and make your first measurements using a firmware-based CATV measurement routine and the built-in calibration signal. For additional information, we recommend Tektronix application note 26W-7037-1, *Spectrum Analyzer Fundamentals*.

Section 4, *Operation Summary*, provides most of the information needed for routine operation.

Section 5, *Dedicated Controls*, explains the features of the spectrum analyzer and the benefits you gain from each control and menu option as you go through examples. You learn to easily obtain accurate spectral and time-domain measurements.

Section 6, *CATV Measurements*, describes CATV requirements and offers step-by-step procedures to conduct automated measurement routines.

Section 7, *The Menus*, describes the 2714 menu-selectable, firmware-driven features.

Section 8, *External Input and Output*, explains the procedure to get signals in and out of the back panel of your spectrum analyzer.



# Appendixes



Appendix A, *Broadcast AM, FM & TV Signal Sources*, describes connecting the 2714 to various signal sources to accomplish the examples shown in the rest of the manual.

Appendix B, *System Messages*, describes abnormal instrument operating situations and the recommended resolution or correction.

Appendix C, *Global Resets*, provides the definitions, descriptions, and categories of the various reset procedures for the instrument settings.

Appendix D, *Accessories & Options*, describes all standard and optional accessories and options currently available for the 2714.

If you are already familiar with the spectrum analyzer, this manual can serve as a "how to" reference. Check the index or table of contents for the location of the subject of interest. Then set the spectrum analyzer according to the corresponding settings box, and refresh your memory by carrying out the example following the box.

---

## General Information

### What Is a Spectrum Analyzer?

There are several types of spectrum analyzers, but we will describe only the heterodyne, or scanning, spectrum analyzer. A scanning RF spectrum analyzer is essentially a radio receiver.

Tune a conventional FM broadcast receiver from one end of the band to the other. As you tune, plot the reading of the signal level meter versus frequency. The graph you produce is a frequency domain representation, or spectrum, of the FM broadcast band. The graph tells you at which frequencies the signals occur and how strong they are. If stations are too close together, you will not be able to get an independent meter reading for each individual station, and you will hear them simultaneously. This is because the intermediate frequency (IF) filter of the receiver has a bandwidth that is too wide to separate (resolve) the stations.

What you have just done is tune or scan the FM broadcast band with a resolution bandwidth equal to the bandwidth of the IF filter in your receiver. If you plot your measurements on graph paper with one centimeter divisions, making each division equal 1 MHz, the span/division of the resulting plot is then 1 MHz/div.

## External Input and Output

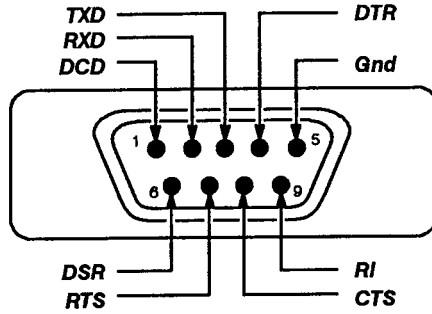

Figure 8-3: RS-232-C Connector Pin Assignments

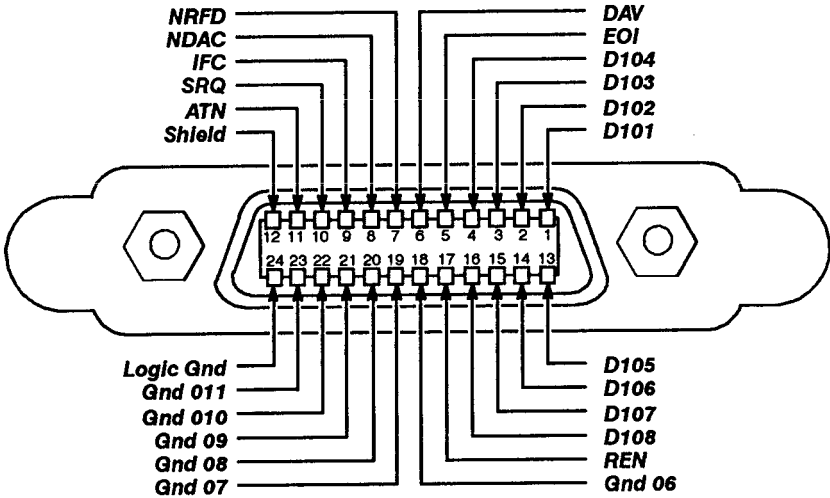

Figure 8-4: IEEE Standard 488 (GPIB) Connector Pin Assignments

If you stop tuning, the receiver no longer spans a range of frequencies, but is fixed at the currently selected frequency; it is in zero span mode. The output of the receiver depends on the signal coming through the IF filter at the selected frequency. If you plot the amplitude of the signal as a function of time (or view it on an oscilloscope-type display) you create a time-domain representation (signal amplitude versus time).

A spectrum analyzer performs similarly to the receiver except that the scanning is usually performed automatically (and faster than you do it manually) and there is a selection of IF bandwidths or resolution bandwidths to choose from. Multiple resolution bandwidths are needed because in some cases you may want to separate closely-spaced, narrow-band signals, while in others you may want to examine signals with larger bandwidths. There is a maximum speed at which a band can be accurately scanned with a resolution bandwidth of a given width (generally, the smaller the resolution bandwidth, the slower the speed). The spectrum analyzer can automatically select the fastest speed for you.

You can find additional information about basic spectrum analyzer concepts and definitions in Tektronix application note 26W-7037-1, *Spectrum Analyzer Fundamentals*.

### **What Can You Do With A Spectrum Analyzer?**

Spectrum analyzers measure how the power in an input signal is distributed in frequency. Therefore, you can use spectrum analyzers to determine signal amplitudes and frequencies, noise power, carrier-to-noise (C/N) ratios, signal or filter bandwidths, distortion (harmonic and intermodulation), FM deviation, and percent modulation. You can also use spectrum analyzers to detect spurious signals, align transmitters and receivers, and check specifications.

---

### **About the 2714**

The Tektronix 2714 is a cable TV, portable, radio frequency (RF), scanning spectrum analyzer designed for use in the field as well as the shop. It is light weight (less than 9.5 kg (22 lbs)) and can be equipped with a battery and inverter for use in locations without AC power.

The user interface is simple enough for the beginner but versatile enough to satisfy an expert. Fundamental CATV measurement parameters (center frequency, span/division, reference level, etc.) are auto-

the ramp marks the end of sweep; see Figure 8-2. The signal is usually used in conjunction with the video output to generate the horizontal deflection for an external video unit such as an XY oscilloscope or recorder.

- Continuing with the setup from the Sweep Gate paragraph, connect pin 7 to the X-axis input of your oscilloscope and the video output to the Y-axis. Place the oscilloscope in XY mode. Adjust the X-axis gain on the oscilloscope until the sweep just fills the screen. If the sweep is backwards, invert the X-axis input to reverse it.

The advantage in using the ramp to control the oscilloscope is that there is no difference in the time bases used by the 2714 and the oscilloscope. The disadvantage is that you cannot control the oscilloscope time base independently of the 2714.

---

## J104 — Digital Communications Port

The 2714 is equipped with a digital communications connector, labeled J104. The type of connector on your instrument depends on the communications option selected when the 2714 was purchased. If Option 08 (RS-232) was chosen, J104 is a 9-pin male D connector. If Option 03 (GPIB) was chosen, J104 is a 24-pin IEEE Standard 488 GPIB connector.

The connector pin-outs are shown in Figures 8-3 and 8-4. Signal levels, handshaking, protocols, and other matters of importance to digital communications are detailed in the 2714 Programmer Manual and the pertinent standards.

matically set when you select a channel table and channel. In non-CATV measurements, measurement parameters can be controlled directly with dedicated keys. In fact, as you will learn in Section 3, you can display a spectrum by touching only three controls. Call-up menus enable you to automate certain operations, such as bandwidth or carrier-to-noise ratio measurements, and to directly enter front-panel control settings. Measurement parameters and results are displayed on-screen.

To increase measurement flexibility, the spectrum analyzer has the following standard features.

- Automated CATV measurements
- True analog display in addition to digital storage
- Low input signal sensitivity with the built-in preamplifier activated
- Signals as large as 70 dBmV (+20 dBm) can be accommodated
- A frequency-corrected oscillator for high frequency accuracy
- Automatic selection of both sweep speed and resolution bandwidth
- True analog display (with 1  $\mu$ s/div sweep speed) that lets you see beats down in the noise
- Digital and time-domain functions
- AM/FM detection
- User-definable modes
- 300 Hz to 5 MHz resolution bandwidths in a 1–3–5 sequence

Post-detection digital sampling and storage is used with a unique max/min display mode that provides a close approximation of analog displays. Peak detection is also provided. It is possible to display up to four traces simultaneously and to perform ensemble statistics. A continuously updated “waterfall” display mode can be used to compare the four most recent spectral sweeps. 124 Kbytes of non-volatile random access memory (NVRAM) is provided to enable saving front-panel configurations and spectral sweeps for later review or operation. The exact storage capability depends on what else you are storing in the instrument (such as user-defined keystroke sequences).

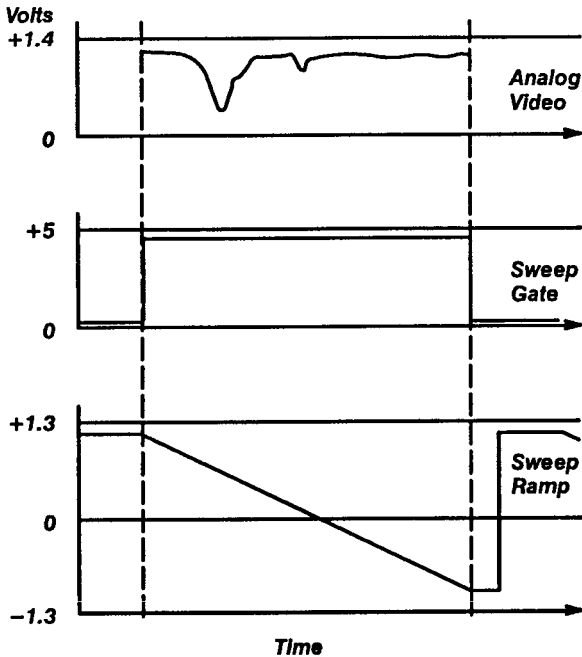

**Figure 8-2: Sweep Gate and Ramp Timing**

By using the video output to view the analog display, all four registers remain available for digital storage and display. You can have an analog display and four (different) digital traces.

- If your oscilloscope has a sweep magnifier or delayed sweep facility, use either one to obtain an enhanced view of the central signal peak on the oscilloscope without altering the spectrum analyzer settings.

The oscilloscope horizontal scale factor equals the 2714 span/division times the ratio of the 2714 and oscilloscope sweep speeds.

### **Pin 7 — Sweep Ramp**

Pin 7 of the Accessory Connector is the sweep ramp. The sweep ramp varies linearly from +1.3 V to -1.3 V and is proportional to the horizontal position of the sweep as it crosses the screen. The start of the ramp is synchronous with the start of the 2714 sweep. The bottom of

The instrument is very durable, but rough handling, or liquids, dust, or other contaminants inside the case can cause damage. The optional Travel Line package provides additional protection during transportation.

Optional capabilities result in even greater performance. Refer to Appendix D, *Accessories and Options*, for information on options currently available for the 2714.

### **NOTE**

*Because Tektronix continually improves its products, it is possible there may be a few differences in how your spectrum analyzer operates compared to the description in this document. Check with your local Tektronix field office or representative if further information is needed.*

Figure 1-1 shows the major working blocks of the 2714. As you proceed through this manual, you may find it useful to refer to this block diagram to understand operation of the various features of the instrument.

### Pin 3 — Video Output

Pin 3 of the Accessory Connector is the analog video output from the 2714. The analog video output is a 0 to 1.6 V signal representing the vertical deflection of the display on the 2714 with all registers turned off. 0 volts is the top graticule line and +1.6 V is the bottom line. The output signal range remains constant regardless of reference level, attenuation, and vertical scale. The signal can be used to drive an external oscilloscope or other video display unit. For example, in certain applications a device with a low- or high-persistence phosphor may be particularly useful.

- Connect pin 3 to an input channel of an oscilloscope. At the oscilloscope, select 0.2 V/div and 50 ms/div scale factors, invert the input, and trigger internally.

You may have trouble triggering because of the multiple signal peaks and blanking period of the video signal, but there should be a spectrum on the oscilloscope similar to the one on the 2714. If not, adjust your oscilloscope trigger and vertical position controls.

### Pin 6 — Sweep Gate

Pin 6 of the Accessory Connector contains the sweep gate. The sweep gate is a +5 V pulse whose leading edge is synchronous with the start of the 2714's sweep. The trailing edge marks the end of sweep. See Figure 8-2. The signal is usually used in conjunction with the video output (pin 3) to indicate when a new sweep is beginning.

- Continuing with the setup from the video output discussion, connect pin 6 to the external trigger input of your oscilloscope and select the external trigger mode positive slope. Adjust the oscilloscope trigger level control until the spectral display locks in place. Now turn off all the analyzer's registers. Compare the spectrum analyzer and oscilloscope displays.

If the image is as desired, follow the next step (this can be especially important when you are trying to view time-varying analog spectra).

- Turn on MAX HOLD in all the 2714 registers. Notice the analog trace is still displayed on the oscilloscope.



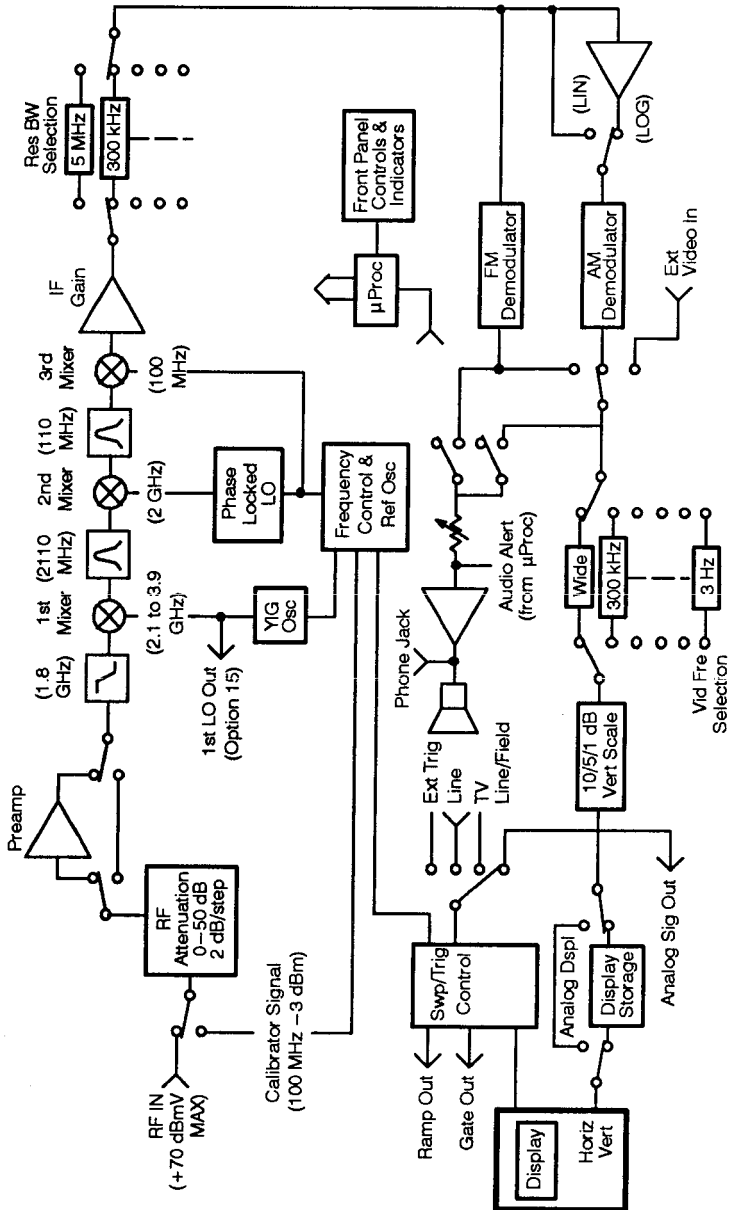

Figure 1-1: Spectrum Analyzer Block Diagram

## External Input and Output

The video signal, in this case, can be any signal limited to a 0–50 kHz band and an amplitude range of 0–1.4 V. The 2714 preamplifier, RF attenuator, mixer, resolution bandwidth filter, and log amplifier circuits are bypassed. The sweep rate and vertical scale circuits are utilized.

In addition, the digital storage remains active. This means you can use the 2714 to store images of external signals for comparison purposes, or compile statistical estimates of their parameters using ensemble averaging.

To experiment, you need a signal meeting the external input amplitude and frequency limits. Various signal generators can be used.

- Connect the signal source to pin 1 of the Accessory connector and its ground lead to pin 2. Toggle DSPL Menu item 7, DISPLAY SOURCE, to EXTERNAL.

The 2714 reverts to the display mode in zero span (there is no need to sweep the signal past the resolution bandwidth filter since these circuits are bypassed). The top graticule line is 0 V. The only information in the left on-screen readout that is meaningful is the sweep speed. The sweep speed is initially the speed in effect before you switched to EXTERNAL source; in this case, 50 ms/division. The only information in the right readout that is meaningful is the bottom line (EXT 175MV/) indicating that the external (EXT) input is being used with a vertical scale factor of 175 mV/div.

- Press [10/5/1] three times and notice that the scale changes to 87.5MV/, 17.5MV/, and back to 175MV/. Turn off all registers to view the analog signal, and then turn the D register back on.

The VERT SCALE and DISPLAY STORAGE function blocks remain operational. You can alter the display scaling, view analog or digital signals, compile ensemble statistics, or select other items from the DSPL Menu.

### Pin 2 — Chassis and Signal Ground

Pin 2 of the accessory connector is chassis and signal ground.

100.0MHZ	(AUTO SWEEP)	ATTN 10DB
28.8DBMV		VF WIDE
20.0MHZ/ 5MHZ RBW (AUTO)		10 DB/ CALIBRATOR



## J103 — Accessory Connector

The accessory connector, J103, is a 9-pin D connector, (not RS-232 compatible). The connector provides an interface for video I/O and the 2714's sweep gate and sweep ramp signals. Terminations are shown in Figure 8-1, and a discussion of each signal follows.

Within the signal discussions are bulleted instructions were prepared to guide you through applications using the Accessory Connector signals. The instructions were designed to be used consecutively, as provided.

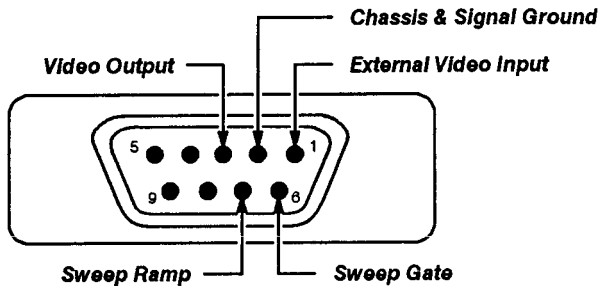

Figure 8-1: Accessory Connector (J103)

100.0MHZ	(AUTO SWEEP)	ATTN 10DB
28.8DBMV		VF WIDE
20.0MHZ/ 5MHZ RBW (AUTO)		10 DB/ CALIBRATOR

### Pin 1 — External Video Input

Pin 1 enables you to introduce an external video signal to the 2714, in effect giving it limited oscilloscope capabilities. It is also used to introduce the frequency markers from the 1405 TV Sideband Analyzer (see the previous discussion of J101).



# Specification

tors Manual or Tektronix publication 26W-7043 *Antenna To Tap...No Loose Ends*, for instructions on making measurements with the 1405/271x combination (treat the 2714 as though it is a 2710).

---

### J102 — External Trigger

The shell of this BNC input connector is at chassis ground. If you plan to use an external trigger (see SWP/TRIG in Section 7); this is where the trigger signal is input to the 2714. The trigger signal must be positive-going and rise above 100 mV for at least 0.1  $\mu$ s.



*To avoid damaging the 2714, combined AC plus DC trigger signal levels must not exceed 50 V peak.*

An external trigger signal starts a new sweep each time it rises above a threshold established by the setting of the LEVEL control, providing the previous sweep is completed and item 2, EXTERNAL, is selected from the Sweep/Trigger Menu.

A typical external trigger signal might be a +5 V pulse signifying that a transmitter has been keyed on, or that a receiver has detected a signal that rises above its squelch setting. For instance, to determine the spectrum of a gated CW signal, you could apply the gated CW to the 2714 input while triggering externally with the gating signal. The 2714 would then perform a spectral sweep only when the CW signal was present at its input.

To trigger the 2714 externally, connect the external trigger signal to the EXT TRIG connector and select item 2, EXTERNAL, from the Sweep/Trigger Menu. Turn the LEVEL control fully counter-clockwise and then rotate it slowly clockwise until a sweep occurs. If the external trigger is pulsing, the 2714 sweep should now remain in sync with it (if not, you may have to adjust the LEVEL control a bit more).

When you are finished, reselect the FREE RUN trigger mode.





# External Input and Output

The rear panel of the 2714 contains several input and output (I/O) connectors. One or more may not be used on your instrument, depending on which options you have installed.

---

## Mains Power

For safety, be sure to use a 3-wire, AC power cord, and be certain the ground conductor is properly connected. Adjacent to the power receptacle is the mains fuse with its size marked. If the fuse repeatedly blows, it is likely you have a hardware problem. If you suspect a problem, contact your local Tektronix Field Office or representative.

---

## J101 — TV Sideband Analyzer Interface

This output connector provides the first local oscillator (1st LO) signal to the Tektronix 1405 TV Sideband Analyzer. The connector is provided as part of Option 15. The 1405 is designed for testing video modulators, transmitters, and CATV headends. The sideband analyzer provides standard video signals to the input of the modulator, whose output is accurately measured using the 2714. Simply insert an SMA-to-SMA cable between the LO IN connector on the rear of the 1405 and J101 on the rear of the 2714.

You can also superimpose frequency markers generated by the 1405 on the sweep produced by the 2714. The markers consist of variable width "dips" in the 2714 sweep and are in addition to the intensified frequency markers internally generated by the 2714. To superimpose the markers, connect the Z AXIS OUT signal from the 1405 to the 2714 external video input (pin 1 of accessory connector J103; use pin 2 of J103 for signal ground). Turn the markers on or off with the push-buttons on the 1405, and control their width and depth using the WIDTH and INTEN controls on the 1405 front panel. Consult the 1405 Opera-



# Specification

This section lists the electrical, physical, and environmental characteristics of the spectrum analyzer, specifies the performance requirements for those characteristics, and provides supplementary information.

## Electrical Characteristics

Unless otherwise stated, the following tables of electrical characteristics and features apply to the spectrum analyzer after a 15 minute warm-up period (within the environmental limits) and after all normalization procedures have been carried out.

Information in the Performance Requirement column of Tables 2-2 through 2-8 is guaranteed and verifiable. Supplemental Information is intended to further explain a characteristic, its performance requirement, or to describe characteristic performance that is impractical to verify. Supplemental information is not guaranteed and may not be supported by a performance check procedure.

Changes to a characteristic because of the addition of an option are included in Table 2-7.

**Table 2-1: CATV Characteristics**

Characteristic	Description
Input Configuration	75 $\Omega$ Female F connector
Channel Selection	The visual and aural carriers are displayed when the channel number is entered or [ $\blacktriangle$ ] and [ $\blacktriangledown$ ] next to [CHAN/FREQ] are pressed
Tune Configuration	STD (73.603), HRC (73.605), IRC (73.612), and Custom <sup>1</sup>
Channel Range	0 to 999 <sup>1</sup>
Frequency Range	1 MHz to 1.8 GHz <sup>2</sup> , Preamp limited to 600 MHz

**1** Configured using 2714 Cable TV System Test Software.

**2** Dependent on selected channel table.



**Table 2-1: CATV Characteristics (Cont.)**

<b>Characteristic</b>	<b>Description</b>
Visual Carrier Frequency Measurement	Accuracy is dependent on the accuracy of the spectrum analyzer — see Frequency Accuracy in Table 2-2.
Method	Internal Counter
Resolution	1 Hz
Accuracy	$5 \times 10^{-7} \times \text{Carrier Frequency} \pm 10 \text{ Hz}, \pm 1$ Least Significant Digit @ 55.25 MHz (Ch 2) worst case is $\pm 38 \text{ Hz}$ @ 325.25 MHz (Ch 41) worst case is $\pm 173 \text{ Hz}$ @ 643.25 MHz (Ch 94) worst case is $\pm 332 \text{ Hz}$
Visual-to-Aural Carrier Frequency Measurement	Aural carrier measured relative to the visual carrier
Method	Internal Counter
Difference Range	1 MHz to 10 MHz <sup>2</sup> for an amplitude difference of $\leq 30 \text{ dB}$ and aural C/N $\geq 15 \text{ dB}$ (300 kHz RBW)
Resolution	1 Hz
Accuracy	$\pm 15 \text{ Hz}$ for visual-to-aural carrier difference $\leq 8 \text{ MHz}$
Visual Carrier Peak Level Measurement	Absolute peak amplitude of visual carrier measured with PREAMP OFF
Amplitude Range	$-18 \text{ dBmV}$ to $+58.8^3 \text{ dBmV}$ for visual C/N $\geq 30 \text{ dB}$ (300 kHz RBW)
Frequency Range	15 to 1015 MHz
Resolution	0.1 dB
Absolute Accuracy	$\pm 2.5 \text{ dB}$ for visual C/N $\geq 30 \text{ dB}$ (300 kHz RBW) and for FM signal C/N $\geq 33 \text{ dB}$ (100 kHz RBW) assumes flatness corrections are present
Relative Accuracy	$\pm 0.5 \text{ dB}$ Relative to adjacent channel $\pm 1.2 \text{ dB}$ Relative to all other channels

2 Dependent on selected channel table.

3 Total input power (all signals included) cannot exceed +70 dBmV.



# External Input and Output

Table 2-1: CATV Characteristics (Cont.)

Characteristic	Description
Visual-to-Aural Carrier Level Difference Measurement	Aural carrier level measured relative to the visual carrier
Difference Range	0 to 30 dB for aural C/N $\geq$ 15 dB (300 kHz RBW)
Resolution	0.1 dB
Accuracy	$\pm 0.75$ dB for aural C/N $\geq$ 15 dB (300 kHz RBW)
Modulation Depth Measurement (Typical)	Percent AM measured from sync tip to lowest white level found in 10 sweeps (the VITS line is used if it is defined in the channel table)
AM Range	50% to 95%
Resolution	0.1%
Accuracy	$\pm 2\%$ for visual C/N $\geq$ 40 dB (300 kHz RBW)
HUM/LFD Measurement (Typical)	Power line frequency is measured on an unmodulated visual carrier, and low frequency disturbance (LFD) is measured on the modulated carrier
AM Range	1% to 10% peak-to-peak
Resolution	0.1%
Accuracy	$\pm 1\%$ for Hum $\leq$ 5% and visual C/N $\geq$ 25 dB (300 kHz RBW) $\pm 2\%$ for Hum $<$ 10% and visual C/N $\geq$ 25 dB (300 kHz RBW)
Carrier to Noise Measurement (Typical)	Default noise floor is a normalized 4 MHz bandwidth measured relative to the visual carrier peak
Optimum Input Range	See Figures 2-1 and 2-2 at the end of this section
Maximum Range	See Figures 2-1 and 2-2 at the end of this section
Resolution	0.3 dB
Accuracy	See Figures 2-1 and 2-2 at the end of this section

- Time (hour and minute) when the first measurement will start
  - Set REPEAT INTERVAL to 6 HRS (UDP will repeat after every six hours)
  - Set RUN N TIMES to 5 (the number of times you want the UDP to repeat over a 24-hour period)
11. Store the routine in one of nine locations (registers) by pressing **[USER DEF] [6]** and selecting a storage location. For this exercise, assume that no UDP has already been stored in Slot 3. Store the routine in Slot 3. You cannot store a routine in a location in which another is already stored. You must first delete the prior routine.
  12. To prevent your routine from accidental erasure, press **[USER DEF] [9]** and select item 8, PROTECT, and then press **[3]**. Select item 7, DELETE, and notice the # next to your routine indicating that it is protected. Press **[3] [W]**. The message:

REMOTE PROTECTION FIRST

appears. To remove the protection, press **[BKSP] [8] [3]**. You can now delete the routine if you wish.

13. To execute the UDP, press **[USER DEF] [3]**. The display will return to the spectral display and also display the message:

WAITING FOR *Date Time* PROG 3  
PRESS USER DEF TO ABORT

### **NOTE**

*In creating the UDP, you actually stored data from each measurement as the UDP was being defined. If you want to retain only the data from the 24-hour test, be sure to remove all stored results prior to executing the UDP. Also, the SITE and OPERATOR NAMES should be defined prior to the UDP execution so the stored data will be properly nomenclatured.*

**Table 2-1: CATV Characteristics (Cont.)**

<b>Characteristic</b>	<b>Description</b>
CTB/CSO Measurement (Typical)	Composite triple beat (CTB) and composite second order (CSO) are measured relative to the visual carrier peak according to the NCTA recommended spectrum analyzer settings — SINGLE-SWEEP mode does not use all the NCTA recommended settings
Optimum Input Range	See Figures 2-3 and 2-4 at the end of this section
Maximum Range	See Figures 2-3 and 2-4 at the end of this section
Resolution	0.3 dB
Accuracy	See Figures 2-3 and 2-4 at the end of this section
Frequency Response Measurement (Typical)	For fixed-amplitude scrambling or no scrambling, system amplitude variations (flatness) are measured relative to a reference trace (stored during the frequency response reference setup)
Reference Trace Storage (Non-Volatile)	Up to 10 traces with spectrum analyzer states
Range	5 dB/div, fixed
Resolution	0.2 dB
Trace Flatness Accuracy	±0.75 dB
Carrier Survey	Absolute peak amplitude of each visual carrier measured and each associated aural carrier level measured relative to the measured visual carrier for the selected channels — characteristics are identical to the frequency (visual and aural) and level measurements (frequency is counted only if the FAST SURVEY is disabled (off))
FAST SURVEY Off	Visual carrier frequency measurement Visual to aural carrier frequency measurement Visual carrier peak level measurement Visual to aural carrier level difference measurement

The result over 24 hours will be five sets of 10 stored results representing a set for each time the UDP is repeated and the set stored when the UDP was first created.

To create the user-defined routine:

1. Press **[USER DEF]** and select item 9, USER DEF PROG UTILITIES. Select item 1, TITLE EDIT, and press **[W]** to begin editing. Enter a title of 24-HOUR LEVELS. The procedure is the same used to title a display (see Adding Titles and Labels in this section). The title can be up to 28 characters long. Remember to press **[X]** to store the title. Titling the routine is not mandatory (if you do not supply a title, the routine is named PROGRAM # by default) but does help you to recall what a routine is supposed to do.
2. Select item 0, ACQUIRE/EXIT KEYSTROKES, from the USER DEF PROG UTILITIES. This begins the accumulation of keystrokes. The spectral display reappears with the routine name superimposed and the following message.

ACQUIRE KEY STROKES                      0 BYTES

Each key that you press will now be recorded in the order in which it was pressed. This sequence of key strokes constitutes the bulk of the user-defined routines. The function of that key is also carried out as you watch. You can return to the USER DEF PROGRAM UTILITIES at any time by pressing **[USER DEF]**.

3. Press **[UTIL] [1] [1]** to recall the FACTORY DEFAULT POWER-UP.
4. Select a channel table.
5. Select a channel.
6. Run a CARRIER LEVELS measurement on the selected channel.
7. Store the current CARRIER LEVELS measurement results in NVRAM.
8. Repeat steps 4 through 7 for the other nine channels.
9. Press **[USER DEF] [9] [9]** to select TIME DELAY SETUP.
10. Set the following
  - Day of the week on which you want the UDP to run. The **[0]** key cycles through the days of the week



Table 2-1: CATV Characteristics (Cont.)

Characteristic	Description
FAST SURVEY On	
Visual Carrier	
Amplitude Range	-18 dBmV to +58.8 dBmV for C/N $\leq$ 30 dB (300 kHz RBW) <sup>4</sup>
Frequency Range	15 MHz to 1015 MHz
Resolution	0.3 dB
Absolute Accuracy	$\pm$ 2.7 dB for C/N $\geq$ 30 dB (300 kHz RBW) and for FM signal C/N $\geq$ 33 dB (100 kHz RBW) assumes flatness corrections are present
Relative Accuracy	$\pm$ 0.8 dB relative to adjacent channel $\pm$ 1.5 dB relative to all other channels
Aural Carrier	
Difference Range	0 to 30 dB for C/N $\geq$ 15 dB (300 kHz RBW)
Resolution	0.3 dB
Accuracy	$\pm$ 1.1 dB for C/N $\geq$ 15 dB (300 kHz RBW)
Aural <FM> Deviation (Typical)	Peak FM deviation measured for the selected channel
Range	10 kHz to 50 kHz, usable to 80 kHz
Accuracy	$\pm$ 4 kHz
Cross Modulation (Typical)	Peak of the fundamental component of the third order distortion at horizontal sync frequency (AM) measured on unmodulated visual carrier — add 3.9 dB for correction to the NCTA recommended synchronous square-wave modulation procedure
Range	52 dB, usable to 65 dB
Resolution	0.1 dB
Accuracy	$\pm$ 2 dB for cross modulation <40 dB $\pm$ 3 dB for cross modulation <52 dB

**4 Total Input power (all signals included) cannot exceed +70 dBmV.**

## The Menus

The spectral display reappears, but it does not appear to be updating. Turn the inner **LEVEL** control knob and watch the screen carefully. A portion of the display updates as you turn the knob. In this mode, the knob controls the horizontal sweep position.

Turn the inner **LEVEL** control knob slowly from fully counter-clockwise to fully clockwise, and watch the screen update. This feature enables you to carefully examine a small portion of the spectrum. It is also convenient for manually scanning a broadcast or communications band while listening to demodulated signals — the 2714 acts like a radio receiver. The operator can stop at any station since the sweep is being manually controlled..

Toggle the manual scan mode off by selecting item 7 again.

---

## USER DEF

<b>100.0MHz</b>	<b>(AUTO SWEEP)</b>	<b>ATTN 12DB</b>
<b>28.8DBMV</b>		<b>VF WIDE</b>
<b>20MHz/</b>		<b>10 DB/</b>
<b>5MHz RBW (AUTO)</b>		

The User-Definable menu enables you to store and execute user-definable sequences of keystrokes called routines or programs. The routines are intended to permit a series of operations to be carried out with only two keystrokes. Press the USER DEF menu button and select the routine you want to run. This feature is particularly useful when you have to make a series of repetitious measurements.

Before you can use routines they must be created, and each routine must have a well-defined starting point. One good way to ensure the routine starts with the correct instrument settings is to begin by recalling a specific group of settings. Another way is to start with a known group of settings (for example, the factory or user-defined power-ups) and manually change them to the configuration at which your routine begins (this can be done within the routine, but it uses up additional memory).

In the following example, we shall create a user-defined routine to perform CARRIER LEVELS measurements on 10 channels at six-hour intervals. The resultant UDP will execute a 24-hour test.

Table 2-1: CATV Characteristics (Cont.)

Characteristic	Description
Listen (Typical)	The aural carrier for the selected channel is demodulated
Output	Speaker or headphones with volume control
Demodulation Type	FM
Sweep	Displays instantaneous peak FM deviation
View Picture (Typical)	The visual carrier, NTSC or PAL format depending on the selected channel, is demodulated
View Modulation (Field) (Typical)	One video field of the selected channel video is displayed
View Modulation (Line) (Typical)	The VITS line is displayed — if no VITS line is specified in the channel table, line 17 is displayed
TV Line Selection	Selectable using the FREQ/MKRS knob during View Line Modulation function
Line Format	NTSC or PAL
Line Range	1 to 525 (NTSC), 1 to 625 (PAL)
Sweep Time	10 $\mu$ s/division
In-channel Response	
Range	$\pm 3$ dB (the auto test is run in 1 dB/div)
Resolution	0.1 dB
Accuracy	$\pm 0.5$ dB, Auto mode $\pm 0.8$ dB, Interactive mode

\* less than 60  
can maybe add  
(say 2dB @ 20  
30 channels)

\* greater than  
you HAVE to  
SUBTRACT

When using the keypad-entered lines, the tuning knob controls frequency instead of the line number.

## TV Video Field Triggering

Item 5, TV FIELD, of the Sweep/Trigger menu is the second of two internal triggering modes that are particularly useful for time domain analysis of television signals. Call up the Sweep/Trigger menu and choose item 5. The display is now being triggered by the TV vertical sync pulse that occurs near the beginning of each field. Using the SWEEP arrow keys, slow the sweep rate to 2 msec/div. The display resembles Figure 7-15. You can now see an entire frame of video information with the start of the frame at the left of the display. The frame does not slip sideways as it does in the LINE trigger mode, because the sweep generator is locked to the displayed signal itself.

You can eliminate the dark vertical spaces in the display by turning off the readouts.

## Setting the Sweep Rate

Slow the sweep rate without using SWEEP [▲] and [▼]. Call up the Sweep/Trigger menu and choose item 6, SWEEP RATE. Following the prompt, enter 5 msec/div. The 2714 reverts immediately to the display mode and you can see three whole video frames. This feature enables you to conveniently set sweep rate when you are already working in the Sweep/Trigger menu and may have turned off the readouts.

Return to the FREE RUN mode by pressing [SWP/TRIG] [0].

## Manually Scanning

100.0MHz	(AUTO SWEEP)	ATTN 12DB
28.8DBMV		VF 300KHz
1.0MHz/		10 DB/
300KHz RBW (AUTO)		

Center a strong video carrier, and then call up the Sweep/Trigger menu and select item 7, MANUAL SCAN.

**CARRIER-TO-NOISE ACCURACY WITHOUT A PRESECTOR PREAMP OFF**

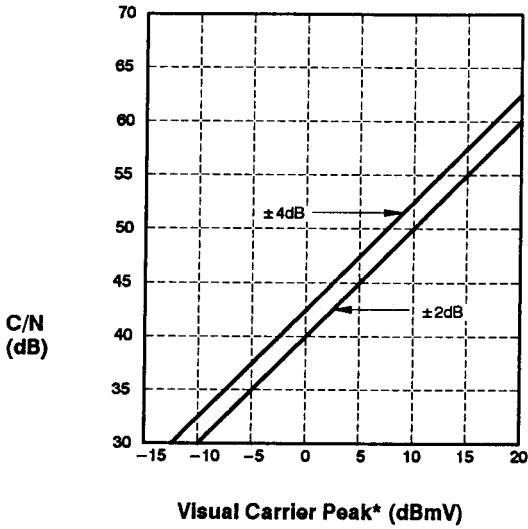

**CARRIER-TO-NOISE ACCURACY WITHOUT A PRESECTOR PREAMP ON**

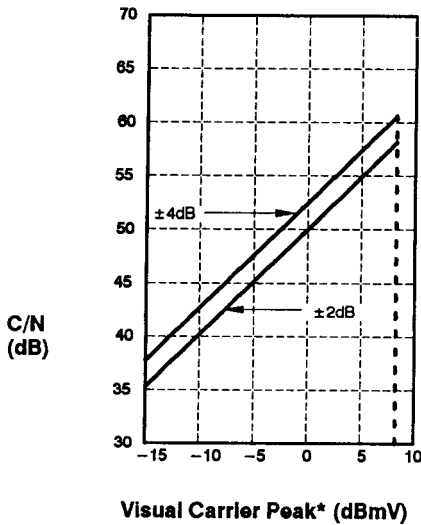

\* per channel, assuming 60 channel system.

**Figure 2-1: Carrier-to-noise Accuracy Without a Preselector**

## The Menus

The display is not as bright as it was in the CONTINUOUS mode, because the 2714 is triggering on, and displaying, only one horizontal line out of every 525. If the display is too dim, adjust the INTENSITY control.

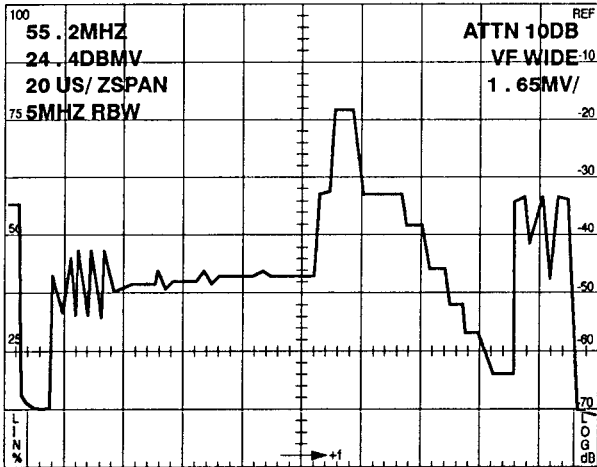

**Figure 7-17: Video Signal Using Knob-selectable Horizontal Line Triggering (VITS Visible)**

When knob-selectable TV line triggering is active, pressing **[MKR/FREQ] [2]** allows the knob function to be changed from frequency control to marker control or video line selection. This is a great convenience if you want to change TV channels. See Changing the Knob Function earlier in this section for more information.

Again call up the SETUP TABLE. If you select item 2, KEYPAD ENTERED LINE, the sync pulse indicated at the end of the line will be used as the trigger. Select item 3, KEYPAD ENTRY, and enter number 279 from the numeric keypad. The number you enter appears at the end of the KEYPAD ENTERED LINE. This number also changes when you operate in the knob-selectable mode; it shows the number of the sync pulse last used as the trigger.

Press **[2]** and return to the waveform display. On most U.S. NTSC stations you now see the VITS for the second picture field.

**CARRIER-TO-NOISE ACCURACY USING A PRESELECTOR PREAMP OFF**

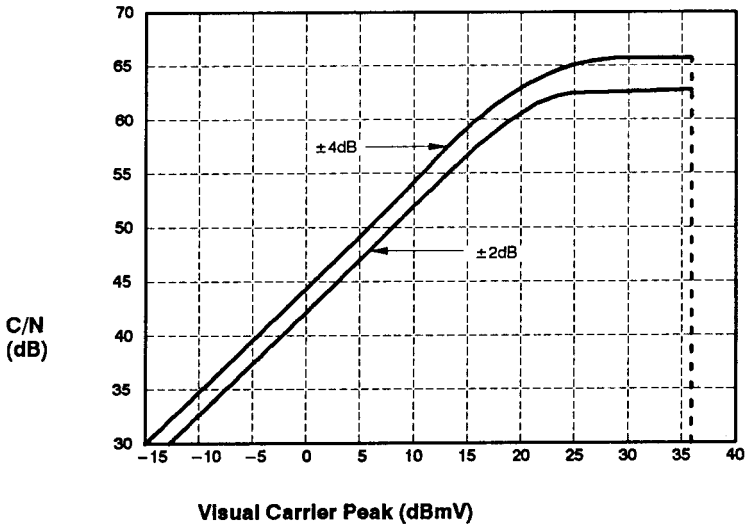

**CARRIER-TO-NOISE ACCURACY USING A PRESELECTOR PREAMP ON**

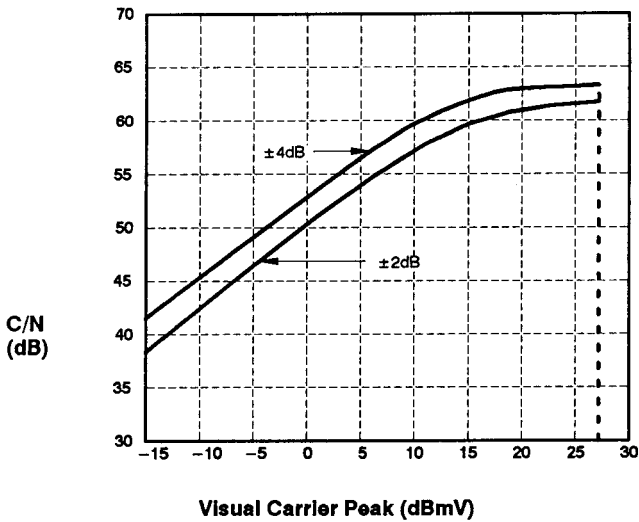

**Figure 2-2: Carrier-to-noise Accuracy Using a Preselector**

The screen should resemble Figure 7-16. In CONTINUOUS mode, the sweep generator is triggered by the first pulse that occurs after the 2714 enters the ready-to-be-triggered state. In other words, after the 2714 completes the current sweep, it enters the ready-to-be-triggered state, and is re-triggered by the first horizontal sync pulse that comes along. Thus, a different sync pulse generally triggers each sweep. The video signals following each sync pulse are not quite the same, but are never-the-less displayed on top of each other. The result is an intense, but fuzzy, display.

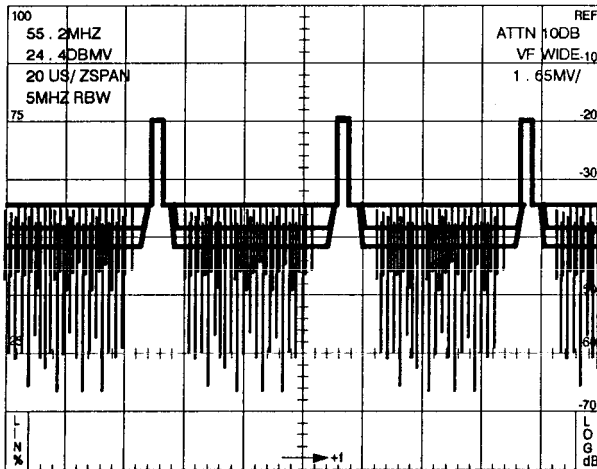

**Figure 7-16: Video Signal Using Continuous Horizontal Line Triggering**

Call up the SETUP TABLE again and choose item 1, KNOB SELECTION. Return to the spectral display. The tuning knob now controls which pulse is used. Pulses are numbered from 1 to 1023. The current line number (horizontal video line number and sync pulse number are the same) is displayed at the bottom of the right on-screen column. If more than one sync pulse is displayed, the number is that of the pulse nearest the left edge of the screen.

Turning the knob clockwise increases the line number and counter-clockwise decreases it. Turn to about line 17 to view several lines including the vertical interval test signal (VITS). This signal is usually present between lines 15–20 in the U.S. (see Figure 7-17).



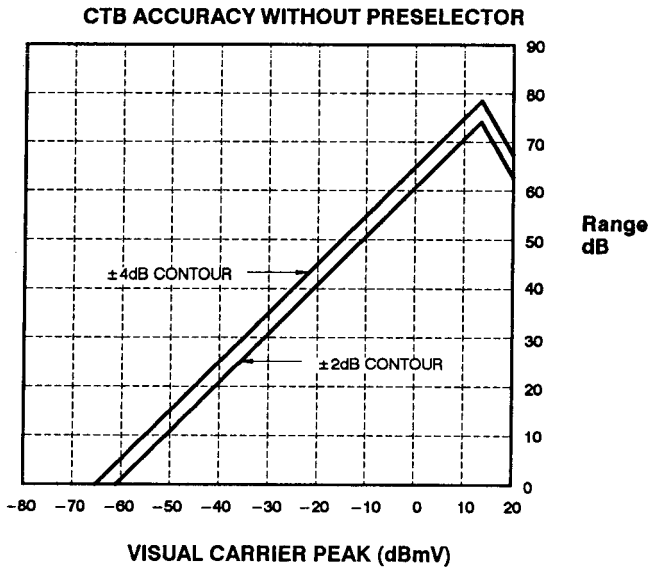
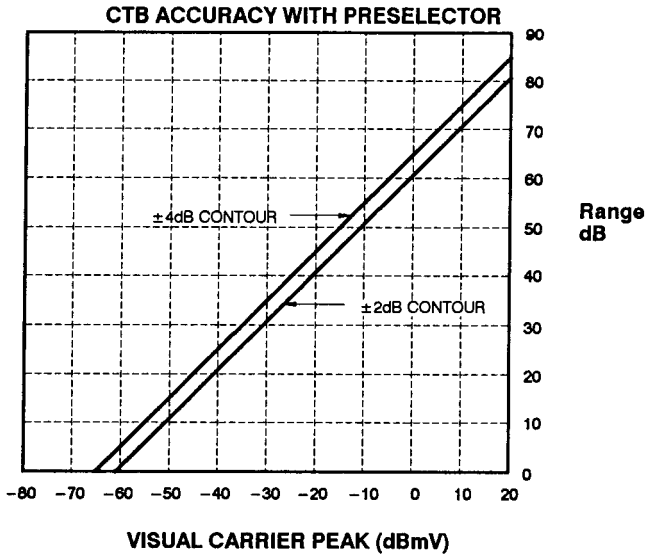

Figure 2-3: CTB Accuracy

voltage. The display may be slowly drifting or stationary now. TV sweep rates are nearly harmonically related to line frequency, but small, fractional Hertz differences create the slow drift.

Turn on the readouts.

### TV Line Trigger

100.0MHz	(AUTO SWEEP)	ATTN 12DB
28.8DBMV		VF 300KHz
1.0MHz/		10 DB/
300KHz RBW (AUTO)		

Item 4, TV LINE, of the Sweep/Trigger menu is one of two internal triggering modes that are particularly useful for time-domain analysis of television signals. A horizontal sync pulse begins each TV line. You can designate the TV line standard in use (NTSC, PAL, SECAM, or OPEN) and how the line is selected using item 9, SETUP TABLE. When CONTINUOUS line triggering is selected, any sync pulse will trigger the sweep. KNOB SELECTABLE and KEYPAD ENTRY modes enable you to select a particular horizontal sync pulse as the trigger signal. The selected line is displayed at the bottom of the right on-screen readout column. Choosing any HORIZONTAL LINE TRIGGERING mode from the SETUP TABLE also selects the TV LINE trigger mode.

To see TV line triggering work, connect an antenna or cable drop to the 2714 as outlined in Appendix A. Change the resolution BW to 5 MHz, and tune to a strong TV video carrier. Ensure the signal peak is close to the reference level.

Call up the Sweep/Trigger menu and select SETUP TABLE, item 9. Repeatedly select item 4, TV LINE STANDARD, until the TV line standard appropriate to your signal appears. Use the OPEN (1024 line) setting for non-standard systems.

Items 0 through 3 of the SETUP TABLE determine which sync pulse(s) is used. Choosing any of them also selects item 4, TV LINE mode, from the Sweep/Trigger menu. Select item 0, CONTINUOUS, and then return to the spectral display. Turn off digital storage and select zero span. Enter LIN mode, and change the sweep rate to 20  $\mu\text{sec}/\text{div}$  (sweep rate is indicated in the left-hand readout column).

**CSO ACCURACY WITH PRESELECTOR**

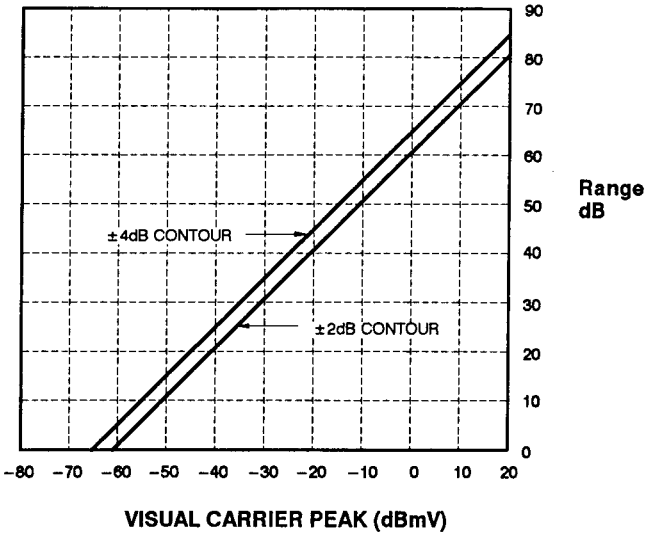

**CSO ACCURACY WITHOUT PRESELECTOR**

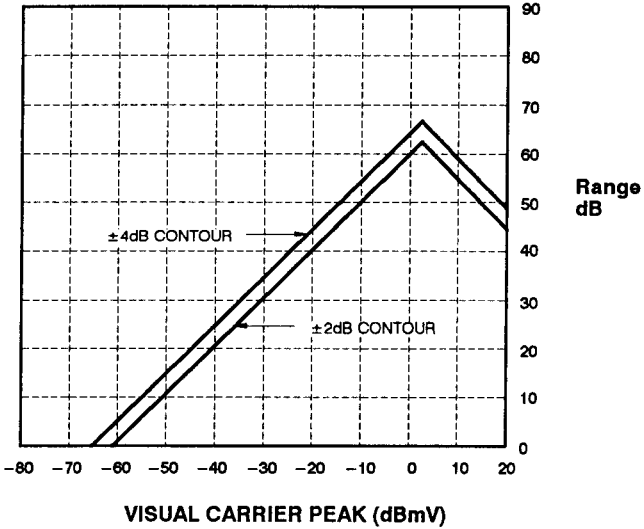

**Figure 2-4: CSO Accuracy**

The screen displays one field of video information. The dark vertical spaces in the waveform are caused by the time taken to write the on-screen readouts. Turn off the readouts. The waveform on screen should resemble Figure 7-15, except it will be sliding across the screen because the sweep generator is free running

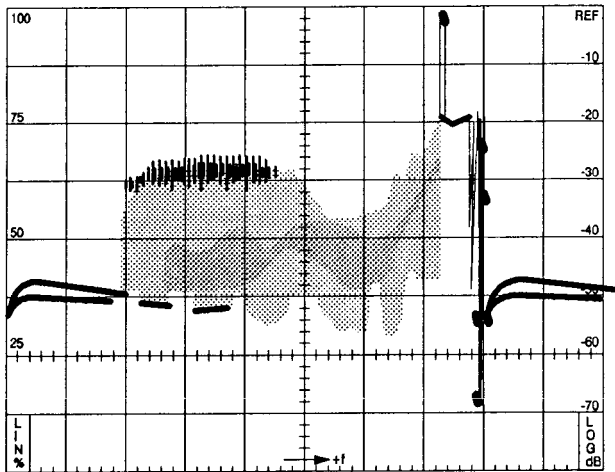

**Figure 7-15: Video Field Using Internal or TV Field Triggering**

Select item 1, INTERNAL, from the **SWP/TRIG** menu, and slowly rotate the LEVEL control until the display is stationary. The sweep is now being triggered by the vertical sync pulse.

External triggering is usually chosen for pulsed signal analysis when there is an externally available gate signal signifying that the signal to be examined is present at the 2714 input (for example, the keying signal from an RF transmitter or the squelch signal in a receiver — if the gating signal is not available, you might trigger internally). The External trigger signal is applied through a BNC connector (J102) on the back of the 2714; its amplitude can be from 100 mV to 50 volts. See Section 8 for additional information.

Without changing any other control settings, select item 3, LINE, from the **SWP/TIG** menu. If the screen goes blank, readjust the LEVEL control. The sweep is triggering on a sample of the AC power line

Table 2-2: Frequency Related Characteristics

Characteristic	Performance Requirement	Supplemental Information
Channel		Tuned with keypad, [CHAN/FREQ] [▲] and [CHAN/FREQ] [▼] according to the selected channel table
Frequency		
Range	9 kHz to 1.8 GHz	Tuned with keypad, [CHAN/FREQ] [▲] and [CHAN/FREQ] [▼] FREQ/ MARKERS knob, UTIL menu, or MKR/FREQ menu
Accuracy	$5 \times 10^{-7}$ of center frequency $\pm 10$ Hz $\pm 1$ least significant digit	Assume zero drift since last normalization procedure
Drift		
Long Term (One Year)		$\pm 2$ PPM/Year
Short Term (SPAN/DIV $\leq 20$ kHz)	$\leq 400$ Hz	With frequency corrections enabled
Readout Resolution		1 kHz or 1 Hz (counter readout), menu selectable

pulsed signals, it may be advantageous to trigger the sweep from some characteristic of the input signal, or from another signal related in a fixed way to the input signal.

The Sweep/Trigger menu also enables you to specify the sweep rate and enter the manual scan mode.

### Free Running the Sweep Generator

Call up the Sweep/Trigger menu by pressing [**SWP/TRIG**].

Choose item 0, FREE RUN, to place the 2714 sweep generator in the free running, or continuous, mode. This is the default setting, and is usually satisfactory for analyzing continuous signals. It is also a good mode for examining the time domain representation of CW and noise-like signals.

### Oscilloscope Trigger Modes

Just as on a conventional oscilloscope you can choose the input signal, an external signal applied at the back panel of the 2714, or the AC power line as the trigger source. You do this by selecting INTERNAL, EXTERNAL, or LINE trigger from the **SWP/TRIG** menu.

The INTERNAL, EXTERNAL, and LINE trigger modes cause the sweep generator to start a new sweep when the trigger signal amplitude crosses a threshold determined by the setting of the LEVEL control (inner knob to the left of **SWP/TRIG**). If the 2714 is placed in zero span and linear amplitude mode, the resulting waveforms resemble those that you would see on an oscilloscope (detected signal amplitude vs. time).

Internal triggering requires the signal to be at least one division in amplitude, and is most often used for time domain analysis.

The LEVEL control adjusts a threshold so that the sweep begins when the amplitude of the input signal crosses that threshold.

If internal triggering is used for spectral analysis, the triggering signal must be tuned to the left edge of the spectral display.

Connect an antenna or cable to the **RF INPUT** of the 2714 as outlined in Appendix A. Tune to a strong television videocarrier and adjust the signal height to near the reference level. Set the 2714 to LIN mode, zero span, and 5 MHz resolution bandwidth. Set the sweep rate to 2 msec/div, and deactivate all storage registers.

**Table 2-2: Frequency Related Characteristics (Cont.)**

<b>Characteristic</b>	<b>Performance Requirement</b>	<b>Supplemental Information</b>
<b>Frequency Span/Div</b>		
Range		Selections in a 1–2–5 sequence from 100 MHz/div to 1 kHz/div with [SPAN/DIV] [▲] and [SPAN/DIV] [▼] buttons or any value from 100 MHz/div to 1 kHz/div with the keypad or UTIL menu, plus 180 MHz/div in MAX SPAN and 0 Hz/div in ZERO SPAN
Accuracy/Linearity	Within 3%	Measured over the center 8 divisions
Flatness (About the midpoint between two extremes)	±2 dB	Measured with 10 dB of RF Attenuation Flatness is affected by <ul style="list-style-type: none"> <li>■ Input voltage standing-wave ratio (VSWR)</li> <li>■ Gain variation</li> <li>■ Mixer conversion</li> </ul>
<b>Residual FM</b>		
With SPAN/DIV ≤ 20 kHz	≤ 100 Hz peak-to-peak total excursion in 20 ms	Short term, after 1 hr warm-up, and with PHASELOCK in AUTO mode
With SPAN/DIV > 20 kHz	≤ 2 kHz peak-to-peak total excursion in 20 ms	

**NOTE**

*The techniques for reporting the event causing an SRQ are different for RS-232 and GPIB. See the 2714 Programmer Manual.*

**Printing The On-screen Readouts**

The Utility menu also enables you to print the on-screen readouts on an FX-series printer. The 2714 must be equipped with the RS-232 port, and the printer must be connected directly to the port. Each on-screen line is terminated with a linefeed regardless of the terminator selected from the RS-232 configuration menu. Further, the RS-232 port must be on line to use this feature.

Printing the on-screen readouts can be handy if you wish to print results during a user-defined program (UDP) sequence. For instance, suppose that you perform a marker peak find function during the UDP. The frequency and amplitude of the signal are displayed at the upper right of the screen (the normal marker readouts).

To have the 2714 print the readouts through the RS-232 port, ensure your printer is powered up, on line and ready. Place the RS-232 port on line with **[UTIL] [4] [0] [2]**, and press **[UTIL] [9] [0]**. This selects the PRINT READOUTS option under the MORE heading (item 9) of the Utility menu. Printing begins immediately.

---

**SWP/TRIG**

<b>100.0MHz</b>	<b>(AUTO SWEEP)</b>	<b>ATTN 12DB</b>
<b>28.8DBMV</b>		<b>VF 300KHz</b>
<b>1.0MHz/</b>		<b>10 DB/</b>
<b>300KHz RBW (AUTO)</b>		

The Sweep/Trigger menu enables you to select the 2714 trigger mode. During normal operation of the 2714, the sweep generator is free running. A new sweep begins as soon as possible after the end of the previous sweep. However, when dealing with time domain analysis or



Table 2-2: Frequency Related Characteristics (Cont.)

Characteristic	Performance Requirement	Supplemental Information
Resolution Bandwidth (6 dB down)		Resolution bandwidth selections are  5 MHz, 1 MHz, 300 kHz, 100 kHz, 30 kHz, 10 kHz, 3 kHz, 1 kHz, and 300 Hz for the spectrum analyzer
Shape Factor (60 dB/6 dB)	7:1 or less for all resolution bandwidths $\leq 1$ MHz	
Noise Sidebands	$\leq -70$ dBc at 30X Resolution Bandwidth for all resolution bandwidths $\leq 100$ kHz	
Video Filter		Reduces video bandwidth to approximately 1/100 <sup>th</sup> of the selected resolution bandwidth; or one of twelve video filters (3 Hz, 10 Hz, 30 Hz, 100 Hz, 300 Hz, 1 kHz, 3 kHz, 10 kHz, 30 kHz, 100 kHz, 300 kHz, or WIDE) can be selected from the UTIL menu

ment. When a Tektronix service center replaces your battery, it also re-normalizes the references, ensuring that your instrument will operate within its specifications.

If NVRAM is ever lost in the field, you may have to re-normalize the 2714. To begin the process, press **[UTIL] [3] [1]** to carry out a frequency normalization. The 2714 will use default reference values from internal EPROM's or DIP switches. The default values will not result in optimum accuracy, but they will enable you to make approximate measurements. More importantly, they will enable you to carry out the reference normalizations required to ensure that the 2714 is fully within its specification and operating at maximum accuracy.

Follow the instructions in Service Normalizations and the resulting on-screen prompts to perform the service reference normalizations. After the reference normalizations are complete, press **[UTIL] [3] [0]** to complete the frequency and amplitude normalizations.

If external reference sources are not available, simply perform the frequency and amplitude normalizations with **[UTIL] [3] [0]**. The 2714 will be useable, but the references should be renormalized at the earliest opportunity. If the battery is worn out, you will have to re-normalize the 2714 each time it is used until the battery can be replaced.

### Generating a Service Request

***Any control settings can be used***

Utility menu item 6, SERVICE REQUEST, enables you to manually generate a service request (SRQ) whenever required for testing or other purposes. See the 2714 Programmer Manual for detailed information about SRQs and their uses.

To generate a SRQ, press **[UTIL] [6]**. If the communications port is on line, the request is generated immediately and reflected on-screen by the message REQUEST at bottom center (if the port is off line, nothing happens). The message remains on screen until serviced by the controller, or until the communications port is cycled on and off line using **[UTIL] [4] [0] [0] [0]** or **[UTIL] [4] [0] [2] [0]**.

**Table 2-3: Frequency/Amplitude Related Characteristics**

Characteristic	Performance Requirement	Supplemental Information
Marker		<p>The frequency and amplitude values of the marker position are displayed and are preceded by the letter <b>M</b></p> <p><b>[MKR] [ <math>\blacktriangleright</math> ]</b> and <b>[MKR] [ <math>\blacktriangleleft</math> ]</b> position the marker to the next right or left signal peak, respectively</p>
Accuracy		
Frequency		Same as Span/div
Amplitude		A function of the reference level, vertical scale factor, and normalizations (see Display Dynamic Range)
Delta Marker	When activated, a second marker is displayed at the same frequency as the first marker, this is the "Reference Marker"	The <b>FREQ/MARKERS</b> control may be used to position the first marker; the frequency and amplitude differences between markers are readouts preceded by the letter <b>D</b>
Accuracy		
Frequency	1 PPM $\pm$ 10 Hz of the higher marker frequency	With both signals counted
Amplitude		Same as Marker

After you determine the new reference values, complete the process of optimizing the 2714's accuracy by performing a complete normalization by pressing [UTIL] [3] [0].

The remaining items on the Service Normalizations menu are normally used only by service personnel. However, menu item 4 can be used to view selected normalization values, and item 5 sends the normalization values to a printer. These can be handy for future reference. Item 6 sends any messages that occur during normalization to the printer.

If your 2714 has RS-232 installed, you can obtain a hard copy of the normalization values by doing the following.

Place your Epson FX-compatible printer on-line (a plotter will not work unless it can emulate an FX-series printer) with the paper in the correct position, and select item 5 from the Service Normalizations menu. Printing starts immediately. Control of the 2714 is returned following printout.

## If You Lose NVRAM

### NOTE

*If NVRAM is lost, the flatness correction data will also be lost. This data can be reloaded by a Tektronix service center or by using the procedure described in the 2714 Service Manual.*

The NVRAM in the 2714 is powered by lithium batteries. Battery life is limited to a few years (see Table 2-7).

### WARNING

*Handling and disposing of lithium cells can be hazardous. Refer all battery maintenance to a Tektronix service center.*

When the batteries run down, NVRAM and all of its contents are lost. All stored settings, tables, and waveforms disappear, as well as all normalization data. To prevent inadvertent loss of the reference normalizations, routinely return your 2714 to Tektronix for battery replace-

**Table 2-3: Frequency/Amplitude Related Characteristics (Cont.)**

<b>Characteristic</b>	<b>Performance Requirement</b>	<b>Supplemental Information</b>
Center Measure		<p>When activated, the signal nearest center screen (or nearest marker if marker is on) and above a preset threshold level, is moved to center screen</p> <p>The frequency and amplitude values are preceded by the letter C</p>
Readout Resolution	1 kHz or 1 Hz	Readout resolution is selectable
Signal Tracking		<p>When activated, the centered signal is held at center screen</p> <p>Signal tracking requires a signal strength greater than the threshold level</p> <p>If the strength of a signal being tracked decreases below the threshold level, the instrument displays the message NO SIGNAL FOUND ABOVE THRESHOLD</p>

specify the 2714 gain step sizes and the frequency and amplitude of the internal calibrator signal. The references are determined by comparison with an accurate external attenuator and signal source. If NVRAM is ever lost (for instance, because the battery runs down), the factory reference normalizations are lost with it, and you must perform a service reference normalization to achieve maximum accuracy from the 2714. If you have signal sources available that are more precise than the on-board calibration signal, they can be used to achieve added accuracy when normalizing the 2714.

Press [UTIL] [5] [5] to select SERVICE NORMALIZATIONS. Using the REFERENCE NORMALIZATIONS selection from the Service Normalizations menu, you can measure new reference values for the on-board calibration signal and attenuator with respect to more precisely known alternate sources. The alternate sources must exceed the following specifications.

frequency: 5 parts in 10<sup>7</sup>,  $\pm 10$  Hz

amplitude:  $-18.8, \pm 0.1$  dBmV @ 100,  $\pm 1$  MHz

attenuation (gain step):  $\pm 10$  0.5 dB @ 100,  $\pm 1$  MHz

We will not give examples for all reference normalizations, but we will show you how to determine a new frequency reference.

Connect an external frequency source to the 2714 input meeting the frequency specification given above. Various sources are available (for example, WWV in the U.S., some broadcast television carriers, assorted frequency standards. A frequency of 100 to 500 MHz would be very good, but signals as low as 5 MHz can be used.

Return to the spectral display and perform a center measure to ensure the external reference is centered. Then select item 1, REFERENCE NORMALIZATIONS, from the Service Normalizations menu. Next select item 1, INTERNAL REF FREQ, from the resulting Reference Normalizations menu. On-screen prompts appear for each of the reference normalizations. Select item 1 and enter the frequency of the external source. Now select item 2 and press [W] when you are ready to have the 2714 determine the new reference. After a few seconds you will receive a NORMALIZATION COMPLETE message.

Determining new gain step and amplitude references is done in a similar fashion (follow the prompts).

**Table 2-4: Amplitude Related Characteristics**

<b>Characteristic</b>	<b>Performance Requirement</b>	<b>Supplemental Information</b>
Vertical Display Mode		10 dB/div, 5 dB/div, 1 dB/div, and Linear
Reference Level		
Range		Top of graticule
Log Mode		-21.2 dBmV to +68.8 dBmV (-41.2 dBmV to +48.8 dBmV with the PREAMP enabled)
Linear Mode		10.83 $\mu$ V/div to 342.33 mV/div (1.08 nV/div to 34.23 mV/div with the PREAMP enabled)
Steps		
Log Mode		1 dB or 10 dB
Linear Mode		1-2-5 sequence: 10.83 $\mu$ V/div to 342.33 mV/div
FINE REF LVL STEP On		$\geq 0.2$ division per increment
Accuracy		Dependent on <ul style="list-style-type: none"> <li>■ Normalizations</li> <li>■ Calibrator accuracy</li> <li>■ Frequency response</li> </ul>

## Diagnostics and Adjustments

<i>Any control settings can be used</i>
---

Many of the items on the Utility menu are intended for servicing of the 2714. However, we will describe a few used to verify instrument performance. Items not discussed are reserved for service personnel or for use under factory supervision.

Call up the Utility menu and select item 5, INSTR DIAGNOSTICS/ADJUSTMENTS.

### Aligning the Display

#### NOTE

*This procedure will overwrite saved waveforms without warning.*

To align the display, select MANUAL ADJUSTMENTS from the [UTIL] menu, and then select DISPLAY STORAGE CAL from the resulting Manual Adjustments menu by pressing [UTIL] [5] [2] [2].

This selection creates a checkerboard display used to adjust trace position and rotation. The trace rotation, vertical, and horizontal alignment controls are located on the back of the 2714 (see Miscellaneous Controls in Section 5).

Turn the **TRACE ROT** control until the checkerboard test pattern is rotationally aligned with the graticule. Adjust the **VERT POS** control until the the top line of the pattern coincides with the top graticule line. Last, turn the **HORIZ POS** control until the vertical center line of the display coincides with the center vertical line of the graticule.

After completing the alignment, repeatedly press [UTIL] until the spectral display reappears.

### Service Normalizations

The 2714 contains a set of frequency and amplitude normalization values when it is shipped from the factory. The normalizations are based on reference values, called reference normalizations, determined at the time of manufacture. The reference normalizations



Table 2-4: Amplitude Related Characteristics (Cont.)

Characteristic	Performance Requirement	Supplemental Information																				
Display Dynamic Range	80 dB maximum (Log) 8 divisions (Lin)	Log Mode Display Dynamic Range is dependent upon the selected Resolution Bandwidth																				
<b>Accuracy</b>																						
10 dB/div Mode	$\pm 1.0$ dB/10 dB to a maximum cumulative error of $\pm 2.0$ dB over the 70 dB range and a maximum cumulative error of $\pm 4.0$ dB over the 80 dB range	10 dB/div accuracy and range is affected by the signal-to-noise ratio of the selected Resolution Bandwidth filter. See following table for maximum specified range.																				
		<table border="1"> <thead> <tr> <th>Resolution Bandwidth</th> <th>dB Down</th> </tr> </thead> <tbody> <tr> <td>5 MHz</td> <td>40</td> </tr> <tr> <td>1 MHz</td> <td>40</td> </tr> <tr> <td>300 kHz</td> <td>50</td> </tr> <tr> <td>100 kHz</td> <td>50</td> </tr> <tr> <td>30 kHz</td> <td>60</td> </tr> <tr> <td>10 kHz</td> <td>60</td> </tr> <tr> <td>3 kHz</td> <td>80</td> </tr> <tr> <td>1 kHz</td> <td>80</td> </tr> <tr> <td>300 Hz</td> <td>80</td> </tr> </tbody> </table>	Resolution Bandwidth	dB Down	5 MHz	40	1 MHz	40	300 kHz	50	100 kHz	50	30 kHz	60	10 kHz	60	3 kHz	80	1 kHz	80	300 Hz	80
Resolution Bandwidth	dB Down																					
5 MHz	40																					
1 MHz	40																					
300 kHz	50																					
100 kHz	50																					
30 kHz	60																					
10 kHz	60																					
3 kHz	80																					
1 kHz	80																					
300 Hz	80																					
5 dB/div Mode	$\pm 1.0$ dB/10 dB to a maximum cumulative error of $\pm 2.0$ dB over the 40 dB range																					
1 dB/div Mode	$\pm 1$ dB maximum error over the 8 dB range																					
Linear Mode	$\pm 5\%$ of full scale																					
RF Attenuator Range		0 to 50 dB in 2 dB steps																				

However, to protect an individual file in the file system, first determine its file number by viewing the file directory by pressing [UTIL] [4] [6]. The number is listed under the FID column in the directory. Return to the System Configuration menu and select item 7, PROTECT FILE. Following the on-screen prompt, enter the number of the file you want to protect. Confirm your selection by pressing [W]. It is now impossible to delete the file without first unprotecting it.

Repeat the foregoing process to unprotect a previously protected file. The process constitutes a toggle that alternately protects and unprotects the designated file.

### NOTE

*Unless you have specific reasons for doing otherwise, do not protect system parameter and normalization files (see Table 6-5). Doing so may prevent the 2714 from carrying out its normal functions or updating data.*

## Confirming Installed Options

If you are in doubt as to which options are installed in your instrument, press [UTIL] [4].

Item 9 on the resulting System Configuration menu is labeled INSTALLED OPTIONS DISPLAY. Select item 9. The resulting display begins by listing the instrument's firmware version and the Tektronix copywrite. Below that, two columns list the options installed in your 2714. You will see a readout similar to the following.

```
NVM 1 12.88      NVM 2 12.88
RS-232
```

The number following NVM (non-volatile memory) is for internal Tektronix use only and of no value to the user. The list will vary according to the options actually installed in your instrument.

**Table 2-4: Amplitude Related Characteristics (Cont.)**

Characteristic	Performance Requirement	Supplemental Information
Sensitivity without Preamp		Equivalent maximum input noise for each resolution bandwidth
Resolution Bandwidth	<b>@100 MHz @ 1.8 GHz</b>	
5 MHz	-36 dBmV -28 dBmV	Sensitivity decreases linearly approximately 8 dB from the low end to the high end of the frequency range
1 MHz	-43 dBmV -35 dBmV	
300 kHz	-48 dBmV -40 dBmV	
100 kHz	-53 dBmV -45 dBmV	
30 kHz	-58 dBmV -50 dBmV	
10 kHz	-63 dBmV -55 dBmV	
3 kHz	-68 dBmV -60 dBmV	
1 kHz	-73 dBmV -65 dBmV	
300 Hz	-78 dBmV -70 dBmV	
<b>Sensitivity with Preamp</b>		<b>NOTE</b>
Resolution Bandwidth	<b>@100 MHz</b>	<i>Sensitivity with the Preamp enabled is not specified above 600 MHz.</i>
5 MHz	-48 dBmV	
1 MHz	-55 dBmV	
300 kHz	-60 dBmV	
100 kHz	-65 dBmV	
30 kHz	-70 dBmV	
10 kHz	-75 dBmV	
3 kHz	-80 dBmV	
1 kHz	-85 dBmV	
300 Hz	-90 dBmV	

Table 7-3: The File System (Cont.)

Channel Tables	CATV Measurement Results	Flatness Corrections	Normalizations
CHTBLO – CHTBL9	RSLTX	FCOR	NORM

Table 7-4: Additional File System

Name	Description
12.88	Version
SEARCH	Signal search configuration
SETUP	Instrument configuration
S_CATV	CATV configuration
S_GPIB	GPIB configuration
S_PLOT	Plotter configuration
S_RTC	Real-time clock configuration
S_TTYx	RS-232 configuration

DSET00 and SET0BU are special files. They are created automatically by the 2714 and contain the D-register settings used when the 2714 was last turned off. SET0BU is a backup in case DSET00 is corrupted during a power-down or power-up cycle.

Other temporary files may also be created by the 2714 for internal purposes.

## Protecting Files

Files you wish to preserve such as waveform, settings, or UDP files can be protected from accidental erasure in several ways. UDP files can be selectively protected from the USERDEF menu, while all settings files can be protected by pressing **[UTIL] [4] [5]**.

Table 2-4: Amplitude Related Characteristics (Cont.)

Characteristic	Performance Requirement	Supplemental Information
Spurious Responses		
Residual (no input signal)	$\leq -51$ dBmV ( $\leq -100$ dBm) except at 1780 MHz where the spurious response is $\leq -41$ dBmV ( $\leq -90$ dBm)	With 0 dB RF attenua- tion
3 <sup>rd</sup> Order IM Products	$\leq -70$ dBc	From any two on-screen signals within any fre- quency span
Zero Frequency Spur	$\leq +39$ dBmV ( $\leq -10$ dBm)	Referenced to input with 0 dB RF attenuation
2 <sup>nd</sup> Harmonic Distortion	$\leq -66$ dBc	Measured with 1 <sup>st</sup> mixer input level of $\leq +9$ dBmV
LO (Local Oscillator) Emission	$\leq -21$ dBmV ( $\leq -70$ dBm)	With 0 dB RF attenua- tion

## The Menus

Press [UTIL] [4] [6] to view a directory of existing file names.

File names are established by the firmware. Table 7-3 and Table 7-4 list the file names and describe their contents. Files are created only as required. That is, you will not find a BSET03 settings file unless you have previously saved the B-register settings in the third storage location.

Several other files representing system parameters may also be present, including the following:

**Table 7-3: The File System**

---

**Settings Files:** Each file saves the control settings for a particular register (A, B, C, D) in a designated location (00–39). BSET03 saves B-register settings in the number 3 location.

---

**Curve Files:** Each file saves curve data from register A, B, or C in a designated location (00–39). D-register curves are never saved. AWFMO4 saves the A-register curve in location 4.

---

**User-Defined Program (UDP) Files:** Each file saves a keystroke sequence representing a particular UDP in a designated location (0–8). UDP1 is the second user-defined program.

---

**Channel Table Files:** Each file saves the channel table in a designated location (0–9) representing channel table data for a particular table. CHTBL3 saves the channel table information in location 3.

---

**CATV Measurement Results Files:** Each file saves the CATV measurement results in a designated location (1–4). RSLT3 saves the CATV measurement results in the number 3 location.

---

**Flatness Correction Data Files:** Flatness files save the data generated by running the flatness correction procedure.

---

**Antenna Table Files:** Each file saves the antenna table in a designated location (1–5) representing antenna data for a particular antenna. ACF3 saves the antenna information in location 3.

---

**Normalization File:** Normalization files save the data generated by normalizing the Spectrum Analyzer, including reference normalization.

---

**File Names**

---

<b>Curves n=A,B,C</b>	<b>Settings n=A,B,C,D</b>	<b>User-Defined Programs</b>	<b>Antenna Tables</b>
nWFM00 – nWFM39	nSET00 – nSET39	UDP0 – UDP8	ACF1 – ACF5

---

Table 2-5: Input/Output Signal Characteristics

Characteristic	Performance Requirement	Supplemental Information
RF Input		Type F male connector
VSWR with RF Attenuation $\geq 10$ dB	1.5:1 maximum	Checked to 1 GHz
VSWR with 0 dB RF Attenuation	2:1 max up to 1 GHz 3.5:1 max up to 1.8 GHz	
Maximum Safe Input		+70 dBmV (0.1 W or 2.2 V) continuous peak 100 VDC blocking capacitor <b><i>Do not apply more than 100 VDC to the RF Input</i></b>
1 dB Compression Point (minimum)	+34 dBmV (-15 dBm)	With no RF Attenuation and 1 <sup>st</sup> mixer at +19 dBmV
Ext Trig (J102)		BNC connector, 10 k $\Omega$ , DC coupled for external trigger signals
Voltage Range		
Minimum		Typically at least 100 mV <sub>peak</sub> , 15 Hz to 1 MHz
Maximum		50 V (DC + peak AC)
Pulse Width		0.1 $\mu$ s minimum

Ensure the spectral display is turned on in the menus and select item 7, SWEEP HOLDOFF, from the Instrument Configuration menu. Messages appear to indicate which features are sacrificed when using short holdoff. Read the messages, and then press **[W]** to continue. The SWEEP HOLDOFF status switches from NORMAL to SHORT HOLDOFF and a signal peak may appear at the left edge of the screen.

Reset the sweep holdoff to NORMAL and turn off the SPECTRAL DISPLAY IN MENU.

## Setting the Date and Time

The 2714 contains a real-time clock with battery backup power. The clock is used primarily to display the date and time stamp on measurement results. The clock is also used to trigger user-defined programs and to label printer/plotter outputs.

To set the real-time clock, return to the System Configuration menu by pressing **[UTIL] [4]** and select item 4, REAL-TIME CLOCK SETUP. Select items 0 through 5 to update the clock. Terminate each entry by pressing **[W]**. Select item 6 to toggle the clock display on or off in the menu, the spectral display, and printer/plotter outputs. Press **[UTIL]** to return to the spectral display.

## Protecting Stored Settings

Call up the System Configuration menu by pressing **[UTIL]**. Toggle item 5, STORED SETTINGS PROTECT, to ensure the end-of-line status indicator is set to ON.

Press **[BKSP]** to return to the Utility menu, and select STORED SETTINGS/DISPLAYS. Attempt to delete any stored setting. The message ONLY WAVEFORMS DELETED appears.

When STORED SETTINGS PROTECT is turned on, you cannot delete the stored settings, but waveforms stored along with them will be deleted.

Turn STORED SETTINGS PROTECT off.

## The File System

The 2714 stores settings, waveforms and other data in a system of files in NVRAM. Normally you will not alter those files.



Table 2-5: Input/Output Signal Characteristics (Cont.)

Characteristic	Performance Requirement	Supplemental Information
Accessory Connector (J103)		DB-9 female connector
Pin 1 External Video Input		<p>Typically 100 <math>\Omega</math>, DC coupled, 0–50 kHz, 0–1.6 V (200 mV/div) signal input for vertical deflection of the CRT beam</p> <p>The signal is processed through the video filters and the 1 dB, 5 dB, and 10 dB scale factor circuits on the Log board</p> <p>Display storage may be bypassed</p>
Pin 2 Chassis and Signal Ground		
Pin 3 Video Output		<p>Provides 0 V to +1.6 V of video signal, inversely proportional to the vertical display amplitude</p> <p>0 V is the top of the screen</p> <p>Impedance is 1 k<math>\Omega</math></p>
Pin 6 Sweep Gate		TTL-compatible signal that goes to logic high level while the CRT beam is sweeping
Pin 7 Sweep Output		Provides a nominal +1.3 V to –1.3 V negative-going ramp, proportional to the horizontal sweep (output impedance $\leq$ 50 $\Omega$ )
Pins 4, 5, 8, and 9		Reserved for future options

### **NOTE**

*Short Holdoff mode reduces the inter-sweep interval even further, but also disables most marker measurement modes.*

Observe the spectral display for a few sweeps. There is a slight pause about every fourth sweep. This is the period during which the corrections are computed and implemented.

Reduce the span to 50.0 kHz/div. Watch the signal peak for several minutes and notice how it drifts relative to screen center and then is recentered as the 2714 computes and implements the corrections.

Item 5, FREQUENCY CORRECTIONS, from the Instrument Configuration menu is a toggle that enables you to turn the corrections off and on. Press [5] to turn off the corrections, and then return to the spectral display. Notice how the signal now drifts continuously. Press [5] again to turn the frequency corrections back on. Return to the spectral display, and note that the signal is again centered.

## **The Spectral Display In Menus**

Press [UTIL] [4] [3] to activate the Instrument Configuration menu. Repeatedly select item 6, SPECTRAL DISPLAY IN MENUS, and note how the spectral display is superimposed on the menu. Some people prefer to have the display present when working with menus, others do not. For now, leave the display turned on.

## **Changing the Sweep Holdoff**

There is a holdoff period between the end of one sweep and the start of the next to give the internal circuits time to stabilize. For faster response time when continuous observation of signals is necessary, the delay can be minimized by entering the short holdoff mode. When using short holdoff in the AUTO sweep mode, a fictitious signal sometimes appears at the left edge of the screen.

### **NOTE**

*Turning on SHORT HOLDOFF disables frequency corrections and most marker measurement modes.*

**Table 2-5: Input/Output Signal Characteristics**

Characteristic	Performance Requirement	Supplemental Information
Digital Communications Port (J104)		24-pin connector if Option 03 (GPIB) is installed  9-pin connector if Option 08 (RS-232) is installed  (If no option is specified at time of purchase, a 9-pin connector, conforming to RS-232-C, is provided)

**Table 2-6: Power Requirements**

Characteristic	Performance Requirement	Supplemental Information
<b>Input Voltage</b>		
Line Voltage Range	90 VAC to 250 VAC	Type F male connector
Line Frequency Range	48 Hz to 63 Hz	
Line Voltage Range	90 VAC to 132 VAC	
Line Frequency Range	48 Hz to 440 Hz	
Line Fuse	2 A Slow-Blow	
Input Power	90 W (1.2 A) for standard instrument  105 W (1.4 A) maximum with options  (115 W maximum at 90 V and 440 Hz)	At 115 V and 60 Hz
Leakage Current		3.5 mA <sub>RMS</sub> maximum or 5 mA <sub>peak</sub> maximum

Item 2 toggles data transmission ON and OFF, and item 3 toggles the data format between ASCII and binary.

### Turning PhaseLock On and Off

<b>100.0000MHz</b>	<b>(AUTO SWEEP)</b>	<b>ATTN 12DB</b>
<b>28.8DBMV</b>		<b>VF 3KHz</b>
<b>20.0KHz/</b>		<b>10 DB/</b>
<b>3KHz RBW (AUTO)</b>		<b>CALIBRATOR</b>

The 2714 uses internal reference oscillators to analyze the input signal. At wide spans, a slight amount of drift in an internal oscillator is not noticeable. However, as the span is reduced to a few kHz/div or less, any internal oscillator jitter becomes apparent. The on-screen indication is phase noise close to the base of a signal and/or an apparently drifting signal. Therefore, the oscillators in the 2714 are typically phaselocked to a stable reference when operating at narrow spans. This happens automatically when the span is 20 kHz/div or less. Phaselock minimizes the amplitude of the noise pedestal close to a signal, but may actually increase it slightly at frequencies farther away. Therefore, phaselock may be turned off when desired.

Toggle phaselock between AUTO and OFF using item 4, PHASE-LOCK, from the Instrument Configuration menu. Return to the spectral display to see the effects. Leave PHASELOCK in AUTO when you are done.

### Frequency Corrections On and Off

<b>300.0MHz</b>	<b>(AUTO SWEEP)</b>	<b>ATTN 12DB</b>
<b>28.8DBMV</b>		<b>VF WIDE</b>
<b>50.0MHz/</b>		<b>10 DB/</b>
<b>5MHz RBW (AUTO)</b>		<b>CALIBRATOR</b>

During normal operation, the 2714 periodically computes frequency corrections (to compensate for short-term drift within the 2714 itself) and applies them to the displayed trace. It does this between sweeps. You can shorten the inter-sweep interval by disabling the frequency corrections, although some high-frequency accuracy may be sacrificed, and the signal may drift off screen at small spans/div.

Table 2-7: Supplementary Characteristics Due to Options

Characteristic	Performance Requirement	Supplemental Information
Option 03		Provides a GPIB interface port at J104 (24-pin connector that conforms to IEEE Std 488.1–1978)
Option 08		Provides a RS-232 serial interface port at J104 (9-pin connector)
Option 15		
1 <sup>st</sup> LO Output Level	$\geq +48.8$ dBmV ( $\geq 0$ dBm)	Add a 1 <sup>st</sup> LO output

Table 2-8: General Characteristics

Characteristic	Performance Requirement	Supplemental Information
Sweep		Normal, Single Sweep, and Manual Scan
Sweep Rate	1 $\mu$ s/div to 2 s/div in a 1–2–5 sequence	
Accuracy	$\pm 10\%$ over the center 8 divisions	
Triggering		Free Run, Internal, External, Line, TV Line, and TV Field
Internal Trigger Level	1 division or more of signal	
External Trigger Level		See EXT TRIG in Table 2-5

OFF — The 2714 creates no audible beeps.

KEYCLICK ONLY — The 2714 emits a short beep when a key is pressed.

ERROR ONLY — This is the factory default. A beep occurs only when the 2714 issues an alarm, error, or warning message. The alert sounds only once, even if the condition repeats and a displayed message is repeated.

KEYCLICK & ERROR — Combination of KEYCLICK ONLY and ERROR ONLY modes.

Switch the audio alert to the setting of your choice.

### Setting the Minimum Signal Size

Minimum signal size is the smallest amplitude difference that must exist between signal peaks for them to be recognized as separate peaks during Next Higher and Next Lower or Marker arrow operations. It is expressed in bits; full scale being 255 bits. The minimum value is 2 bits; factory default is 20 bits or approximately 8% of full scale (three minor divisions).

Select item 1, MINIMUM SIGNAL SIZE, from the Instrument Configuration menu. Type a new value and enter it by pressing [W]. The new value appears at the end of item 1. Experiment if you wish, then restore the factory default value.

### Sending Waveforms To a Computer

#### NOTE

*This feature is used primarily for certain procedures at the factory; we recommend that you leave WAVEFORM TO PRINTER turned off.*

Item 2 of the INSTRUMENT CONFIGURATION menu, WAVEFORM TO PRINTER with [UTIL] [4] [3] [2], sends a binary or ASCII representation of the displayed waveform to the serial port following each sweep. The 2714 must have the RS-232 port installed, and PRINTER CONFIGURATION with [UTIL] [4] [2] [0] must be set to TTY00.

Table 2-8: General Characteristics (Cont.)

Characteristic	Performance Requirement	Supplemental Information
Non-Volatile Memory (Battery-Backed Up)		Instrument settings, waveforms, and normalization results are stored in NVRAM
Battery Life (Lithium)		
At +55° C Ambient Temperature		1 to 2 years
At +25° C Ambient Temperature		At least 5 years
Temperature Range for Retaining Data		-10° C to +75° C
Internal Calibrator		Provides 100 MHz marker for amplitude calibration and comb of 100 MHz markers for frequency and span calibration
Amplitude and Accuracy	+18.8 dBmV (-30 dBm), $\pm 0.3$ dB, at 100 MHz, $\pm 2$ kHz	
Drift	$\pm 2$ PPM/Year	

If you set item 1 to a plotter, plot speed and number of plots per page options appear on the Screen Plot Configuration menu. Repeatedly select item 2, PLOT SPEED, to cycle through the available speeds of FAST, FASTER, FASTEST, SLOW, and NORMAL (the default). Try the various speeds with your plotter to see which produces the most satisfactory results. Printers do not support these options.

If you select 4 plots per page, a plot position option appears that enables you to select the quadrant of the paper on which the current plot will be placed. Repeatedly select item 4, PLOT POSITION, to cycle through the available positions.

Item 5 on the SCREEN PLOT CONFIGURATION menu determines whether or not graticule lines are printed on the hard copy output. Status of the plotted graticule lines is independent of whether the on-screen graticule illumination is on or off. Press [5] to toggle the GRATICULE LINES ON PLOT between ON and OFF.

### Selecting the Printer Configuration

All CATV measurements enable you to send ASCII character strings to the CRT or to the optional RS-232 port. You cannot send these strings to a GPIB device.

Return to the SYSTEM CONFIGURATION menu by pressing [UTIL] [4] and select item 2, PRINTER CONFIGURATION. Then select item 0, PRINTER DEVICE.

If the RS-232 interface is installed, the PRINTER DEVICE will toggle between TTY00 and CRT. If the GPIB option is installed, CRT is always displayed. Select CRT if you want results that would normally be sent to a printer to be displayed on the 2714 screen instead. On-screen display is sometimes not satisfactory if there is more than one screen of data, because only the last screen remains visible.

### Instrument Configuration

Item 3, INSTRUMENT CONFIGURATION, of the System Configuration menu enables you to reset internal parameters and conditions. Some of the more useful ones are described in the following subsections.

The Audio Alert — Item 0, AUDIO ALERT, of the Instrument Configuration menu is a four-step sequencer whose status is indicated at the end of the line. You can choose OFF, KEYCLICK ONLY, ERROR ONLY, or KEYCLICK & ERROR.



Table 2-9: Environmental Characteristics

Characteristic	Description
<i>The Description column describes how most characteristics were derived and a description of the characteristic. This instrument meets MIL-T-28800E, Type III, Class 5, Style C Specifications.</i>	
Temperature	
Operating and Humidity	0° C to +50° C MIL-T-28800E 5 cycles (120 hours)
Non-operating <sup>1</sup>	-55° C <sup>2</sup> to +75° C
Altitude	
Operating	4.57 km (15,000 ft)
Non-operating <sup>1</sup>	15.24 km (50,000 ft)
Humidity (Non-operating)	Five cycles (120 hours) in accordance with MIL-STD-28800E, class 5
Vibration	
Operating (Instrument secured to a vibration platform during test)	MIL-T-28800E, Method 514 Procedure X (modified) 15 minutes along each of 3 major axes at a total displacement of 0.38 mm (0.015 inch) peak-to-peak (2.4 g at 55 Hz), with frequency varied from 10 Hz to 55 Hz in 1-minute sweeps  Hold for 10 minutes at 55 Hz  All major resonances must be above 55 Hz
Shock Operating and Non-operating	Three guillotine-type shocks of 30 g, one-half sine, 11 ms duration each direction along each major axis; total of 18 shocks
Transit Drop (free fall)	203.2 mm (8 inch), one per each of 6 faces and 8 corners (instrument is tested and meets drop height of 304.8 mm (12 inches).

- 1 After storage at temperatures below -15° C, the instrument may not reset when power is first turned on. If this happens, allow the instrument to warm up for at least 15 minutes, then turn POWER OFF for 5 seconds and back ON.
- 2 NVRAM is lost below -10° C.

- The ASCII codes for carriage return (CR) and line feed (LF) are appended to the message; EOI is still asserted simultaneously with the transmission of LF

All Tektronix instruments and controllers use EOI to terminate messages. You should, therefore, toggle item 3 until the end of the line indicates EOI. The EOI/LF MODE option is included for controllers that do not use the EOI signal line.

Item 4, TALK ONLY MODE, must be set to OFF when the 2714 is used with a controller, because the controller determines whether the 2714 is talking or listening. If you normally use the 2714 with a controller, set the TALK ONLY MODE to OFF.

However, to send screen plot data directly to a GPIB plotter without a controller, set the TALK ONLY MODE to ON, and disconnect all instruments except the 2714 and the plotter from the bus. Place the plotter in the listen only mode (usually done with controls on the plotter). You can then send screen data from the 2714 to the plotter by pressing **[PLOT]**.

### Selecting the Screen Plotter Configuration

Whichever communications port is installed in your 2714, the spectral display and its attendant information can be sent to a printer or plotter by pressing **[PLOT]**, but you must first correctly configure the interface.

To configure the port in your 2714 for use with your particular printer or plotter, select item 1 of the System Configuration menu, SCREEN PLOT CONFIGURATION.

Item 0, COMM PORT, on the Screen Plot Configuration menu simply indicates which communications port is installed in your instrument. No operator action is needed. However, your print/plot device must also be equipped with a corresponding interface (GPIB or RS-232).

Item 1, PLOTTER LANGUAGE, cycles through the printer and plotter models supported by the 2714. Repeatedly select item 1 from the menu. Each time you press **[1]**, the printer or plotter displayed at the end of the line changes. EPSON FX (the default) refers to FX-series printers produced by Epson, and HPGL stands for Hewlett Packard Graphics Language. Stop when the model of your printer/plotter (or the one yours emulates) is displayed.

**Table 2-9: Environmental Characteristics (Cont.)**

<b>Characteristic</b>	<b>Description</b>
Electromagnetic Interference (EMI)	
Radiated and Conducted Emission	
FCC	FCC Part 15, sub-part J, Class A
VDE	VDE 0871, Class B

**Table 2-10: Physical Characteristics**

<b>Characteristic</b>	<b>Performance Requirement</b>
Weight	
With Standard Accessories	11.34 kg (25 lbs)
Without Standard Accessories	10.21 kg (22.5 lbs)
Dimensions	
Height with Feet and Handle	137.16 mm (5.4 inches)
Width	
With Handle	360.68 mm (14.2 inches)
Without Handle	327.66 mm (12.9 inches)
Depth	
With Front Panel Cover	444.50 mm (17.5 inches)
Without Front Panel Cover	427.99 mm (16.85 inches)
With Handle Extended	510.54 mm (20.1 inches)

Item 6, ECHO, is a toggle intended for use with unsophisticated terminals. When ECHO is ON, the 2714 sends the character it has just received back to the terminal screen. CTRL Q and CTRL S are not echoed. The default is OFF.

Item 7, VERBOSE, is another on/off toggle. When VERBOSE is ON, a response is returned to the controller following each command or query. The response may be an event code, the correct query response, or a simple OK for a completed command not normally requiring a response. When VERBOSE is OFF, only responses to queries are generated. The default is OFF

**GPIB Configuration** — To configure the 2714 for GPIB operation, select item 0, GPIB, on the COMMUNICATION PORT CONFIG menu. The GPIB Port Configuration menu appears.

Item 0, STATUS, enables you to toggle the GPIB port on and off line. The port must be on line to communicate with any other device.

Item 1, GPIB ADDRESS, specifies the primary address (the 2714 does not support secondary addresses), that can be any value from 0 to 30. When the 2714 is used with a system controller, the value must match that used to configure the controller. Address 0 is usually reserved for the controller itself. When the 2714 is used in the TALK ONLY mode with a plotter, any address can be used. The address you set is read immediately by the 2714 and retained in NVRAM until you change it.

Item 2, POWER ON SRQ, determines whether a service request (SRQ) is generated at power up. Because there normally is no need for a SRQ at power up, the default setting of item 2, POWER ON SRQ, is OFF. However, in some cases you may want to sense that power has been turned on before continuing your test. For those cases you can toggle the POWER ON SRQ to ON by pressing [2].

Item 3, EOI/LF MODE, sets the end-of-message designator. When a message is transmitted over the GPIB, the instrument sending the message signifies to other instruments on the bus (including the system controller) that the message has been completed. This can be done in two ways.

- The interface management line named End Or Identify (EOI) is asserted (brought to its low state) simultaneously with the last data byte that is transmitted



# **Getting Acquainted With Your Instrument**

## The Menus

Item 1, BAUD RATE, cycles through the baud rate of the port. Possible baud rates are:

110	600	4800
150	1200	9600
300	2400	

Normally, you set this parameter to as large a value as possible to speed up data transfer. However, the controller, or the printer/plotter, must support data transfers at the same rate. When 110 is chosen, two stop bits are automatically selected; for any other value, 1 stop bit is automatically selected. The default value is 9600.

Item 2, DATA BITS, determines the number of data bits per word. The default is 8 bits and is required for binary data transfers. Seven bits can be used for ASCII character transfers.

Item 3, PARITY, cycles between NONE, ODD, and EVEN. The default is NONE.

Item 4, EOL, sets the end-of-message designator when a message is sent by the 2714. When a message is transmitted over RS-232, the instrument sending the message signifies that the message has been completed. Item 4 enables you to select CR (carriage return), LF (line feed), or CR LF (both) used to terminate messages sent to the 2714. The default is CR.

Item 5, FLOW CONTROL, specifies the type of handshaking that will be used. The following three choices are possible (see the Programmer manual for expanded information on these selections).

**HARD (RTS/CTS)** — The RTS, CTS, DTR lines are used. The DCD and DSR lines are ignored. This mode facilitates binary transfers.

**SOFT (XON/XOFF)** — XON/XOFF (CTRL Q/CTRL S) protocol is used. Only transmit and receive lines are needed, but RTS and DTR must be forced true. Suitable for use with a modem. However, code conflicts make binary transfers unreliable.

**NONE** — No flow control is used, but RTS and DTR must be forced true. This is suitable for use with a modem. However, the user is responsible to ensure that data buffers do not overflow.

The default is NONE.



## Configuring the Communications Port

The 2714 is provided with a digital communications port to enable it to exchange data and commands with an external instrument controller, or a printer/plotter. Either an RS-232 Interface (Option 08) or an IEEE 488 General Purpose Interface Bus (GPIB) port (Option 03) is available. The RS-232 port is modem-compatible and makes possible the remote operation via telephone line. Port connectors are located on the rear panel. See Section 8.

The accompanying Programmer Manual contains additional information about setting up and configuring the 2714 for remote or automated operations and complete explanations of the commands that are used. See the Programmer Manual for additional information on all topics and selections in this Communications Port discussion.

Select item 0 from the System Configuration menu. The COMMUNICATION PORT CONFIG menu appears.

If the RS-232 Interface port is installed, the menu shows the following.

2 RS-232 OFF LINE/BAUD RATE

If the port is currently active, its baud rate is displayed at the end of the line (for example, 9600). Otherwise, the line ends with OFF LINE.

If the GPIB port is installed, the menu shows the following.

0 GPIB OFF LINE/ADDR #

If the port is currently active, its GPIB address (0 through 30) is displayed at the end of the line. Otherwise, the line ends with OFF LINE.

**RS-232 Configuration** — To configure the 2714 for RS-232 operation, select item 2, RS-232, on the COMMUNICATION PORT CONFIG menu. The RS-232 Port Configuration menu appears. Several choices are offered; in all cases the 2714 settings must match those used by the controller or printer/plotter.

Item 0, STATUS, enables you to toggle the RS-232 port on and off line. The port must be on-line to communicate with any other device.





# Getting Acquainted With Your Instrument

This section describes the procedure you should follow when your new 2714 arrives from the factory. Observe the indicated precautions to prevent damage to the instrument during initial check out and subsequent use.

---

## Receiving and Unpacking

The spectrum analyzer and its standard accessories are carefully packed at the factory using a specially designed shipping container to prevent damage during transit.

If, upon receipt, damage to the shipping container is evident, notify the shipper. Tektronix Inc. is not responsible for damage caused during shipping.

If you have not already done so, carefully remove the spectrum analyzer and its accessories from the shipping container and inspect them for damage. Do not destroy the shipping container. Test spectrum analyzer operation using the System Checkout procedure later in this section. If damage or defects are discovered, or if components are missing, notify your local Tektronix field office or representative.

---

## Packaging and Storing

In the event that the equipment must be returned to a Tektronix Service Center, carefully package it in the original shipping container. Use the vinyl vapor barrier, and insert the original foam blocks in the same fashion they were received. If the original shipping materials are not available, use a container of equivalent strength and dimensions. Wrap the instrument in a vinyl vapor barrier, and cushion the instrument on all sides with foam or other suitable packing material.

PRESS "W" TO CONTINUE

PRESS "Z" TO ABORT

If you have facilities to carry out the reference normalizations (see Service Normalizations later in this section), abort this process and perform the reference normalizations before continuing. Otherwise, press **[W]** to continue. A recently normalized instrument is more accurate than an un-normalized one, even if the references have not been normalized.

The normalization process completes without further operator intervention. When it is complete, a beep sounds if the audio alert is enabled (see The Audio Alert later in this section) and the following message appears.

NORMALIZATION COMPLETE

If you receive a message that either frequency or amplitude normalization failed, try the procedure again. The spectral display reappears automatically upon completion of normalization. In case of repeated failures, contact your local Tektronix Service Center or representative.

### **System Configuration**

All configuration settings selected in the UTIL menu are retained in NVRAM until you change them. Call up the Utility menu and select item 4, SYSTEM CONFIGURATION. The System Configuration menu offers nine choices.

## Getting Acquainted With Your Instrument

Attach a tag to the instrument clearly showing.

- Owner's name and address
- Name of the person at your location who may be contacted
- Instrument model and serial number
- Description of the problem and service expected

The spectrum analyzer can be stored up to 90 days in an environment that meets the non-operating specifications. It is suggested that you provide a dust cover. For longer periods, the instrument should be enclosed in a vapor barrier containing appropriate desiccant material and stored in an environment that meets the non-operating specifications. The original shipping material can be used and is also useful for protecting the equipment if it must be moved.

---

## Installation

The 2714 is designed for table-top operation in any orientation and requires no special installation. However, the handle can be positioned at several angles to serve as a convenient tilt stand. To position the handle, pull out at both pivot points on the sides of the instrument, and simultaneously rotate the handle to the desired position.

Tektronix Inc. also provides an optional rackmount adapter kit (Option 30) that requires 133.35 mm (5.25 in.) vertical clearance and a cradle mount adapter (Option 34) that requires 177.80 mm (7 in.). Contact your local Tektronix field office or representative for additional information.

The 2714 is equipped with a plastic front panel cover to protect it from mechanical damage. The cover should always be used when transporting the spectrum analyzer. To remove the cover, place the instrument on its back feet, and then simultaneously pull out and up slightly on each side of the cover.

Regardless of where the spectrum analyzer is used or installed, always provide at least two inches 50.80 mm (2 in.) clearance adjacent to the cooling vents at the sides, bottom, and back of the spectrum analyzer.

See Section 2, *Specifications*, for input power requirements.

- Large temperature difference from that at which previous normalization was carried out
- Non-Volatile Memory (NVRAM) is lost for any reason

Always perform the normalizations in environments, especially temperatures, like those in which the subsequent measurements will be carried out. Also, remove any input signals from the 2714 before performing amplitude or frequency normalizations. Although we recommend that you wait a full 15 minutes after power-up before making measurements with the 2714 (it is within advertised specifications by then), it is possible to make them shortly after power-up. If you must make measurements immediately after the instrument is turned on and the NORMALIZATION SUGGESTED message is on screen, carry out a normalization directly. Note, however, that if you do so, the 2714 may require renormalization after it is fully warmed up.

Call up the Utility menu and select item 3, NORMALIZATIONS.

The Normalizations menu enables you to normalize amplitude parameters (AMPLITUDE ONLY), the frequency parameters (FREQUENCY ONLY), or both (ALL PARAMETERS). It takes longer for amplitude normalization than for frequency normalization, and several minutes for both. Routinely select ALL PARAMETERS to ensure the 2714 measures amplitude and frequency as accurately as possible, but if you are in a hurry, you can select only the parameters that are most important to your measurements.

To continue with amplitude and frequency normalization, ensure that all signals are disconnected from the 2714 input. Then select item 0, ALL PARAMETERS.

Typically, you will see a number of changing waveforms and messages on screen telling you which normalizations are being carried out. However, if NVRAM is ever lost, the factory reference normalizations are lost with it (see the If You Lose NVRAM later in this section). Then, regardless of which normalizations you are carrying out, you will receive the following message.

**\*\* ONE OR MORE REFERENCE NORMALIZATIONS HAS NOT BEEN PERFORMED.**

**\*\* FOR OPTIMUM ACCURACY, REFERENCE NORMALIZATIONS MUST BE DONE**

**\*\* CONSULT MANUAL FOR PROCEDURE**

---

## Precautions

The spectrum analyzer is tough but not indestructible. It can be damaged unless the following cautions are observed.

1. Do not apply too large a signal to the input

Never apply signals to the **RF INPUT** connector if their combined amplitude is greater than +70 dBmV (+20 dBm), or if there is a DC component greater than 100 V. If you exceed these input ratings, you can permanently damage the spectrum analyzer.

If necessary, use an external attenuator first. Further, to prevent damaging transients, use maximum RF attenuation when connecting a signal with a DC component. Then remove attenuation as needed to make the measurement. Also be aware that the 2714 is optimized for a -30 dBm input to the first mixer. A larger input signal may lead to nonlinear operation and inaccurate results.

**DO NOT** connect a CATV trunk carrying AC power directly to the **RF INPUT**. The 1<sup>st</sup> mixer can be overloaded making accurate measurements impossible. Also, a power surge might raise the peak AC voltage above the maximum safe input level.

### NOTE

*The maximum safe RF and DC input levels are clearly printed near the signal input jack (RF INPUT).*

2. Do not apply incorrect mains power

The 2714 will accept mains power up to 250 VAC<sub>RMS</sub> (refer to Section 2 for additional information). It is unlikely that you will apply incorrect power while using standard plugs and receptacles in the normal working environment. However, in the field or during abnormal conditions, you might have to connect temporary power. Be certain that any power source connected to the 2714 applies less than 250 VAC<sub>RMS</sub> between conductors or between either conductor and ground. To avoid damage to the source, ensure that it is rated for at least 120 W operation.

stored). Furthermore, this information is saved even after the power is turned off. You can do things like record waveforms in the field and bring them back to the lab with you for further analysis or permanent recording, or store reference waveforms in the lab for comparison in the field.

You can also store settings and waveforms by title as follows.

1. Using the Display menu, create a title for the current display (see Adding Titles and Labels in this section). Call it MY SETTINGS. Turn on title mode and return to the spectral display. Press **[UTIL] [1] [4] [X]**.
2. This saves the settings under item 4 of the Stored Settings/Displays menu. Press **[UTIL] [1]**. Item 4 on the menu is now MY SETTINGS. The settings are recalled like any other, but the title often helps remind you what the settings are used for.

## Normalizing the 2714

***Any control settings can be used***

Normalization is a set of procedures contained in ROM that calculate gain and frequency characteristics of the circuits in the 2714 based on the built-in 100 MHz, 18.8 dBmV calibrator signal. The characteristics must be accurately known to correctly scale and display the analyzed signal. The normalization values are stored in non-volatile memory (NVRAM). Using external signals to achieve even greater measurement accuracy, or to re-normalize the reference if NVRAM should ever be lost is described later in this section under Service Normalizations.

If the 2714 self-test routine detects that the present 2714 gain or frequency characteristics differ significantly from those determined during the previous normalization, the NORMALIZATION SUGGESTED message is displayed on the screen. You should then perform a normalization, although the 2714 remains useable for relative measurements. The NORMALIZATION SUGGESTED message may also appear while the 2714 is warming up, especially if the user-defined power-up settings include a narrow span. This is normal, and you need not perform a normalization unless the message persists beyond the warm-up period. Any time you require the utmost accuracy, we recommend a normalization first. Normalization may be required because of any of the following.

- Circuit or component variation with time (drift)

## Getting Acquainted With Your Instrument

3. Do not allow moisture, dust, or other contaminants inside the case

Electronic circuits do not mix well with water, chemicals, dust, or grit. The case is not water-tight or air-tight, so avoid exposing your instrument to these or other contaminants. Do not place liquid containers on or near the spectrum analyzer where they can be spilled into it. Use the Travel Line rain cover (Option 33), or other suitable covering, when transporting the spectrum analyzer out of doors in inclement weather.

4. Do not handle the spectrum analyzer with undue roughness

Do not physically abuse the spectrum analyzer. It can withstand a fair amount of rough handling but dropping it off a workbench or bouncing it around the trunk of a car or the back of a truck may cause damage. Protect the instrument while transporting it and use it where it cannot be accidentally hit, kicked, or dropped.

5. Provide proper ventilation



*Although the spectrum analyzer can be operated in any orientation, you must ensure that the clearance provided by the feet is maintained on the bottom and that there are at least 50.80 mm (2 in.) of clearance around the other sides. DO NOT block the air intake areas on the sides, bottom, or the exhaust area at the rear. Never run the instrument inside a carrying case.*

---

## System Checkout

After you have observed the foregoing precautions, you are ready to perform the initial system checkout. Checkout consists of "normalizing" the spectrum analyzer and then measuring the frequency and amplitude of the built-in calibration source. In the process, you will become acquainted with the front panel and the display.

## Other User-defined Settings

The remaining items on the Stored Settings/Displays menu can be used exactly as you used USER DEFINED POWER-UP SETTINGS. The difference is that they are not automatically implemented at power-up time, or by the initialization selection; they must be recalled from the Stored Settings/Displays menu.

Turn on the calibrator, and change the frequency to 90 MHz and the reference level to 38.8 dBmV. Save a 16 sweep ensemble mean in register A, and save the max hold values in B. Turn off the calibrator. Call up the Utility menu and select STORED SETTINGS/DISPLAYS. Notice that settings 3 through 8 are blank<sup>3</sup>, and item 9 indicates MORE.

There are, in fact, 34 fields (in addition to last power-down and user-defined power-up) contained on 4 menu pages in which you can save stored settings and displays. Advance to page 4 by repeatedly pressing [9]. Backup to the first page by pressing [BKSP] three times. The register locations currently being displayed are indicated at the top right of each page (R00–R08, R10–R18, R20–R28, R30–R39).

Store the settings you entered earlier in the register 3 location by pressing [3] [X] (if there is a setting already present, delete it or use another location).

Unsave the A and B registers, and turn them off. (If you do not, the CANNOT OVERWRITE SAVED DISPLAY message is displayed when you try to recall settings.)

Reinitialize the 2714 to your user-defined power-up settings by pressing [UTIL] [1] [2] [W]. Now press [UTIL] [1]. Item 3 reads as follows.

AB 90MHZ 38.8DBMV 20MHZ

This message shows the primary control settings that are saved in that location and tells you register A and B waveforms are saved along with the settings.

Press [3] [W]. The control settings and the saved waveforms are both restored. Whenever you save settings (including LAST POWER-DOWN and USER DEFINED POWER-UP), you also store the contents of digital storage registers A, B, and C. This means you can store up to 108 waveforms as well as 36 groups of settings (actual numbers depend on what else, such as user-defined programs, is being

- 3** If your instrument has been used previously, you may find that some or all of the items already contain saved settings and displays.



### Turning On the Spectrum Analyzer

Make sure there is no signal source connected to the spectrum analyzer, and plug in the power cord. Then press the **POWER** switch.

The green LED adjacent to the power switch lights indicating that power is turned on. The LED indicators flash and you hear a few beeps as the 2714 performs its power-up self test.

When power is applied to the 2714, it initializes its front-panel controls to settings stored in memory. If the instrument has been used before, those settings may be user-defined (see User-Defined Power-up Settings in Section 7). If no user-defined settings exist, the 2714 defaults to the factory power-up settings that are permanently stored in initialized RAM (random access memory). The only exception is that the default channel table and channel are replaced by the last selected channel table and channel before power-down.

A display appears on screen almost immediately. You may see the following message.

WARMUP TIME 15 MIN

When the factory-default power-up settings are being used, it is possible to make general observations immediately after the power is turned on. If user-defined power-up settings are implemented, the message **WAITING FOR USER DEFINED POWERUP** appears briefly. The 2714 front panel is locked out while the message is displayed. After the message disappears, the factory-default settings are replaced by the user-defined settings, and you can proceed with your observations.

Whichever settings are used, the **WARMUP** message is displayed. It disappears after a few seconds. Remember, however, that the spectrum analyzer may require a full 15 minutes to be operating within specification. Consequently, measurement errors and system messages can occur within the warm-up period, particularly if you switch the spectrum analyzer to a narrow span or resolution bandwidth (BW) filter.

The settings will be recalled along with any displays saved in registers A, B, or C that are not currently saved, but currently saved registers will not be overwritten. To recall a previously saved display, first unsave its destination register.

### Recall Last Power-down Settings

Turn off the 2714 and then turn it on again. To return the instrument to the settings in effect at the last power down, call up the Utility menu and select item 1, STORED SETTINGS/DISPLAYS. Choose item 0, LAST POWER-DOWN, from the secondary menu that appears. The settings that were in effect the last time power to the 2714 was turned off are immediately recalled.

### User-defined Power-up Settings

100.0MHz	(AUTO SWEEP)	ATTN 10DB
18.8DBMV		VF WIDE
20.0MHz/ 5MHz RBW (AUTO)		10 DB/ CALIBRATOR

The following examples describe using the user-defined power-up settings.

Call up the Utility menu and select item 1, STORED SETTINGS/DISPLAYS. From the secondary menu that appears, select item 2, USER DEFINED POWER-UP. Following the prompt, press **[X]** to store the current settings. You are warned if other settings are already stored as the user-defined power-up. In that case, delete the old settings by pressing **[Y]**, and then **[W]** to confirm the deletion. Then store the current settings.

Turn the instrument power off and back on. During the standby period, the factory default power-up settings are displayed, but immediately afterwards the settings you just stored are automatically implemented.

At power-up the 2714 restores the user-defined power-up settings, if they exist, following the standby period. If they do not exist, it uses the factory default settings. If the user-defined power-up settings include a narrow span, the NORMALIZATION SUGGESTED message may appear. The message should disappear following warmup as soon as you use a control.

## Initial Normalization

You may also see the following phrase during warmup.

### NORMALIZATION SUGGESTED

Normalization is a process by which the 2714 measures and stores its own calibration parameters using a built-in reference. When this message appears, the instrument is reporting that its self-test feature has determined that its performance no longer matches that predicted by the previous normalization. It is not unusual for the message to appear during the warm-up period, especially if a narrow resolution bandwidth filter is called for by user-defined power-up settings, or if the ambient temperature is different than that at which the previous normalization was performed. If the message remains (or reappears) after the warm-up period, a new normalization should be carried out. Normalization ensures the utmost accuracy when making measurements. We suggest that, whenever maximum accuracy is required, you allow your instrument to reach a stable operating temperature in the environment in which the measurements will be carried out and then perform a normalization before making the measurements.

Perform a normalization to ensure the calibration of the 2714 and to verify its operational status. Additional information about normalization may be found in Section 7 under Normalizing the 2714.

To normalize the 2714, ensure that no external signals are connected to the 2714, then press [UTIL] and [3]. This calls up a menu that offers you a choice of normalization processes.

Select ALL PARAMETERS by pressing [0].

Normalization should begin immediately and continue without interruption until it is completed. Normalizing all parameters requires several minutes. During the process, you will see various displays and messages which keep you informed of progress, but do not require action. The process ends with an audible beep and the message NORMALIZATION COMPLETE, indicating satisfactory operation. If you receive any other message terminating this initial normalization, repeat the procedure. If the message persists, contact your Tektronix Service Center.

- The resolution bandwidth can be set to AUTO (the default), 300 Hz, 1 kHz, 3 kHz, 10 kHz, 30 kHz, 100 kHz, 300 kHz, 1 MHz, or 5 MHz — if you enter another value, the 2714 will convert it to the nearest available value
- This menu provides the only method of manually setting the video filter bandwidth. The video filter bandwidth can be set to AUTO (in which case it is 1/100 of the resolution bandwidth in normal mode) or fixed from 3 Hz to 300 kHz in a 1–3 sequence (3 Hz, 10 Hz, ... 100 kHz, 300 kHz); other values will be converted to the nearest allowable values
- Selecting item 6, VERTICAL SCALE, calls up another menu that enables you to select any of the normal values of 10 dB/div, 5 dB/div, 1 dB/div, or Linear
- Sweep rate can be set from 1  $\mu$ s/div to 2 s/div in a 1–2–5 sequence. Other values will be converted to the nearest allowable value. Rates faster than 100  $\mu$ s/div can be used only with analog displays (that is, with display storage turned off)

Press [UTIL] to return to the spectral display and view the screen you have created.

Return to the Keypad Entered Settings menu and re-enter a span/div of 20 MHz and a reference level of 28.8 dBmV. Restore the spectral display by pressing any menu button.

## Save and Recall Settings and Displays

The 2714 enables you to save and recall up to 36 sets of control settings and any saved displays that accompany them. These are in addition to the factory default power-up settings that are permanently stored in the instrument. The 2714 also automatically saves the settings/displays in use (in location 0) when it is powered down. You can manually save up to 35 additional setting/display groups, and designate one group as the power-up settings.

A general word of caution: the 2714 will not allow you to destroy a display currently saved in registers A, B, or C. If you attempt to recall settings (with or without corresponding displays), you will receive the message CANNOT OVERWRITE SAVED DISPLAY.

## Restoring the Factory Default Settings

To ensure a uniform starting point for the calibration signal measurement, restore the factory-default power-up settings by pressing [UTIL] [1] [1]. This stores the factory-default settings whenever the 2714 is in normal spectral display mode (and most other modes). It is a handy method of returning to a fixed set of conditions if you get lost.

The initialization sets the reference level to maximum. With the reference level at maximum, the incoming signal undergoes maximum RF attenuation. This is a safeguard designed to prevent overloading the first mixer stage of the spectrum analyzer.



*The span is set to maximum so you can observe the entire input frequency range of the spectrum analyzer. This prevents you from overlooking a large off-screen signal that might overload the input. We urge you to use these settings whenever you connect a new or unknown signal to the spectrum analyzer.*

## The Initial Display

Figure 3-1 shows what the spectrum analyzer screen looks like after initializing the instrument settings. The displayed spectrum represents the noise floor of the spectrum analyzer. The noise floor is the amplitude of the noise generated internally by the spectrum analyzer itself and passed through the resolution bandwidth filter. Narrowing the resolution bandwidth lowers the noise floor, because noise power is directly proportional to the resolution bandwidth.

## Menu-entered Control Settings

900.0MHz	(AUTO SWEEP)	ATTN 50DB
68.8DBMV		VF WIDE
180MHz/ MAX		10 DB/
5MHz RBW (AUTO)		

Although the 2714 controls are most conveniently activated or set using the dedicated front-panel controls, the Utility menu provides a method of setting all the major control functions from a single submenu. This feature is especially useful when you are setting up a new measurement and know ahead of time how the 2714 is to be configured. The following example uses the Utility menu to reset the center frequency, reference level, and span. You could also set the resolution BW, video filter, vertical scale, and sweep rate.

Turn on the calibrator, and then press **[UTIL] [2]** to select the **KEYPAD ENTERED SETTINGS** from the Utility menu. This item enables you to set instrument controls to specific values from a single menu without having to use the front-panel controls.

Select item 0, **FREQUENCY**, from the Keypad Entered Settings menu. Following the prompt, enter a value of 100.000 MHz for the center frequency. The Keypad Entered Settings menu shows the frequency to three decimal places, whereas the on-screen readout displays the specified frequency from zero to four decimal places depending on the span. Both values are truncated figures, but the 2714 still controls the frequency to the nearest Hertz specified. The number of decimal places in the on-screen readout is commensurate with the screen resolution at the selected span.

You can also enter decimal values for the reference level and span. Select items 1 and 2 and enter values of 24.52 dBmV and 22.6832 MHz/division, respectively. The 2714 rounds and stores the reference level to one decimal place (0.1 dB). The span is rounded and stored to three decimal places, but in the spectral display both the reference level and span are shown rounded to one place.

Leave the remaining parameters set as they are, but note the following settings.

- RF attenuation can be set to **AUTO** (the default), or fixed from 0 to 50 dB in 2 dB step

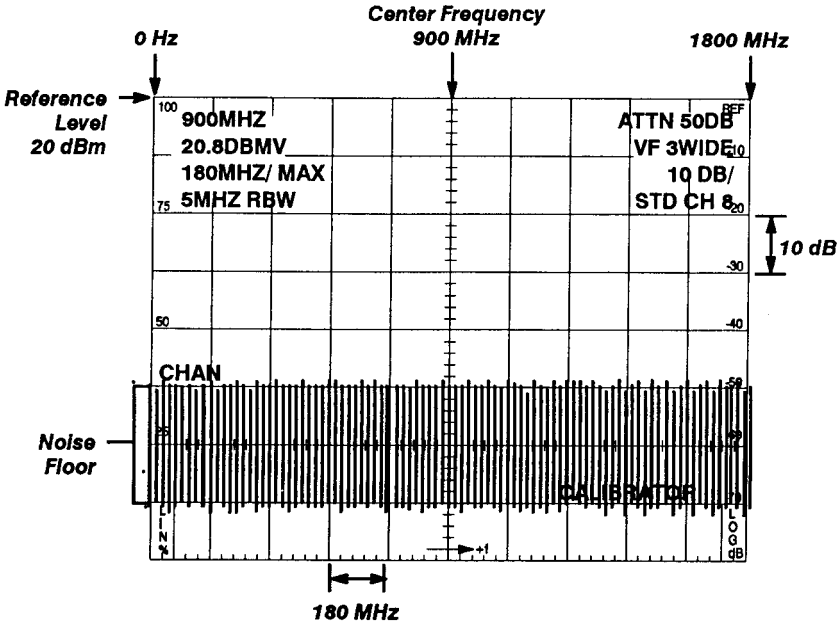

Figure 3-1: Display with Factory Default Power-up Settings

The noise appears as a thick, irregular band across the bottom portion of the screen. To achieve this appearance, digital display storage is used. The unique max/min display shown here is designed to resemble the analog spectra that the spectrum analyzer inherently produces.

To see the analog display, press **[D]**. This turns off the D storage register (the only one currently enabled). When all registers are turned off, the analog display appears. Toggle the D register on and off several times by repeatedly pressing **[D]**, and notice the similarity between displays. Then leave the D register turned on.

To obtain the max/min display, the maximum and minimum amplitudes of the analog spectrum are each sampled at 256 points. Plotting the two interleaved sets of 256 points produces the 512 point graph of the spectrum that you see. This display not only imitates the analog spectrum, but can also assist in detecting low-level signals by more effectively showing the characteristic void they produce under the noise floor.

Return to the spectral display. Connect an antenna or cable drop to the 2714 as outlined in Appendix A and tune to a strong video carrier (choose an unscrambled channel). Adjust the reference level until the signal peak is at the top line. The signal level is very important for proper performance<sup>2</sup> and must also be well above the noise floor.

Call up the DEMOD menu and choose item 3, BROADCAST (AM) VIDEO. When item 3 is activated, the 2714 presets a number of measurement parameters in order to generate a TV picture. You may be able to obtain a slightly better picture by changing some settings.

Vary the reference level (use the 1 dB step size), and experiment with the **INTENSITY** control to obtain optimum contrast. Use the outer knob of the **LEVEL** control to change vertical size and obtain a flicker-free display. Use the **SWEEP** arrow keys to change horizontal size.

Turn off the video monitor by toggling item 3 of the DEMOD menu to OFF. When the monitor is disabled, the settings used prior to entering monitor mode are restored; any changes you have made while using the video monitor are overwritten.

Reinitialize your instrument by pressing [UTIL] [1] [1].

---

## UTIL

The Utility menu provides access to system configuration and initialization features, front-panel settings and waveform storage facilities, instrument normalization and diagnostics, and miscellaneous other functions. Some of the selections within the Utility menu and its submenus are used by service personnel to troubleshoot the 2714. Therefore, not all selections are discussed here.

If the instrument is not already initialized to factory settings, press [UTIL] [1] [1].

- 2** This can be conveniently done by placing the marker on top of the video carrier and selecting item 3, MARKER TO REFERENCE LEVEL, from the MKR/FREQ menu.



The spectral display is overlaid by a 32-character wide by 16-character high text screen. Not all of the text fields are displayed all the time, and you can turn the text screen on and off by pressing [READOUT].

The top portion of the text screen contains two data readout columns that are present whenever the text screen is turned on. The readouts show spectrum analyzer settings or measurement results. Figure 3-2 shows the data normally displayed in the readout columns.

<b>Center frequency</b>	<b>Marker frequency</b>
<b>Reference level</b>	<b>Marker amplitude</b>
<b>Horizontal scale factor</b>	<b>Vertical scale factor</b>
<b>Resolution bandwidth</b>	<b>Channel table and number</b>
<b>(Various messages may appear as needed below the data readout columns)</b>	

**Figure 3-2: Normal On-screen Data Readouts**

With the spectrum analyzer in the MAX SPAN mode (indicated by MAX following the horizontal scale factor), the resulting spectrum spans the entire input frequency range. In this mode, the first item in the left column lists the frequency at the location of the frequency marker (the intensified spot on the display).

The types of information in the right column may change depending on operating mode. You will learn when to expect alternate information as we discuss the various modes.

Below the readout columns, messages and indicators appear as warranted, and numeric instrument settings can be entered.

### Control Panel Basics

The control panel has several characteristics included to make it easy and convenient to operate.

- Controls with related functions are generally grouped together — the groupings (Function Blocks) are defined by the borders or background color surrounding the controls

## Video Demodulation

<b>100.0MHz</b>	<b>(AUTO SWEEP)</b>	<b>ATTN 2DB</b>
<b>18.8DBMV</b>		<b>VF 300KHz</b>
<b>1.0MHz/</b>		<b>10 DB/</b>
<b>300KHz RBW (AUTO)</b>		

The video demodulator enables you to view broadcast or satellite video transmissions. This is useful for identifying signals and determining the nature of interference.

Call up the DEMOD menu. Item 3 is an on/off toggle that may indicate BROADCAST (AM) VIDEO or SATELLITE (FM) VIDEO, depending on the mode that was last selected. The BROADCAST mode is used for off-air or cable TV signals; SATELLITE is used, for example, when viewing FM video signals at the output of a block down converter (LNB). In the following example we will use the AM monitor mode to view an off-air or cable TV signal. First, here is some information to keep in mind.

- The carrier-to-noise ratio must be sufficiently large (at least 30 dB in a 4 MHz bandwidth in BROADCAST mode, 10 dB in a 30 MHz bandwidth in SATELLITE mode), but it is possible to get a poor quality display at slightly lower C/N's
- You will not be able to satisfactorily monitor scrambled or syncless signals in either mode
- The video carrier in either mode should be placed at the reference level for satisfactory operation
- Energy dispersal dithering is generally not a problem in the SATELLITE mode

To continue with the example, select item 9, VIDEO SETUP TABLE, from the DEMOD menu. Toggle item 0 of the Setup Table to the BROADCAST mode. Then toggle items 1 and 2 to the proper polarities. If you do not know the polarity, set SYNC POLARITY to POSITIVE and VIDEO POLARITY to NEGATIVE. These are the standards for normal U.S. broadcast television. You can change them later to accommodate other standards if the video is inverted or sync cannot be achieved.

## Getting Acquainted With Your Instrument

- Dedicated controls permit quick selection of important measurement functions — the controls are defined by background color; for example
- Arrow keys directly increase and decrease critical control settings
- Menu keys located in the **MENUS** function block call up lists of operator-selectable features
- A numeric keypad permits selection of menu options and entering of critical measurement parameters
- Terminator buttons in the keypad block designate the units for numeric entries with a single keystroke
- An immediate entry mode that enables you to enter arbitrary values for the channel/frequency, span, and reference level directly from the keypad
- Red LED function status indicators adjacent to certain buttons indicate when the functions are active
- Green LED register status indicators illuminate when any storage register contains a saved waveform

The controls most fundamental to spectrum measurements (**[CHAN/FREQ]**, **[SPAN/DIV]**, and **[REF LEVEL]**) are located in a single central function block with a dark gray background. These controls can be conveniently set using either the arrow keys or immediate entry mode.

The arrow keys enable you to instantly change control settings. **[↵]** and **[↶]** move according to the channel table selection. The arrow keys are active whenever the spectrum analyzer is in the spectral display mode.

In immediate entry mode, you press the key corresponding to the parameter you wish to set (**[CHAN/FREQ]**, **[SPAN/DIV]**, or **[REF LEVEL]**), type the parameter value on the keypad, and press the appropriate terminator key to complete the entry. The value appears on screen as you type.

Each of the terminators (**[W]**, **[X]**, **[Y]**, and **[Z]**) can represent more than one unit as indicated by the legend to the right of each key; however, the keys are context sensitive. If an entry represents a frequency, the indicated frequency unit is selected automatically when you press the key. If dBs are required, the indicated dB unit is selected, and so on for all of the units.

The DEMOD menu appears. Select item 2, FM DEMODULATOR. The LED adjacent to FM VOL on the front panel lights, the spectral display reappears, and you may hear the 2714 sweeping. If you hear nothing, turn the outer barrel of the LEVEL control clockwise to increase the volume. Press **[ZERO SPAN]** to hear whatever is being transmitted by the station. Leave the 2714 in zero span, and tune it as you would a radio receiver using the FREQ/MKRS knob. The signal level rises as you tune in stations and falls to the noise floor when no station is present.

When you are finished, turn off the FM demodulator by selecting item 0, OFF, from the DEMOD menu, and press **[ZERO SPAN]** to return to the normal spectral display.

## Listening To AM Transmissions

To listen to AM transmissions, connect an antenna to the 2714 as outlined in Appendix A. The antenna will probably need to be much longer than for FM. Set the center frequency to 1 MHz, span to 10 kHz/div, sweep and resolution BW to AUTO, and calibrator off. Increase the signal height until you can see signal peaks in the 500 kHz to 1.6 MHz area (this is the medium-wave broadcast band). Change the center frequency until one of the peaks is centered. Press **[DEMOD]**, and select item 1, AM DEMODULATOR. The LED adjacent to AM VOL on the front panel lights, and the spectral display reappears. Press **[ZERO SPAN]** and adjust the LEVEL control as needed until you hear whatever is being transmitted by the station.

Leave the 2714 in zero span, and use the FREQ/MKRS knob to tune other stations. When you are finished, turn off the AM demodulator by selecting item 0, OFF, from the DEMOD menu.

## Listening To AM or FM Transmissions

To hear AM and FM stations, select AM DEMODULATOR and FM DEMODULATOR simultaneously (both AM VOL and FM VOL LEDs will light). This approach is convenient if you do not know whether the signal is AM or FM, or for simply finding audio modulated signals and then switching on only the AM or FM demodulator to determine which type of modulation is being used.

Many keys are toggle-action. The ability to undo an action, including menu selection, by pushing the same button or sequence of buttons that carried out the action is typical of operations performed on the 2714.

To observe the toggle action, press **[VID FLTR]**. The red video filter LED illuminates, and the trace shrinks vertically as the filter turns on and averages the noise.

Press **[VID FLTR]** again. The noise spectrum expands to its original size as the filter is turned off, and the LED goes out.

### Sounds

The 2714 can emit tones under the following conditions.

- During power-on self test
- When an abnormal condition occurs
- When a message appears
- When a key is pressed

The instrument emitted self test beeps when it was powered up. The beep can be set to sound when an error occurs, when a key is pressed, when either happens, or can be set to never sound.

If the error alert is turned on and an abnormal condition exists, such as a request to extend a measurement parameter beyond its range, the 2714 emits a high-level beep. A message is simultaneously displayed on screen describing the abnormal condition.

The 2714 is equipped with AM and FM demodulator circuits that extract the audio signals on amplitude or frequency modulated RF signals. The demodulated audio is reproduced on the built-in speaker. This feature can be used to identify most voice channels based on their content or call signs and can help to identify others by enabling you to determine the type of modulation (frequency shift keying, pulsed CW). For better quality audio or private listening, use the headphone jack on the right side of the 2714. The AM/FM demodulators are covered in the discussion of the DEMOD Menu in Section 4.

The foregoing technique provides a quick look at unidirectional frequency deviation. The carrier frequency is at the reference level, and a downward excursion represents a deviation below the carrier. If the FM spectrum is symmetrical, the peak to peak deviation is twice the unidirectional amount. In the example above, 7 divisions is 70 kHz (at 10 kHz/div), and the peak to peak deviation is approximately 140 kHz.

To see the deviation in both directions, try the MAX HOLD technique outlined in Measuring Occupied Bandwidths previously in this section. For extremely accurate deviation measurements, the Bessel null approach should be used; see Tektronix application note 26W-7037-1, *Spectrum Analyzer Fundamentals*.

---

## DEMODO

100.0MHz	(AUTO SWEEP)	ATTN 2DB
18.8DBMV		VF 300KHz
1.0MHz/ 300KHz RBW (AUTO)		10 DB/

The DEMODO menu provides a means of listening to AM or FM modulation on the signals being analyzed and activating the video monitor mode.

### Listening To FM Transmissions

Listening to signals often helps to identify the source. A built-in speaker is provided, but if higher fidelity is needed, or you are using the 2714 in a noisy location, headphones can be used. A 1/8" miniature phone jack is located near the front of the right side of the 2714.

To experiment with the FM demodulator, connect an antenna or cable to the 2714 as outlined in Appendix A. Change the signal height and center frequency until you see signal peaks in the 88 to 108 MHz FM broadcast band (if you do not have broadcast FM in your area, you can tune to a TV station audio carrier). Set the center frequency to coincide with one of the peaks and press [DEMODO].

### The Built-In Calibrator

The 2714 is equipped with a built-in calibration source. The calibrator for the 2714 has no external "Cal Signal" output. Instead, the calibrator resides in the 2714 and can be "connected" to the input path without the need for external cabling by selecting the proper Input Menu option.

To call up the Input Menu, press **[INPUT]**.

Item 9 specifies a CAL SIG @ 100MHz 18.8DBMV. The calibrator is a CW signal with a fundamental frequency of 100 MHz at an amplitude of 18.8 dBmV (-30 dBm). Higher order harmonics at lower levels are also present. Item 9 toggles the calibrator on and off.

Turn the calibrator on by pressing **[9]**.

The screen reverts immediately to the spectral display. The word CALIBRATOR now appears near the bottom right of the screen signifying that the calibrator is enabled. You should see a few signal peaks towards the left of the display. These are the fundamental and harmonics of the calibrator signal. If you do not see them, it is because the amplitudes of the harmonics may be lower than the noise floor of the 2714.

#### NOTE

*When the calibrator is enabled, the normal RF input is disconnected internally from the input attenuator and cannot be viewed.*

Disable the calibrator by pressing **[INPUT] [9]**.

---

## Making Your First Measurement

The following two types of measurements can be made with the 2714.

- CATV measurements
- Non-CATV measurements

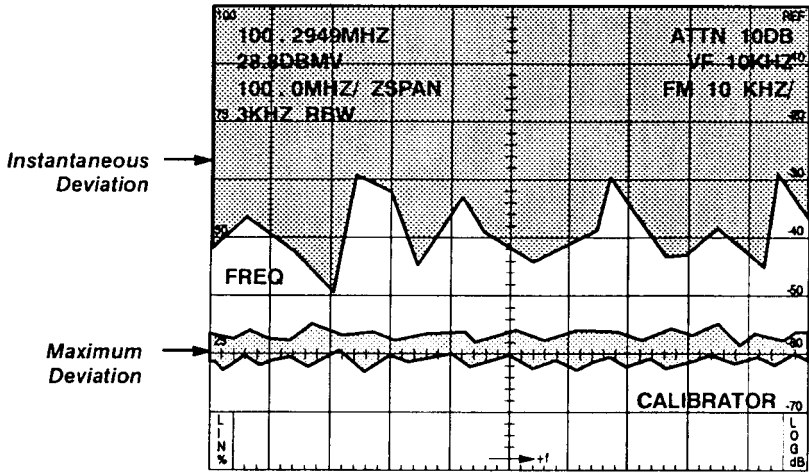

**Figure 7-14: Instantaneous Frequency Deviation and Maximum Observed Deviation**

The vertical scale can be changed in a 10-5-1 kHz/div sequence. Cycle through the frequency deviation scales by repeatedly pressing [10/5/1].

To check the maximum deviation, set the vertical scale to 10 kHz/div, and using the Display menu, select MIN HOLD IN WFM A. Let the data accumulate for two to three minutes. A ragged horizontal waveform develops indicating the maximum frequency excursions during the observation period.

To read out the frequency deviation with the marker, turn the marker on and leave only the A register active. Move the marker to the point where you want the measurement.

#### **NOTE**

*Because of the FM demodulator bandwidth, the modulating signal used in the deviation monitor mode should consist of normal program material or a single tone in the audio frequency range.*



### Selecting a Channel Table

The factory defaults set the 2714 in the normal (CATV) mode.

The resolution bandwidth (RES BW) is set to 300 kHz, allowing you to see most of the detail in the channel band.

Connect a cable TV feed to the RF INPUT. Press **[CATV/APPL] [8] [1]** to call up a menu of channel tables. Initially, there are three factory-installed tables in this menu. You may choose to add other tables to this menu using the PC-based software that comes with the 2714.

Press **[0]** to select the standard (STD) table. The reference level is then set so the peak of the visual carrier is approximately one division down from the top graticule line, and the center frequency and span are set so the channel band is centered on the screen horizontally. Press any menu button to return to the spectral display.

Notice that the abbreviation CHAN appears at left center of the screen. The CHAN indicator tells you that you can enter the channel number directly from the keypad. This is done by keying in a permissible number followed by the **[W]** terminator key (labeled CHAN).

Select an active channel (channel 8 for this exercise) by pressing keypad numbers corresponding to the desired channel. The numbers you press appear on screen to the right of CHAN. If you make a mistake, you can correct it by repeatedly pressing the backspace key until the incorrect number disappears and then entering the correct number.

After the correct number has been entered, press **[W]**. This key can represent units of CHAN, GHz, SEC, or V. Because you selected an entry mode that requires a channel, the 2714 correctly interprets the currently displayed entry as STD CH 8.

Direct frequency entry capability is available from the front panel. However, the 1 GHz terminator is not available in the normal mode, because it is reserved for channel selection.

You are now ready to perform a CATV measurement.

### Typical CATV Measurement

This example is one of several CATV measurements and allows you to measure the visual and aural carrier levels over the selected channel.

Note that the only actions needed to make a measurement are the following.

Experiment if you wish, and then turn off OCCUPIED BW, MAX HOLD A & B, and register B. The Occupied BW mode can be turned off by pressing **[APPL] [4]**, or by turning off all display registers.

Turn register D back on.

### Viewing Instantaneous Frequency Deviation

<b>100.0MHz</b>	<b>(AUTO SWEEP)</b>	<b>ATTN 2DB</b>
<b>18.8DBMV</b>		<b>VF 300KHz</b>
<b>1.0MHz/</b>		<b>10 DB/</b>
<b>300KHz RBW (AUTO)</b>		

Normally, the display you see on the 2714 represents the input signal after it has been AM detected. The result is a conventional spectral display of signal power vs. frequency. However, by selecting FM DEVIATION MODE, you can view instantaneous frequency variations vs. time.

You need a frequency modulated signal to demonstrate this mode. Ensure that the calibrator is turned off, and connect a short antenna or CATV tap to the 2714 input as outlined in Appendix A. Adjust the reference level until you can see individual FM broadcast or TV sound carrier signal peaks, and then tune the 2714 until a strong signal is centered. Your display might resemble Figure 7-12 from the Measuring Occupied Bandwidths discussion.

Change the span to 100 kHz/div. Press **[APPL]** and select item 7, FM DEVIATION, from the Applications menu.

The 2714 reverts to a waveform display mode in zero span. The bottom line of the right column reads as shown below.

FM 10 KHz/

This indicates that FM demodulation is now being used and that the vertical scale factor has changed to 10 kHz/division. The vertical axis now measures frequency deviation.

The sweep being displayed should resemble the upper trace in Figure 7-14. It is an approximate indication of the instantaneous frequency deviation.

## Getting Acquainted With Your Instrument

- Select a channel table
- Select a measurement channel
- Select a measurement
- Run the measurement

The channel table and measurement channel selected at power down will be remembered when power is re-applied to the 2714. Therefore, the only thing that needs to be selected after that is the desired measurement.

Items 1 through 4 on the second page of the CATV MEASUREMENTS menu are toggle-type functions. For example, if you select VIEW MODULATION (LINE) with **[CATV/APPL] [9] [2]**, you get a preselected VITS line. You must make the same selection or select another measurement to disable the line display.

Press **[CATV/APPL] [1]** to call up the CARRIER LEVELS menu.

Press **[0]** to select/run the Carrier Levels.

The 2714 starts the measurement routine (much like performing a center measure on the visual and aural carriers). When the measurement is finished, the 2714 returns to the spectral display. Two lines near center screen display the measurement results. One line displays the visual carrier amplitude and frequency in absolute values, and the second line displays aural carrier amplitude and frequency as offsets from the visual carrier values.

Press **[CATV/APPL]** to recall the CARRIER LEVELS measurement menu.

Press **[1]** to store the measurement results.

Press **[2]** to display the measurement results. See Figure 3-3 for a typical display. Press **[W]** to display the last stored results (if they exist).

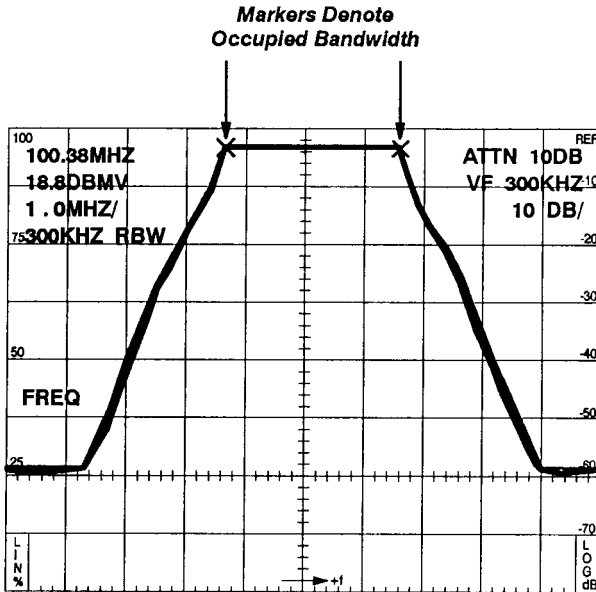

**Figure 7-13: OCCUPIED BW Mode With MAX HOLD**

- The signal spectrum at the edges of the screen should be down at least 40 dB from its peak
- The signal peak should be at least 40 dB greater than the displayed noise
- The resolution bandwidth filter must be 1/5 or less of the occupied bandwidth — a resolution bandwidth filter that is too wide will artificially broaden the occupied bandwidth (remember how the 5 MHz resolution bandwidth filter made the calibrator signal look like it is 5 MHz wide,
- Only vertical scales of 5 or 10 dB/div can be used
- There should be no signal on screen except the desired signal; other signals, including the zero Hertz spur, will contribute some inaccuracy

For optimum amplitude accuracy, keep the signal peak near the reference level.

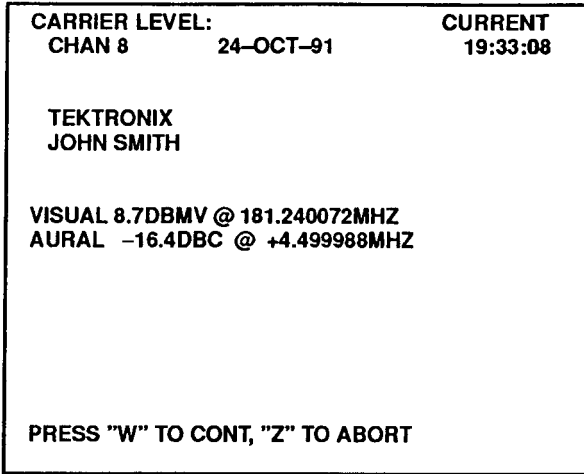

**Figure 3-3: Typical Measurement Result Display**

Press [3] to print the measurement results. (The spectrum analyzer must be connected to any printer that is capable of printing text.)

Press [4] to print the stored measurement results.

Press the [9] key to deselect the CARRIER LEVELS measurement.

Disconnect the cable TV feed from the RF INPUT.

### **Making Your First Non-CATV Measurement**

This goes through the procedure of verifying the frequency and amplitude of the calibration signal. Although the calibration signal is used, the measurement technique is the same for any continuous signal. In the process, you will learn to use three of the most important controls on the spectrum analyzer and to confirm that the major functions of the spectrum analyzer are operating correctly.

Recall FACTORY DEFAULT POWER-UP settings by pressing [UTIL] [1] [1].

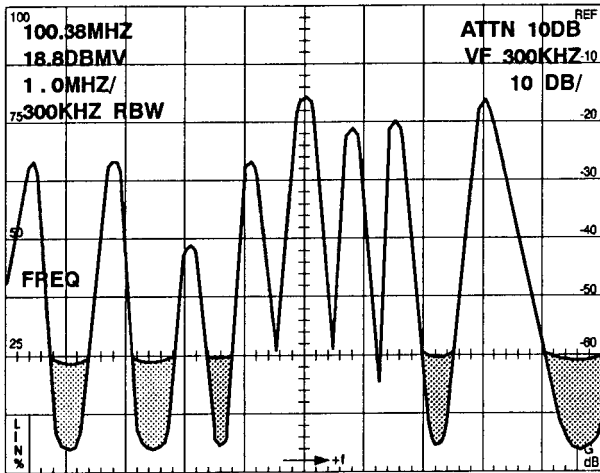

Figure 7-12: Portion of U.S. Broadcast FM Band

The right-hand data column will display something similar to the following.

OBW 57.36KHZ  
@ 90%

Because the signal varies considerably from sweep to sweep, the markers jump around the screen and you will not get a consistent occupied BW reading.

Activate MAX HOLD in register B and turn off register D. Remember that the markers are present only on the highest priority waveform. In a short time a broad spectral peak develops, and the OBW reading begins to settle to a constant value. Figure 7-13 shows a typical MAX HOLD waveform from an FM stereo broadcast. The relatively sharp skirts near  $\pm 70$  kHz denote the upper and lower limits of frequency deviation.

To obtain best frequency accuracy when making occupied BW measurements, as with signal bandwidth measurements, use small spans/division (spread the signal over as much of the screen as possible) subject to the following limitations.

The factory defaults set the RF attenuation to 50 dB. This affords the most protection to the spectrum analyzer, because any signal at the input undergoes maximum attenuation before reaching the power-sensitive mixer circuit. We recommend that you use this setting when connecting unknown signals to the spectrum analyzer.

Press **[CATV/APPL] [8] [0]** to disable the CATV mode.

Enable maximum span and AUTO RES BW by pressing **[MAX]** then **[AUTO]** (in the RES BW block). The span goes to 180 MHz per division, and the resolution bandwidth goes to 5 MHz. This is maximum span and is indicated by the word MAX in the span readout. This is the safe setting for introducing new signals. It enables you to view the entire measurement range (1.8 GHz) of the spectrum analyzer. If a smaller span is used, large signals can be present off screen.

### NOTE

*The total signal power (that is, all signals on screen or off added together), not just the signal of interest, must remain below +70 dBmV. With a small span, it is also possible to reduce the attenuation to view a low level, on-screen signal while inadvertently allowing an off-screen, high-level signal to saturate the mixer, causing spurious responses and possibly even damaging the mixer.*

Press **[INPUT] [9]** to turn on the built-in calibrator.

### NOTE

*The amplitude of the internal calibrator is 18.8 dBmV. This places the peak level at the top graticule line with the reference level set at 18.8 dBmV and 0 dB internal attenuation.*

To measure the calibration signal, you are going to use the three primary controls on the spectrum analyzer. These are located in the central dark gray function block and shown in Figure 3-4. These and the **FREQ/MKRS** knob to the left are the controls you will use most often. In general, you can make most measurements with only these

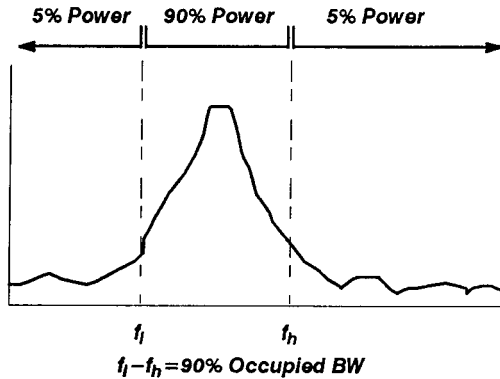

**Figure 7-11: Illustration of Occupied BW Measurement**

If the accumulated power does not precisely equal half the power not-in-the-occupied bandwidth (the usual case), the 2714 linearly interpolates between frequency cells to arrive at better frequency estimates.

#### **NOTE**

*The occupied bandwidth mode always works on the digitally sampled signal. Therefore, different results can be obtained in PEAK and MAX/MIN modes unless video filtering is used to minimize post-detection noise.*

You can demonstrate occupied bandwidth mode using a broadcast signal.

Ensure that the calibrator is turned off, and connect a short antenna or CATV tap to the 2714 input as outlined in Appendix A. Adjust the reference level until you can see individual FM broadcast or TV sound carrier signal peaks, and then tune the 2714 until a strong signal is centered. Your display might resemble Figure 7-12.

Press **[CATV/APPL]** to return to the Applications menu, and choose item 4, OCCUPIED BW. The spectral display reappears with both markers active. Set the span to 25 kHz/div, and recenter the signal, if necessary.



controls, although you will find that other controls and menu features enable you to make many measurements more quickly and conveniently.

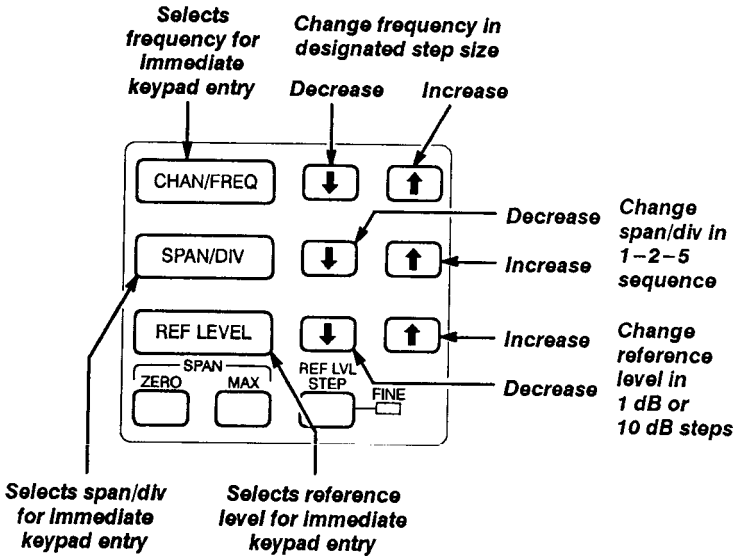



Figure 3-4: The Primary Controls

First, raise the displayed signal height by reducing the reference level. The reference level represents the signal power needed to deflect the displayed spectrum to the top graticule line. The 2714 provides several methods of directly changing the reference level. The most convenient method is to press the arrow keys.

Reduce the reference level 30 dB by pressing [  ] to the right of [REF LEVEL] three times. For numeric entry, the W key terminates any channel number; whereas, the X, Y, or Z keys terminate channel/frequency entry. On channel/frequency, the 2714 selects the channel closest to the new channel/frequency. Figure 3-5 shows what the resulting display should look like, although some of the signal peaks on your spectrum analyzer may have slightly different amplitudes than those shown. Notice that both the reference level and RF attenuation readouts have decreased 30 dB (the reference level is 38.8 dBmV and the RF attenuation is 20 dB).

## Measuring Occupied Bandwidths (OBW)

900.0MHz	(AUTO SWEEP)	ATTN 50DB
68.8DBMV		VF WIDE
180MHz/MAX		10 DB/
5MHz RBW(AUTO)		

Measuring occupied bandwidths is similar to measuring signal bandwidths, except that the 2714 determines the bandwidth that contains n% of the signal's energy rather than the bandwidth enclosed by the x dB down points.

To determine the occupied bandwidth, the 2714 first sums the signal power in all 512 frequency cells of the displayed spectrum, ignoring any contributions more than 40 dB below the signal peak. (This is the total displayed signal power,  $P_t$ .) It then sums the power in the cells starting at the left-hand edge of the screen until the accumulated power equals or exceeds the following.

$$P_t \times \frac{1}{2} \left(1 - \frac{n}{100}\right)$$

$P_t$  = total signal power

$n$  = percentage of signal power within the occupied BW

It then performs a similar calculation starting at the right-hand screen edge. That is, it finds the frequency cells, both above and below the signal, beyond which half the power not-in-the-occupied bandwidth resides. The frequency difference between the upper and lower cells is the n% occupied bandwidth.

For instance, if you specify the 90% occupied bandwidth, the 2714 first computes the total signal power. Next, it sums the signal power in the cells starting at the left-hand edge until it accumulates 5% of the total. (The percent signal power not-in-the-occupied bandwidth is (100% - 90%) = 10%, and half of it is below, and half above, the occupied BW). See Figure 7-11.

## Getting Acquainted With Your Instrument

Normally the arrow keys change the reference level 10 dB per press, but in **FINE** mode the value changes 1 dB per press. Another method is to set the reference level to 20.8 dBmV, less than half a division above the expected signal amplitude. We choose this value for the following reasons.

- Signal amplitudes are read out and displayed most accurately when they are near the reference level.
- 2 dB provides a small amount of “headroom” in case the signal should be slightly larger than anticipated.

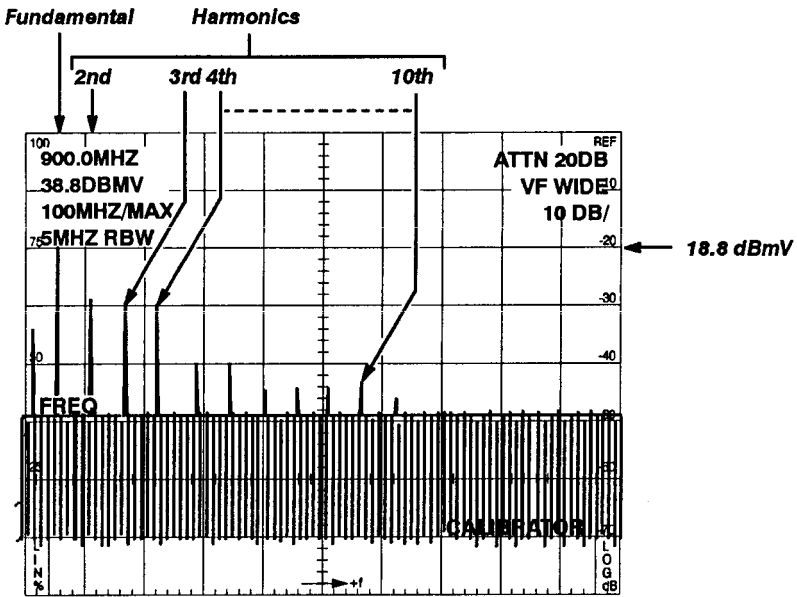

Figure 3-5: Callibrator Signal and Harmonics

To specify a pre-determined value, first press **[REF LEVEL]** to place the reference level in the immediate entry mode. The abbreviation REFL will appear at left center of the screen.

The REFL indicator tells you that you can enter the reference level directly from the keypad by typing a permissible value followed by an appropriate terminator key.

To see how SIGNAL SEARCH works, turn on the calibrator and reset the following 2714 controls to search the frequency range from 55 to 550 MHz.

<b>SPAN/DIV</b>	<b>5.0MHZ</b>
<b>RESOLUTION BW</b>	<b>300.0KHZ</b>
<b>REFERENCE LEVEL</b>	<b>28.8DBMV</b>
<b>VIDEO FILTER</b>	<b>300.0KHZ</b>

Press **[APPL] [3]**. Choose item 0, BEGIN FREQ, and enter 55 MHz. Then choose item 1, END FREQ, and enter 550 MHz. The frequency and amplitude of all signals within the specified frequency range that are below the reference level but above the threshold are stored. The threshold is normally set by the 2714 at approximately one division above the lowest signal peaks (usually noise), but you can reset it manually if desired with **[MKR/FREQ] [0]**. See Setting the Signal Threshold earlier in this section for details.

Start the search by selecting item 2, START TEST, the measurement parameters change, and the message SIGNAL SEARCH IN PROCESS is displayed while the search is occurring. The center frequency will change as each search range is completed. When the search is complete, the message disappears and the 2714 is reset to its original measurement parameters.

Press **[UTIL] [4] [2]**, and then press **[0]** until the status indicator reads CRT (this feature is explained in the UTIL discussion later in this section). Press **[UTIL]** again, and then reselect the SIGNAL SEARCH MENU from the Application menu. Notice that the number of signals detected is displayed at the end of item 3, DISPLAY RESULTS. Select item 3.

The SIGNAL SEARCH RESULTS table appears. Five signals are listed (the calibration signal fundamental and its first four harmonics). The amplitude and frequency of each are indicated.

Return to the spectral display by pressing **[APPL]**.

### NOTE

*In the spectral display mode, the abbreviation for the control last placed in the immediate entry mode remains on screen until another control is chosen. When a control is in the immediate entry mode, repeated settings for that control can be entered without having to press **[CHAN/FREQ]**, **[SPAN/DIV]**, or **[REF LEVEL]** again. Only the primary controls can be placed in the immediate entry mode.*

Set the reference level to 20.8 dBmV by pressing **[2] [0] [.] [8]**. The numbers you type appear on screen to the right of REFL. If you make a mistake, you can correct it by repeatedly pressing **[BKSP]** (the backspace key) until the incorrect number disappears and then entering the correct value.

After the correct number has been entered, press **[Y]**. This key can represent units of **kHz** or **+dB**. Because you selected an entry mode (immediate reference level entry) that requires decibels, and because the factory-default unit is dBmV, the spectrum analyzer correctly interprets the currently displayed entry as 20.8 dBmV. If the currently selected reference level units had been dBm or dBW, the 2714 would have interpreted your entry correctly when you pressed the terminator key.

The RF attenuation is reduced to 2 dB and the reference level readout indicates the desired 20.8 dBmV. For the parameters established for this example, this entry method enabled you to specify a reference level that could not be achieved with the arrow keys unless you switched to the FINE mode. You can also enter fractional reference levels to the nearest 0.1 dB with this method.

The spectrum analyzer is still in the MAX SPAN mode, which means that the harmonics of the calibrator signal are barely more than one half division apart. Spread them out by reducing the span/division. As in the case of the reference level, the spectrum analyzer provides two direct entry methods.

Reduce the span to 50 MHz/division by pressing **[↵]** to the right of **[SPAN/DIV]** twice. Notice that the readout now indicates 50 MHz/, and the harmonics are two divisions apart.

### Searching For Signals

900.0MHz	(AUTO SWEEP)	ATTN 50DB
68.8DBMV		VF WIDE
180MHz/MAX		10 DB/
5MHz RBW(AUTO)		

The 2714 provides a signal search feature that enables you to detect signal peaks over a wide frequency range while still using a narrow span and/or resolution BW. The 2714 sequentially implements a series of searches using the marker peak find capability and the span and resolution BW that you specify using the Signal Search menu. Each search range is equal to 10 times the specified span/div, but each search range except the first overlaps the previous range by one division. The first search starts at the beginning frequency and the last stops at, or overlaps, the end frequency as indicated in Figure 7-10. Although the last search range may overlap the end frequency, no signals are reported above the end frequency. A verification process looks at the entire range twice and reports only those signals which are present both times.

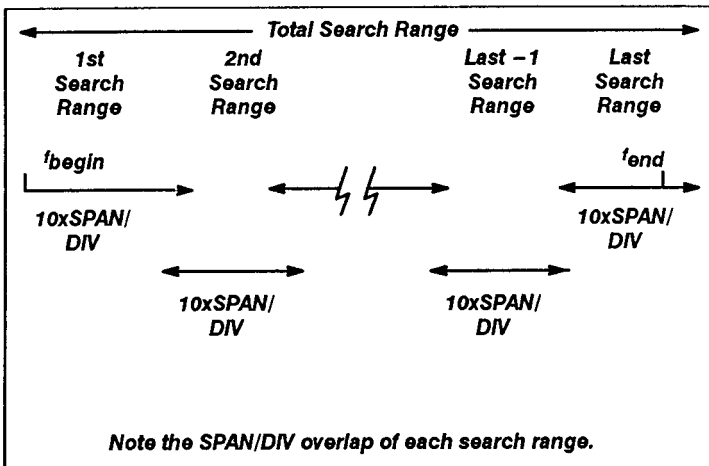

Figure 7-10: The SIGNAL SEARCH Frequency Range

However, suppose that you want to view just a single harmonic and the 30 MHz band to either side of it. You can do this by setting the span to 6 MHz/division. This is not a value obtainable with the arrow keys, but you can get it in the immediate entry mode.

To set the span/division to a predetermined value, first press **[SPAN/DIV]** to place span in the immediate entry mode. Notice that the abbreviation SPAN appears at the left center of the screen.

The SPAN indicator tells you that you can enter the span/div directly from the keypad. This is done by keying in a permissible value followed by an appropriate terminator key.

To set the span/division to 6 MHz, press **[6]**. Any number you type appears on screen to the right of SPAN. If you make a mistake, you can correct it by repeatedly pressing **[BKSP]** (the backspace key) until the incorrect number disappears and then entering the correct value.

After the correct number has been entered, press **[X]**. This key can represent units of MHz, mSEC, or mV. Because you selected an entry mode that requires a frequency, the 2714 correctly interprets the currently displayed entry as 6 MHz. If a time or voltage unit had been required, the 2714 would have interpreted your entry as 6 mSEC or 6 mV, respectively.

The span now is set to 6 MHz, and the ninth harmonic of the calibrator signal is centered on screen at 900 MHz. You may have noticed that the resolution bandwidth changed to 1 MHz. This demonstrates the AUTO resolution bandwidth selection mode of the 2714. The spectrum analyzer reduces its resolution bandwidth as you reduce the span/div, so the resolving power of the instrument automatically increases as you look at the spectrum more closely.

To look at the calibrator signal fundamental, you must change the center frequency. The spectrum analyzer provides three direct methods of doing so, each appropriate under different circumstances.

Press **[↔]** to the right of **[CHAN/FREQ]** twice. Notice that the center frequency readout now indicates approximately 894.0 MHz. The frequency arrow keys change the center or start frequency by the same as the span/div, but you can change the tuning rate. See Selecting the Tuning Increment in Section 7. You could continue pressing **[↔]** until the correct frequency is reached, but this would require a large number of presses.

The C/N reading is the ratio of the signal power at the fixed marker's position to the average noise power at the movable marker position. The noise reading is corrected as indicated in the normalized noise measurement section. Since the noise level measured earlier was approximately  $-44.2$  dBmV and the signal peak is  $18.8$  dBmV, the ratio should be approximately  $63$  dB.

The preamplifier discussed with the **INPUT** menu in this section can be very important when making noise or C/N measurements in broadband networks. For instance, in the U.S., good cable television operating practice requires that the video signal be at least  $0$  dBmV while picture quality requires the noise to be approximately  $43$  dB lower, or approximately  $-43$  dBmV in a  $4$  MHz band. Reset the noise bandwidth to  $4$  MHz. Select **NOISE NORM'D** and notice the measured noise is approximately  $-42$  dBmV. If we connected the 2714 to a cable television tap with a  $0$  dBmV video signal and a  $43$  dB C/N, we would be unable to measure the noise or C/N because the cable noise ( $-43$  dBmV in this example) is below the normal 2714 noise floor.

Using the **INPUT** menu, turn off the calibrator, turn on the preamplifier, and set the RF attenuation to zero. Notice that the 2714 noise floor has been reduced by over  $12$  dB to approximately  $-55$  dBmV, making it possible to measure both noise and C/N on our hypothetical cable.

Turn off the preamp and noise measurement mode.

Re-initialize the 2714 to the factory default power-up settings.

### **NOTE**

*If the 2714 is in the **PEAK** acquisition mode, it reverts to **MAX/MIN** mode whenever the normalized noise or carrier-to-noise features are activated. You can return it to **PEAK** mode by pressing **[DSPL]** [4].*



This method of changing frequency is very useful for scanning relatively small bands. To change by larger amounts, use the immediate entry mode.

To set the center or start frequency to a pre-determined value, press **[CHAN/FREQ]** to place the center or start frequency in the immediate entry mode. Notice that the abbreviation **FREQ** appears at left center of the screen.

The **FREQ** indicator tells you that you can enter the center frequency directly from the keypad by keying in a permissible value followed by an appropriate terminator key.

Set the center frequency to 101 MHz by pressing **[1] [0] [1]**. The numbers you press appear on screen to the right of **FREQ**. If you make a mistake, you can correct it by repeatedly pressing the back-space key until the incorrect number disappears and then entering the correct value.

After the correct number has been entered, press **[X]**. This key can represent units of MHz, mSEC, or mV. Had you wished to set the frequency to 101 kHz, you would have pressed **[Y]**.

This method of changing center or start frequency is most useful when large changes are required or if you know ahead of time exactly what frequency is required.

The span is now set to 6 MHz/ and the fundamental of the calibrator signal is not quite centered on screen. Center the calibrator signal with the **FREQ/MKRS** knob.

Reduce the center or start frequency by turning the **FREQ/MKRS** knob several clicks counterclockwise. Each click reduces the frequency by the currently selected tuning increment (0.02 times the span/div, or 0.12 MHz in this case). The control functions as the "fine" frequency adjustment. Rotating the knob clockwise increases the frequency at the same rate.

Continue turning the knob in either direction until the signal is centered. Your screen should now resemble Figure 3-6.

average noise by pressing [VID FLTR]). It then corrects the measured value for the difference between average and RMS amplitudes. More corrections are added for the effects of log amplification and to account for the equivalent noise bandwidth of the resolution bandwidth filter not being exactly 5 MHz. The resulting noise is then normalized to the specified bandwidth.

Now turn off the markers and the video filter.

### Measuring Carrier-to-Noise Ratios

To demonstrate the carrier-to-noise (C/N) ratio feature of the 2714, we will measure the calibrator-to-2714-noise-floor ratio in a 5 MHz bandwidth. However, you are more likely to measure a carrier peak to system noise ratio, but the technique is the same.

Turn on the calibrator. Then call up the Application menu, and select the Setup Table. Choose item 1, NORM BW FOR C/N, and again enter 5 MHz for the noise bandwidth for the carrier-to-noise (C/N) measurement. Return to the Application menu and select item 1 to turn on the C/N feature.

The spectral display reappears with the fixed marker on top of the 100 MHz signal peak (the 2714 places the fixed marker on the signal peak nearest the center of the screen in the C/N mode). The moveable marker appears 1 division from the left screen edge.

Reposition the moveable marker 50 MHz above the signal.

#### NOTE

*The moveable marker is initially positioned only to clearly separate it from the fixed marker. You must place the noise marker at the frequency where you want the noise measured.*

The first two items in the right on-screen column read approximately as follows.

C/N 63.0DB  
@ 5.0MHZ

The reading may vary slightly. You will also receive the NOISE LEVEL LESS THAN 2DB warning.

Getting Acquainted With Your Instrument

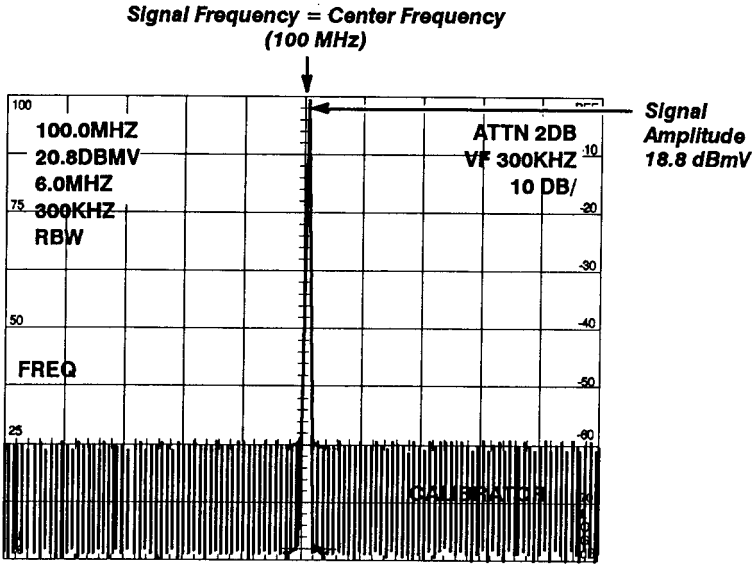

**Figure 3-6: Callbrator Signal Fundamental**

The signal frequency is 100 MHz and the signal peak is 0.2 division below the reference level so its amplitude is 18.8 dBmV as shown in the following equation.

$$20.8 \text{ dBmV ref level} - 0.2 \text{ div} \times 10 \text{ dB/div} = 18.8 \text{ dBmV}$$

Using only the frequency, span, and reference level controls you have verified the basic operation of the 2714, and determined the frequency and amplitude of its calibrator signal.

## Measuring Average Noise

100.0MHz	(AUTO SWEEP)	ATTN 0DB
18.8DBMV		VF WIDE
20.0MHz/ 5MHz RBW (AUTO)		10 DB/

Item 2 of the Applications menu causes the 2714 to measure the average noise at the marker location and normalize it to a specified bandwidth. The default bandwidth is 4 MHz, but you can change it to suit your application. For this example, change the bandwidth to 5 MHz to obtain an approximation of the 2714's noise floor.

Press **[CATV/APPL] [9] [2]**. Enter a value of 5 MHz and return to the Applications menu by pressing **[BKSP]**. Press **[2]** again.

The spectral display reappears and the marker is turned on. The first two items in the right on-screen column read approximately as follows.

N-44.2DBMV  
@ 5.0MHZ

The reading may vary somewhat, and is the average internal noise in a 5 MHz band at the marker frequency. You may also receive the following warning.

NOISE LEVEL LESS THAN 2DB

This is because the 2714 recognizes when the noise it is measuring approaches its own noise floor. It knows that it cannot accurately measure external signals too close to that value.

Ensure that your 2714 is in MAX/MIN display mode, and use the **FREQ/MKRS** knob to reposition the marker at the bottom of the displayed noise. Notice that the noise amplitude readout does not change significantly.

The noise amplitude appears to be approximately half way between the maximum and minimum values of the spectral display. This is because the 2714 does not compute the arithmetic mean of the minimum and maximum values using decibels (that yields an incorrect answer). The display does not change, but you may notice a pause while the 2714 carries out the noise measuring algorithm. First, the 2714 measures the average noise power in ZERO SPAN using a narrow bandwidth video filter (see a better approximation of the



# Operation Summary

number of dB using the Application menu Setup Table. The difference between the frequency points is the bandwidth. Optimum resolution is obtained by spreading the signal across as large a portion of the screen as possible (resolution is essentially plus or minus one frequency cell or 1/512 of the total span in PEAK acquisition mode).

To measure signal bandwidths, first change the resolution BW to 300 kHz. This provides a simulated signal several divisions wide and equal to the width of the resolution BW filter.

Press **[APPL]**. Item 0 indicates BANDWIDTH MODE @ -3 DB, which means that by selecting this item, the 2714 will measure the bandwidth of a displayed signal at points 3 dB down from its peak amplitude.

If you wish to measure the bandwidth at another point, select item 9, SETUP TABLE, from the Applications menu to change the number of dBs down from the peak at which the bandwidth is measured. Choose item 0 from the Setup Table and, following the prompt, enter a value of -6 dB by pressing **[6] [Z]**.

To implement BANDWIDTH MODE, press **[BKSP]** to return to the Application menu. Then press **[0]**.

The 2714 returns automatically to the spectral display after you press **[0]**. The delta markers have been activated and bracket the calibration signal peak. If the signal peak is not centered, the 2714 selects the peak nearest center screen.

The first two items in the right on-screen column read as follows:

```
BW 300KHZ
@ -6DBC
```

You are measuring the bandwidth of the resolution bandwidth filter. The indicated bandwidth will not be exactly 300 kHz; it will vary slightly about 300 kHz.

Change the span to 10 kHz/division and the resolution bandwidth to 30 kHz. The bandwidth should now read approximately 30 kHz.

The 2714 remains in bandwidth mode until you call up the Applications menu and toggle it off, make an alternate selection, or until you turn off the markers. Turn off bandwidth mode by pressing **[APPL] [0]**.



---

## APPL

100.0MHz	(AUTO SWEEP)	ATTN 2DB
18.8DBMV		VF 30KHz
100.0KHz/ 30KHz RBW (AUTO)		10 DB/ CALIBRATOR

This menu is accessible only when the 2714 is not in the CATV mode. (When the 2714 is in the CATV mode and [CATV/APPL] is pressed, the CATV Measurements pages come up on the screen.) Disable the CATV mode by pressing [CATV/APPL] [8] [0].

The Applications menu automates some routine but time consuming spectral measurements. It enables you to quickly determine the following.

- Signal bandwidths
- Normalized noise amplitudes
- Carrier-to-noise ratios
- Occupied bandwidth
- FM deviation
- Search for signals in a specified frequency range

Most of the items in this menu are toggles that turn the indicated measurement mode on and off. However, you can specify certain measurement parameters using item 9, SETUP TABLE. Because several of the measurement modes make use of the markers, you can also exit from those modes by turning off the markers.

One of the items (SIGNAL SEARCH) enables the 2714 to automatically detect and catalog any signals within a specified frequency range and above a designated threshold. The signal amplitudes and frequencies are measured, and the results can be displayed on screen or, if you have a RS-232 port, sent to a printer.

### Measuring Signal Bandwidths

The 2714 measures signal bandwidth by detecting the signal peak, and then finding the frequency points on the signal spectrum that are a designated number of dB down from the peak. You specify the





# Operation Summary

This section provides an overview of the Spectrum Analyzer display, menus, controls, and connectors. The experienced spectrum analyzer user will find it a handy guide.

---

## Display Screen

The Spectrum Analyzer display consists of a 8 division high by 10 division wide graphical sweep screen with a 16 row by 32 character text screen overlay. In the spectral display mode, both the graphic and text data are normally present, although the text screen can be toggled on and off by pressing **[READOUT]**. In the menu display mode, only the text screen is normally present, but the sweep display can be turned on (see The Spectral Display In Menus in Section 7).

The entire screen area is available for the sweep display, but contents of the text screen are placed in predetermined locations. Figure 4-1 shows the text screen layout used in the spectral display mode. When the optional Display Title line is not used, rows 2–11 and rows 13, 14, and 15 move up one.

Figure 4-2 shows the text screen for the menu display mode. The menu footer area contains prompts, general information, and additional data entries shown below.

- Which key to press to return to the spectral display
- Which key to press to back up one menu level
- Which menu key was pressed to enter this menu
- What data to enter
- Data that has already been entered
- Which terminator key to press

### Activating Minimum Hold

400.0MHz	(AUTO SWEEP)	ATTN 0DB
8.8DBMV		VF WIDE
20.0MHz/ 5MHz RBW (AUTO)		10 DB CALIBRATOR

The following procedure describes how to determine the approximate upper and lower bounds on a spectrum by using the MIN HOLD and MAX HOLD features. While MAX HOLD is accessible by dedicated key, MIN HOLD can be accessed only from the Display menu.

Press **[DSPL]** and select item 9. You will be offered a choice of storage registers for the result of the MIN HOLD process. Press **[W]** to simultaneously start the MIN HOLD process and select the A register for the result (pressing **[X]** or **[Y]** would select the B or C register, respectively, for the result).

This feature is analogous to the MAX HOLD function. Minimum hold compares the amplitude of the current sweep, point for point, with the stored minimum value of previous sweeps. If the current amplitude is less, the current value becomes the new stored minimum.

Now press **[MAX HOLD] [B]** to accumulate the maximum spectrum amplitude in register B. With the A, B, and D registers displayed, you have an upper and lower bound on the real-time signal in D. As time passes, you will notice that the upper and lower bounds no longer change, because the probability of new random spectral peaks exceeding those already observed becomes very small.

Turn off the minimum hold feature by selecting item 9 again; reselecting MIN HOLD when it is already on toggles the feature off. Clear and turn off the A and B registers and the maximum hold feature.

## Operation Summary

LINE #	SCREEN CONTENT
1	Display Title (optional)
2	Center Freq/Start Freq                      RF Atten/Mkr Freq/Counter Freq
3	Reference Level                                      Vid Fitr BW/Marker amplitude*
4	Horizontal Scale    "TRKG" Indicator                      Vert Scale*
5	Resolution BW                                      Blank/TV Channel/Video Line
6	"UNCAL" Indicator                                      Single Sweep Messages
7	Error Message
8	User Defined Program Title
9	Displayed Message
10	UDP Status
11	Keypad entry/WFM to Save
12	Real-time Clock Display
13	
14	
15	"CALIBRATOR" Indicator
16	"WARMUP TIME 15 MIN" Message/GPIB & RS-232 Status

Figure 4-1: Layout of the Text Screen In the Spectral Display Mode

LINE #	SCREEN CONTENT
1	Menu Title
2	
3	Up To 10
4	Items (0-9) Displayed
5	Here
6	:
7	:
8	:
9	:
10	:
11	:
12	:
13	Error Message
14	Data Entry
15	Footer area containing prompts
16	general information, and data entries.

Figure 4-2: Layout of the Text Screen In the Menu Display Mode

\*May also contain C/N, NOISE NORM'D, BW, & OBW results.

Enter a new value of 23.8 dBmV for the display line; the alarm should stop because all signals are now below the limit. Press [DSPL] [8] and again select item 4.

The status indicator changes to UNDER. The display line has now changed to a lower limit; the alarm will sound when all signals on screen are under the limit. Press [DSPL] to return to the spectral display. The alarm should be sounding.

Select the LIMIT DETECTOR once again. The status indicator changes to OVER-UNDER. The display line becomes an upper limit and the threshold set using the [MKR/FREQ] [0] becomes a lower limit.

Press [DSPL] to return to the spectral display. The limits are indicated by the broken horizontal line. If signals are within the limits, no alarm sounds. The alarm will sound if all signals fall below the lower limit or if one signal exceeds the upper limit.

The limit detecting features are very useful for go/no-go or yes/no type tests. They are especially useful for doing vehicular leakage surveys of cable television facilities. Set the display line to the desired number of dB $\mu$ V/m, and when the alarm sounds, note the location and magnitude (using the marker readout) of the leak for later investigation and correction.

Further, the display line/limit detector feature converts the user-definable command WAIT FOR END OF SWEEP to a WAIT FOR LIMIT command (see USER DEF at the end of this section). This is a handy way to halt the execution of a user-defined routine until the alarm condition has been satisfied.

If you change the reference level while using the display line/limit detector feature, the line changes position on screen to track the new reference level. Press [  $\blacktriangledown$  ] next to [REF LEVEL] to observe this. However, the line cannot be moved off screen. Continue pressing [  $\blacktriangledown$  ] until the line reaches the top of the screen. You will receive the message DISPLAY LINE OUT OF RANGE.

Lower the line and the message will disappear.

Now turn off the limit detector by selecting LIMIT DETECTOR one more time, and turn off the line by toggling item 1 from the DISPLAY LINE menu.

## Connectors, Controls, and Menus

Most of the Spectrum Analyzer front-panel controls are located in function blocks that are denoted by their borders or background colors. Each block contains related controls. The central gray-colored block contains the fundamental channel, center (or start) frequency, span, and reference level controls. For convenience, one function block is dedicated exclusively to menu display. The control panel and its major functional areas are shown in Figures 4-3 through 4-8. Section 5 contains detailed discussions of the controls.

Trace alignment controls and various input/output connectors are located at the rear panel. Figure 4-9 shows the Spectrum Analyzer rear panel and its connectors. The alignment controls are discussed at the end of Section 5 under Miscellaneous Controls, and the connector terminations are described in Section 8, *External Input and Output*.

The menus are shown in Tables 4-1 through 4-8. Some menu items are not present because they either are not available at the current menu level, are intended primarily for factory calibration and troubleshooting, or they apply to instrument options not currently installed.

A brief description of the function of each of the listed menu selections is given. The functions of the menu selections are discussed in greater detail in Section 7, *The Menus*.

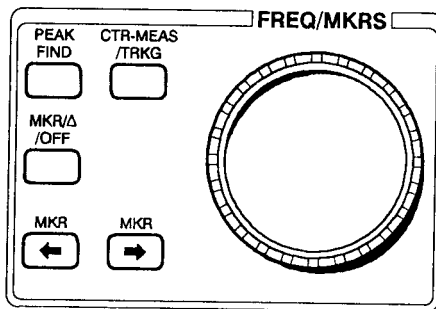

Figure 4-3: The Frequency/Marker Function Block

## The Display Line and Limit Detector

100.0MHz	(AUTO SWEEP)	ATTN 2DB
18.8DBMV		VF WIDE
50.0MHz/		10 DB/
5MHz RBW (AUTO)		CALBRATOR

The 2714 provides a convenient method to determine whether a signal peak is higher or lower than some particular level, or whether it falls within a specified range. The DISPLAY LINE feature displays a horizontal line at the level you specify. You can visually compare signal amplitudes to the line or set the 2714 to sound an alarm if a signal crosses the line.

To see the DISPLAY LINE feature in action, press **[DSPL] [8]**, and select item 2, VALUE ENTRY. Enter  $-2.2$  dBmV by pressing **[2] [•] [0] [W]**.

The 2714 reverts automatically to the spectral display that now contains a horizontal line two divisions down ( $-2.2$  dBmV). You will notice the A register red LED is lit. When you display the line, you cannot display the contents of the A register. Data stored in A are not destroyed, but you cannot see them until you turn off the line.

There is another way to set the level of the line. Turn on the marker and set it at the peak of the calibration signal third harmonic. Press **[DSPL] [8]** again and select item 3, DISPLAY LINE TO MARKER. The spectral display reappears with a horizontal line at the marker position. This provides a convenient way to identify all signals greater or less than another signal. If the marker is not turned on when item 3 is selected, you receive an error message.

Press **[DSPL] [8]** again and select item 4, LIMIT DETECTOR. The end-of-line status indicator changes to OVER; the display line has been made an upper limit. If an on-screen signal goes over the limit, the audio alarm sounds.

Press **[DSPL]** to return to the spectral display. The alarm should be sounding. When the limit detector and the display line are both selected, the marker automatically turns on and moves to the highest signal peak on screen. This feature enables you to quickly read the amplitude of the largest signal after the alarm alerts you that the limit has been exceeded.

### FREQ/MKRS

In the normal spectral display mode, the knob changes the center, or start, frequency by .02 of the span/div per click. In programmed or tabular tuning modes frequency is changed by the designated tuning increment per click. In ZERO SPAN frequency is changed by a percent of the resolution BW per click (see Selecting the Tuning Increment in Section 7.) In other modes, the knob may control marker horizontal position or video line number.

### CTR-MEAS/TRKG

One press initiates a center measure. The frequency of the signal nearest center screen (or nearest the marker, if active) is measured and made the new center frequency. Signal frequency and amplitude are displayed at the upper right of the screen. Two quick presses enter the signal track mode (continuously repeated center measures, enabling a drifting signal to be tracked); signal frequency readout is optional in this mode and is enabled by pressing [MKR/FREQ] [9] [1]. A third press returns to normal operation.

### PEAK FIND

The marker is moved to the highest on-screen signal peak (turns the marker on if it is not active). Signals must be above the detection threshold (see Setting the Signal Threshold in Section 7).

### MKR/ $\Delta$ /OFF

The first press turns on a single marker at center screen; its position is controllable with the FREQ/MKRS knob. A second press fixes the position of the first marker and turns on a second marker (delta marker mode); its position is controllable with the FREQ/MKRS knob. A third press turns off both markers.

### MKR [ $\blacktriangleleft$ ] [ $\blacktriangleright$ ] Keys

Each key, respectively, jumps the moveable marker from its current position to the next on-screen signal peak to the left or right. Signals must be above the detection threshold (see Setting the Signal Threshold in Section 7).

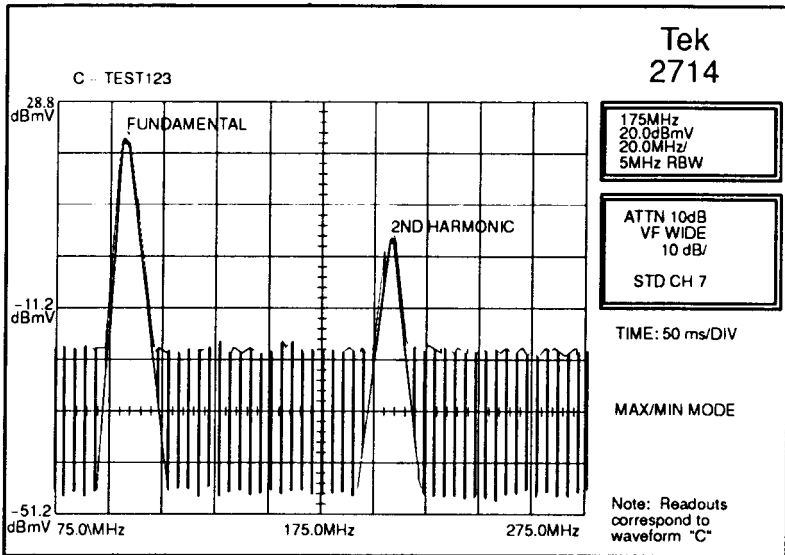

Figure 7-9: 2714 Plot With Title and Plot Labels

## Turning Graticule Illumination On and Off

Item 6 on the Display menu is a simple toggle that turns the graticule illumination on and off. Press [DSPL] [6] several times to see the graticule illumination change states.

## Displaying an External Source

Item 7, DISPLAY SOURCE, in the Display menu enables you to substitute an external, low-pass signal for the normally displayed spectrum. The signal must be input to the 2714 on pin 1 of the rear panel Accessory Connector J103, and must be in the range of 0 to 1.4 V with a 3 dB bandwidth of 50 kHz or less. DISPLAY STORAGE, VERT SCALE 10/5/1, SWEEP RATE, and some VID FLTR selections (10 Hz, 1 kHz, 10 kHz, 100 kHz) remain active and can be used to process the external signal. Refer to the Accessory Connector discussion in Section 8 for additional details.



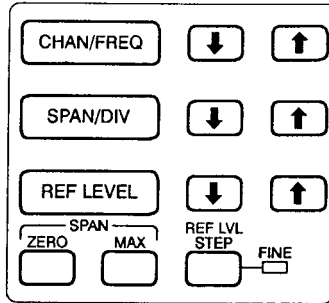

Figure 4-4: Fundamental Analyzer Controls

## CHAN/FREQ

Selects the channel number immediate entry mode when CATV mode is active. CHAN appears on the screen at left center. Enter the desired channel from the keypad; terminate with **[W]**. In non-CATV mode, it selects the center, or start, frequency for immediate entry mode. FREQ appears on the screen at left center. Enter the desired frequency from the keypad; terminate with **[Hz]**, **[kHz]**, **[MHz]**, or **[GHz]** key.

Range: 0 Hz to 1.8 GHz.

## SPAN/DIV

Selects the span per division for the immediate entry mode. SPAN appears on the screen at left center. Enter the desired span/division from the keypad; terminate with **[Hz]**, **[kHz]**, **[MHz]**, or **[GHz]** key.

Range: 1 kHz to 180 MHz

## REF LEVEL

Selects the reference level for the immediate entry mode. REFL appears on the screen at left center. Enter the desired reference level from the keypad; terminate with **[+dBx]** or **[-dBx]** key.

Range: +68.8 to -21.2 dBmV (or equivalent in other units)

## The Menu

Press **[W]** to begin editing. Move the cursor one division to the right of center screen and two divisions down from the reference level. Enter the characters 2ND HARMONIC.

Then move the cursor to the peak at the left of the screen and label it FUNDAMENTAL.

The labels denote the calibrator signal and its second harmonic. Press **[X]** to store the label(s). (Pressing **[Z]** exits from the procedure without any changes.)



To make labels appear on your plot, select item 3 from the Title Mode menu. Item 3 is a toggle which turns the labels on and off. Press **[DSPL]** to return to the spectral display.

### **NOTE**

*Labels only appear on the hard copy device, not on the screen.*

See Figure 7-9 for an example of what the plot should look like, and then turn off the title and plot labels.

## REF LEVEL [ ] and [ ] Keys

The arrow buttons increase  or decrease  the FREQUENCY, SPAN/DIV, and REF LEVEL by a specified amount. They are always active in the spectral display mode, even if the parameter is not selected for immediate entry.

CHAN change (CATV mode): changes by one channel in the channel table, skipping the SKIPPED channels

FREQUENCY change: equivalent of 50 knob clicks or 1 major division in the AUTO tuning increment mode, and by the designated tuning increment in other modes

SPAN/DIV change: in a 1–2–5 sequence from 1 kHz to 180 MHz

REF LEVEL change: 1 dB or 10 dB per step depending on REF LVL STEP setting

## ZERO and MAX Keys

Shortcuts, respectively, to the zero span and maximum span settings. The keys are toggles; one press activates the setting, the second returns to the span used prior to the first press.

ZERO SPAN: no frequency sweep, horizontal axis calibrated in time/div, and the display is a time domain representation of the signal at the indicated center, or start, frequency

MAX SPAN: 180 MHz/div (often used to view full input range of 0–1.8 GHz)

## REF LVL STEP

Toggles the amount by which the REF LEVEL arrow keys change the reference level between 1 dB and 10 dB per press. The adjacent FINE indicator is illuminated when 1 dB is selected.

The title can be up to 31 characters on a single line, and you can only title one display at a time. When the title mode is turned on, the left-hand readouts move down one row to accommodate the title, even if the title field is blank. Select item 2 and press **[W]** to begin editing. If the display is already titled, its title appears at the upper left with an underscore cursor beneath the first letter. If the display is untitled, just the cursor appears.

To edit a title, use the **FREQ/MKRS** knob to sequentially select characters; alphanumeric characters appear above the cursor as the knob is turned. Move the cursor left or right with the **MKR [◀]** and **MKR [▶]** buttons. Delete the entire title by pressing **[Y]**.

As an example, create a new title of TEST123. Rotate the knob until the letter T appears. Move the cursor one place to the right by pressing **MKR [▶]**. Rotate the knob until E appears. Continue this process until you have spelled TEST.

You can enter numbers and advance the cursor automatically without rotating the knob by using the numeric keypad. Press **[1] [2] [3]** to complete the title.

Modify the title to suit yourself. When you have finished, press **[X]** to store the result in the display title buffer. You can also exit from the title edit mode without saving the title or any changes by pressing **[Z]**.

To make the title visible on screen or on a plot, toggle item 1, **TITLE MODE**, of the Title Mode menu to ON. Toggling item 1 again turns off the title. Leave the title on, and return to the spectral display. Your title is visible in the upper left corner of the screen.

At this point, the title is associated with the highest priority waveform. Permanently attach it to a waveform C. Save the title in waveform C by pressing **[SAVE ENABLE]** and **[C]**. Now delete the title from the display title buffer by pressing the **[DSPL] [5] [2] [W] [Y]**, and then return to the spectral display. The title is gone, but the readouts are displaced downward one line because **TITLE MODE** is still enabled. Now turn off the D register and turn on C. The title is back; it has become part of the saved waveform in C. The title will vanish from the screen if any register is turned on that contains a current sweep, but will remain in storage register C until waveform C is unsaved with **[SAVE ENABLE] [C]**.

Now select item 4, **PLOT LABELING EDIT**. Editing plot labels works the same as title editing except that the cursor can be moved vertically using any of the up or down arrow keys.

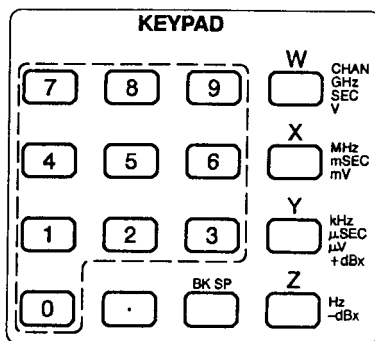

Figure 4-5: The Keypad

### Numeric Keys (0–9)

Numeric keys are used to enter numerical values in the immediate entry mode or in response to menu prompts. They are also used to select the numbered items from menus.

### Terminator Keys (W, X, Y, Z)

The terminator keys signify the end of an entry, and supply the appropriate units for the entry. They are context sensitive; if you press [X], the Spectrum Analyzer automatically interprets it as MHz, mSEC, or mV depending on the parameter being entered.

### Dot Key (•)

The dot key supplies the decimal point in numeric entries, and can be used as a period in label and title entries.

### Backspace Key

The [BKSP] key erases the last character pressed in data entry modes and backs up one menu level when menus are active.

The max/min mode has the advantage of bearing some semblance to the analog signal and readily revealing pulsed versus constant carrier signals. Pulsed signals cause the signal peaks to be filled in.

For now, leave the display in the MAX/MIN mode.

### Adding Titles and Labels

175.0MHz	(AUTO SWEEP)	ATTN 2DB
18.8DBMV		VF WIDE
20.0MHz/		10 DB/
5MHz RBW (AUTO)		CALIBRATOR

If you want to permanently store a spectral display, either by photographing the screen or by plotting the display, you can first title the display. If you are plotting the display, you can also label significant points.

Ensure that only the D register is active, and press [DSPL] [5]. Item 2 reads TITLE MODE EDIT if one or more registers contain a current sweep (as now) or TITLE MODE EDIT WFM X if only saved data are displayed (saving a waveform also saves its title).

In either case, the title to be edited is always associated with the highest priority displayed waveform (see Register Priority in Section 5). This means, for instance, that to create a title for the B waveform, the C and D registers must be turned off; or to edit the title of a saved waveform in the C register, all registers containing a current sweep must be turned off. Although you can edit the title of a saved waveform for display or plotting, only the originally saved waveform title is retained. You can circumvent this restriction by saving the waveform and its new title as part of a stored settings group (see Save and Recall Settings and Displays later in this section); the edited title is then retained as part of the newly saved settings/waveform, and you can delete the original or not as you choose.

When performing a screen plot, the title being edited is attached to the highest priority waveform (even if it has a previously saved title). However, if lower priority saved waveforms exist, their titles are correctly attached to them.

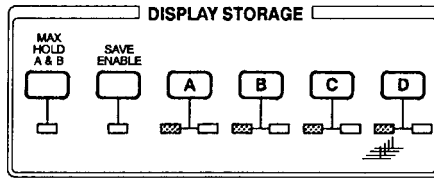

Figure 4-6: Display Register Control

## Register Select and Save Keys (A, B, C, D)

Pressing **[A]**, **[B]**, **[C]**, or **[D]** when **SAVE ENABLE** is not armed turns its respective register on and off for display. When the register is displaying data (saved or current), the red LED to the lower right of the key is lit.

When **SAVE ENABLE** is armed, press **[A]**, **[B]**, or **[C]** to store the current sweep if the register is cleared or clear the register if it contains saved data.

The saving or clearing action occurs whether the register is displaying data or not. The green LED to the lower left of the key lights when the register contains saved data.

Pressing **[D]** when **SAVE ENABLE** is armed toggles the Spectrum Analyzer in and out of waterfall display mode. All registers must first be cleared. Individual sweeps cannot be saved in D.

## SAVE ENABLE

Arms the save (clear) function. Press **[SAVE ENABLE]** and then press the key corresponding to the register to be saved (cleared). The LED below the key lights when **SAVE ENABLE** is armed.

## MAX HOLD A&B

Enables max hold mode. When **MAX HOLD** is enabled, the A and B registers retain the largest signal observed (unless they contain saved waveforms). The LED below the key lights when **MAX HOLD** is active.

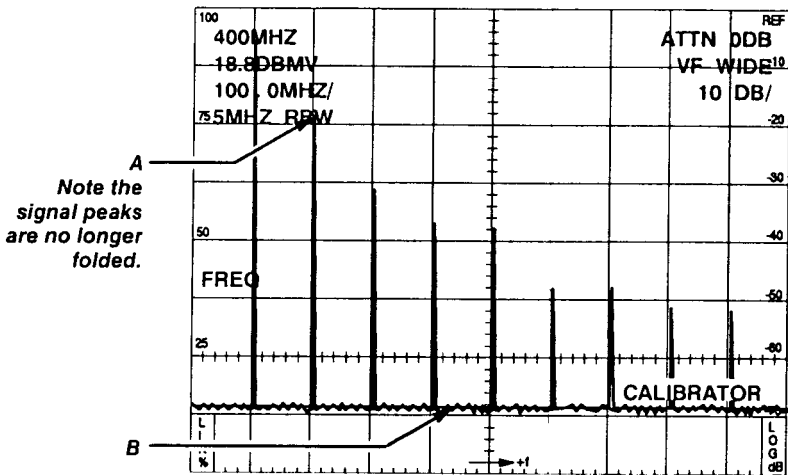

Figure 7-8: B, C Minus A Offset To Top

## Changing Acquisition Mode

100.0MHz	(AUTO SWEEP)	ATTN 2DB
+18.8DBMV		VF WIDE
20.0MHz/		10 DB/
5MHz RBW (AUTO)		CALIBRATOR

Item 4 on the Display menu toggles between MAX/MIN and PEAK signal acquisition modes. To change acquisition modes, press [DSPL] [4]. Quickly toggle back and forth between MAX/MIN and PEAK several times.

Notice that the display PEAK is essentially the top of the MAX/MIN display. The 2714 produces an analog spectrum. In the MAX/MIN acquisition mode, the maximum and minimum amplitudes of this spectrum are alternately sampled at 512 successive points. Plotting the two interleaved sets, of 256 points each, produces the analog-like MAX/MIN spectrum that you see. In the PEAK acquisition mode, the maximum amplitude only is sampled and displayed at all 512 points.



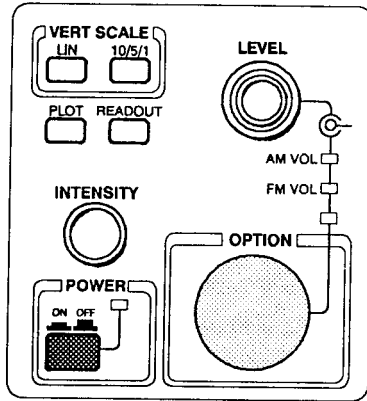

Figure 4-7: Vertical Scale and Other Controls

### 10/5/1

Press repeatedly to cycle the vertical scale in a 10–5–1–10... sequence in LOG (logarithmic) display mode.

### LIN

Toggles the vertical display mode from LOG (logarithmic) to LIN (linear) and back again. Scale factor is controlled by the reference level controls in the LIN mode and by **[10/5/1]** in the LOG mode.

### PLOT

Initiates a screen plot on an optional printer or plotter. Plotter and interface must be correctly configured (see System Configuration in Section 7).

### READOUT

Toggles the on-screen readouts on and off. Use when readouts overlay data, or to eliminate blanking intervals in analog display.

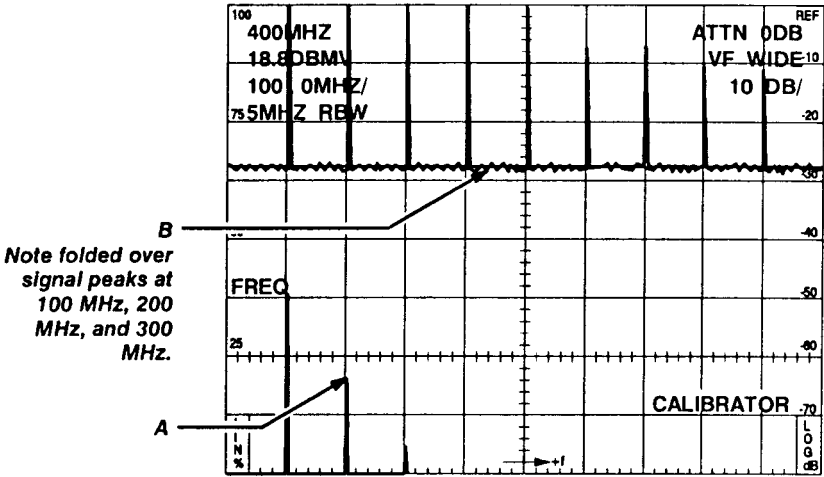

Figure 7-7: B, C Minus A Offset To Center

Press [DSPL] [3]. The waveform is now nearer the bottom of the screen where you can see it more clearly. You have offset the difference between the B and A register waveforms, which is always greater than zero, to the top of the screen (zero difference is at the reference level). However, values above the reference level appear at the bottom of the screen. See Figure 7-8. The points labeled A and B in Figures 7-7 and 7-8 have exactly the same value in each figure. Imagine that the screen curves backwards at the top and bottom until it joins itself, forming a cylinder.

All points of zero difference lie along the joint. Now cut the joint and uncurl the cylinder, allowing it to become a flat screen again. Both the top and bottom of the screen represent zero difference, with negative signal peaks descending from the top of the screen and positive peaks rising from the bottom.

## POWER

Toggles Spectrum Analyzer power on and off. Green LED next to key is illuminated when power is on.

## INTENSITY

Turning the knob clockwise increases CRT brightness.

## LEVEL

The inner knob sets trigger level in INT, EXT, and (AC) LINE trigger modes (as on a conventional oscilloscope), horizontal position in manual scan mode, and picture framing in video monitor mode.

Outer knob controls volume of the AM and FM demodulators.

## AM VOL and FM VOL

Lights when the AM or FM demodulators are active to indicate that the outer knob of the LEVEL control sets the audio volume. See DEMOD in Section 6.

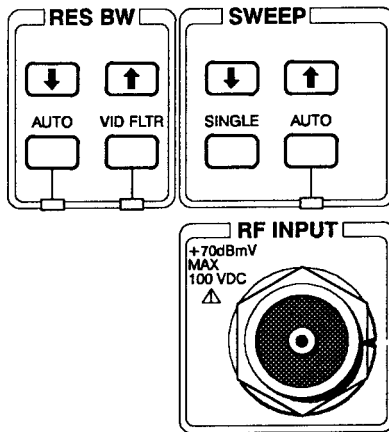

Figure 4-8: Resolution BW and Sweep Control

If the waveform in B gets so much larger than that in A that the result goes off screen, subtract the average MEAN noise from the MAX HOLD signal plus noise. This provides a measure of the maximum signal variations about the mean noise level.

Disable B, C MINUS A mode [DSPL] [2]. Ensure the center frequency is set to 400 MHz and the reference level to 18.8 dBmV. Now turn off the calibrator and store a 24 sweep MEAN average of the noise in register A (you need to overwrite the display currently stored in register A). After the average is complete, turn the calibrator back on and activate MAX HOLD in register B. The resulting traces are shown in Figure 7-6.

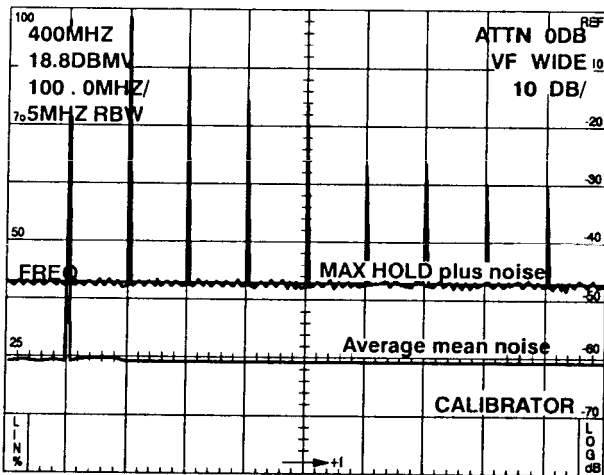

Figure 7-6: Average MEAN Noise and MAX HOLD Signal-Plus-Noise

Turn off the A register and enter the B, C MINUS A mode. The resulting noise floor is approximately two divisions down from the reference level, but some of the calibration signal peaks fold over and point downward. See Figure 7-7.

## VID FLTR

Normally the Spectrum Analyzer smooths the detected signal with a video filter having a bandwidth equal to the resolution bandwidth. The filter bandwidth is indicated in the right-hand readout column. However, pressing **[VID FLTR]** toggles an alternate, automatically selected or user-designated video filter on and off. Its bandwidth replaces the normal video filter readout. You can designate the video filter bandwidth using the UTIL Menu (see Menu-Entered Control Settings in Section 7).

Automatic Selection: 1/100 of the resolution BW

Fixed Range: 3 Hz to 300 kHz and WIDE in a 1–3 sequence

## SINGLE

Press **[SINGLE]** to place the 2714 in a single sweep mode similar to a conventional oscilloscope. SGLSWP MODE appears on the screen. With the 2714's sweep in free run mode (default), press the key again to start a sweep. In other trigger modes, the sweep begins with the first trigger signal following entry into single sweep. SGLSWP ARM appears briefly at the start of each sweep. Pressing **[AUTO]** in the SWEEP function block exits the single sweep mode, but preserves the current auto or manual sweep rate selection mode.

## AUTO

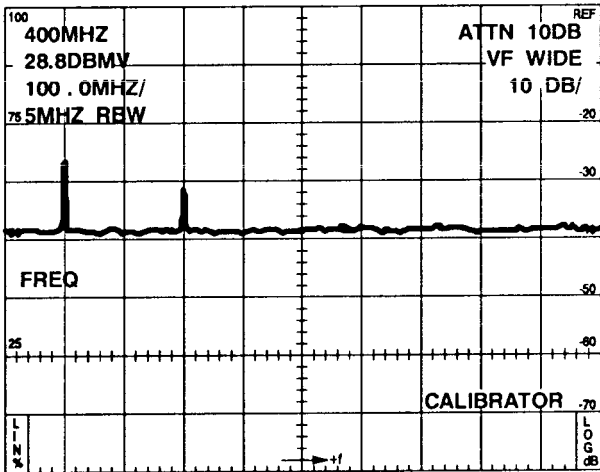
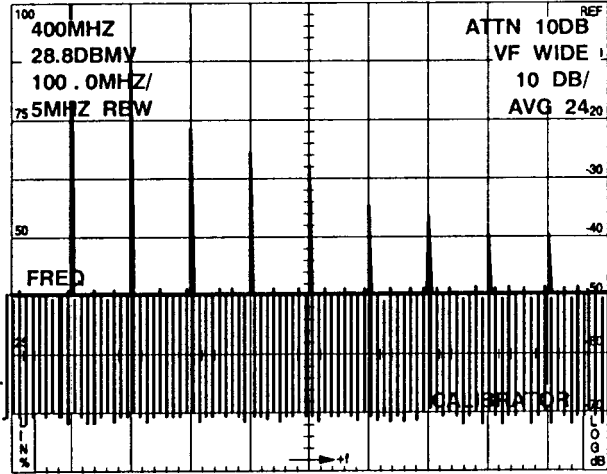

The AUTO keys in the **RES BW** and **SWEEP** function blocks toggle the Spectrum Analyzer into and out of automatic resolution bandwidth and sweep rate selection modes, respectively. **SWEEP [AUTO]** also exits single sweep mode (but preserves the sweep rate selection mode). The LEDs below the keys are lit when the automatic mode is selected. When toggling out of the automatic mode, the resolution BW and sweep rate remain as they were until manually changed. When toggling into the automatic mode, the Spectrum Analyzer selects the resolution bandwidth and sweep rate appropriate to the currently selected span.



**Figure 7-5: Average Signal Plus Noise and Average Signal-Plus-Noise Subtracted from the Current Sweep**

Decrease the reference level 10 dB. The calibration signal peaks appear. Increase the reference level 20 dB. The technique works no matter the direction of the signal change. Reset the reference level to 18.8 dBmV and change the center frequency slightly. Again the calibration signal peaks appear. Any change from the average, either amplitude or frequency, becomes obvious.

[  ] [  ]

The **RES BW** and **SWEEP** arrow keys increase [  ] and decrease [  ] the resolution bandwidth and sweep rate (time/div) in a specified sequence. They are always active in the spectral display mode, but using either disables automatic resolution BW or sweep rate selection, respectively.

**RES BW:** sequences through the installed filters 300 Hz, 1 kHz, 3 kHz, 10 kHz, 30 kHz, 100 kHz, 300 kHz, 1 MHz, 5 MHz

**SWEEP:** follows 1–2–5 sequence from 2 sec/div to 1  $\mu$ sec/div. Rates <100  $\mu$ sec/div are useable only in the analog display mode



*The spectrum analyzer RF signal input is an F-type 75  $\Omega$  connector. **Observe Maximum Input Ratings.***

*Input signal:*

*Maximum Amplitude: < +70 dBmV*

*Maximum DC: 100 Volts*

*Frequency Range: 9 kHz to 1.8 GHz*

## Subtracting Stored Signals

400.0MHz	(AUTO SWEEP)	ATTN 12DB
28.8DBMV		VF WIDE
100.0MHz/		10 DB/
5MHz RBW (AUTO)		CALIBRATOR

The B,C MINUS A feature of the Display menu enables you to subtract a sweep stored in register A from an active sweep in registers B or C. You can use it to flatten a noise spectrum, get rid of unwanted signals, easily detect signal changes, and so forth.

Observe the current sweep, especially the zero-frequency and calibration signal peaks. In your instrument the noise floor may rise slightly with increasing frequency. Perform a 24 sweep MAX/MIN ensemble average and store the result in A. (The average indicator is displayed only when the 2714 is in the non-CATV mode.) Wait until the ensemble is complete. Ensure item 3 of the Display menu reads B,C MINUS A OFFSET TO CENTER.

If it does not, select item 3 once. Then, to activate the B,C MINUS A mode, press **[DSPL] [2]**. Turn on the B register and turn off A and D.

The display now consists of a much-reduced and totally flat noise floor and some intermittent peaks similar to Figure 7-5. The zero-frequency and calibration signal peaks have almost disappeared. You have subtracted the average max/min spectrum stored in the A register from the active sweep in the B register (you can also use the C register), and are displaying the result that consists only of the sweep-by-sweep variations. The vertical center of the screen represents zero amplitude difference between the waveforms.

Waveform subtraction can be used as a sensitive detector of signal changes. Suppose you were trying to measure a weak signal, which you could turn on and off, in the presence of interfering noise and signals. You could turn the signal off, compile the ensemble average and subtract it as above. Then, when you turn the weak signal back on, it would show up because it was not part of the stored average.



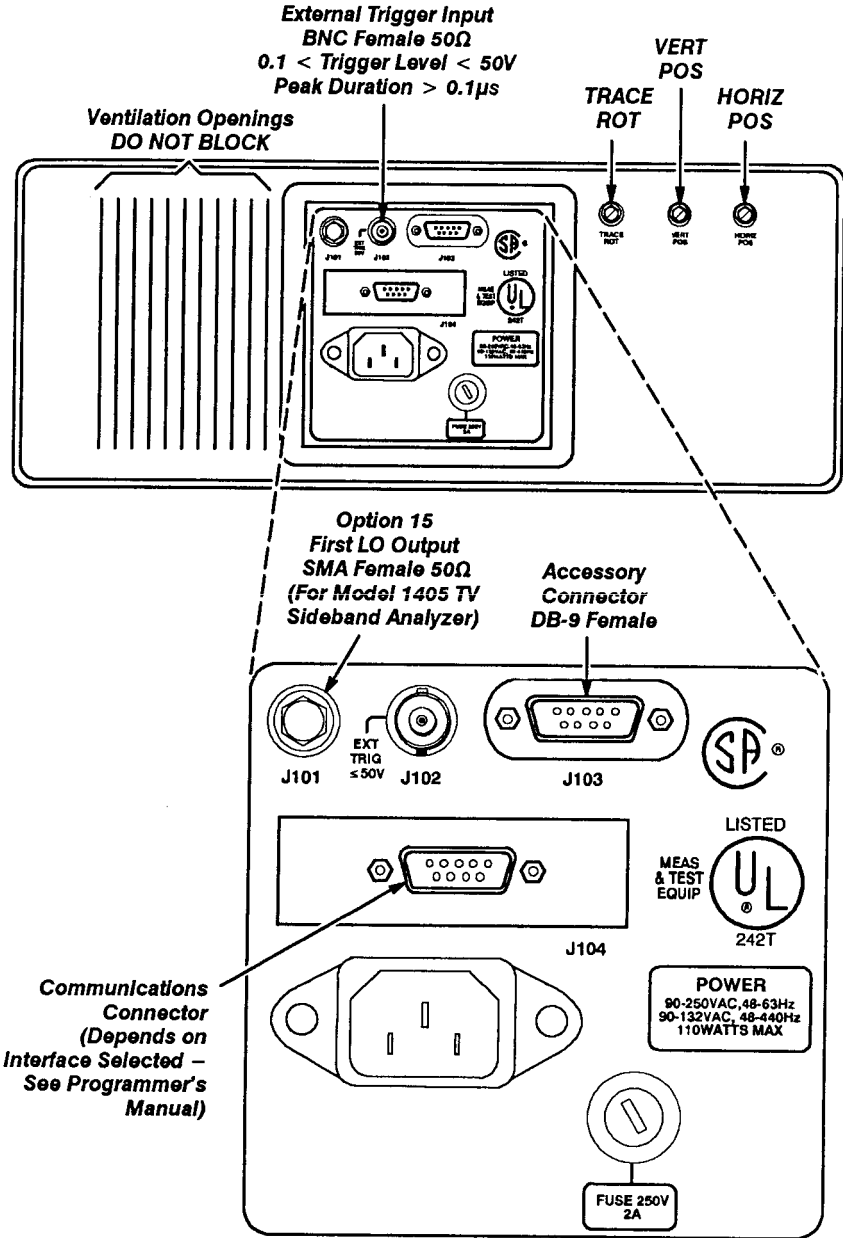

Figure 4-9: The 2714 Back Panel

Press **[DSPL] [1] [3]** to select MAX. Toggle item 8 to register B and select item 1 to start the averaging process. Both status indicators for register B light, the average peak value almost coincides with the upper edge of the MAX/MIN average. Turn off the A register to see the average maximum by itself.

Turn the A register back on. To store the MIN average in register C, press **[DSPL] [1] [5] [8]**, and select item 1 from the ENSEMBLE AVERAGING sub-menu to start.

Both status indicators for register C light. Here, too, we see that the average minimum coincides closely with the lower edge of the MAX/MIN average. In computing the average MIN, the 256 minimum points from each max/min sweep are used.

To store the MEAN value of the spectrum in register A, press **[DSPL] [1] [4] [8]**, and select item 1 to start. At the prompt, press **[W]** to overwrite the previously stored max/min average.

Again, the mean value of the noise appears to be half way between the max and min values. The average MEAN is what you get if you add successive maximum and minimum values in dB from the MAX/MIN display, divide by two, and average the results. The MEAN average is a visual mean, not a true mean, that can be very useful in making weak signals visible.

Turn on the D register to see the current sweep with its visual mean and average maximum and minimum values superimposed. The mean along with the max and min values provide an estimate of the variability of the signal.

The signal peak does not appear to have changed because the calibration signal is essentially constant (little or no variability), so its min, max, and mean amplitude are all about the same. This can be used to advantage. Turn off the A, B, and C registers. Set the reference level to +58.8 dBmV. The calibration signal third harmonic is almost lost in the noise. Now ensemble average the spectrum MEAN values and store the result in A. The mean spectrum leaves little doubt as to the presence or location of the signal peak. Sometimes you can achieve even better results using the average minimum.

Experiment if you like before proceeding, then clear the A, B, and C registers and leave only the D register active.

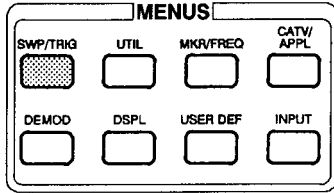

**Table 4-1: The Sweep/Trigger (SWP/TRG) Menu**

Selection	Description
<b>TRIGGER MENU</b>	
<b>0 FREE RUN</b>	Sweep runs continuously
<b>1 INTERNAL</b>	Triggers sweep from input signal
<b>2 EXTERNAL</b>	Triggers sweep from signal at external trigger input
<b>3 LINE</b>	Triggers sweep from AC line
<b>4 TV LINE</b>	Triggers sweep from TV horizontal sync pulse (see setup table)
<b>5 TV FIELD</b>	Triggers sweep from TV vert sync pulse
<b>SWEEP MENU</b>	
<b>6 SWEEP RATE</b>	Enables keypad entry of sweep rate
<b>7 MANUAL SCAN</b>	Toggles manual scan on & off; when on, LEVEL knob controls horizontal position
<b>8 SYNC POLARITY</b>	Toggles video sync pulse polarity between plus and minus
<b>9 SETUP TABLE</b>	
HORIZONTAL LINE TRIGGERING	Determines which sync pulse triggers sweep when TV LINE trigger selected
<b>0 CONTINUOUS</b>	Any sync pulse (line) triggers sweep
<b>1 KNOB SELECTABLE</b>	FREQ/MKRS knob selects line number; number shown on screen; knob also selected by <b>[MKR/FREQ] [2]</b>

Item 8 of the ENSEMBLE AVERAGING sub-menu is a three-way toggle that switches among registers in the sequence A, B, C, A ... . Ensure that register A is clear and then repeatedly press **[8]** until the last character on the line is A.

You can average a fixed number of spectra or choose continuous averaging. Continuous averages are used when the mean value of the signal you are viewing can change slowly with time, when you want to watch a mean value estimate change in real time, or when you simply wish to continuously monitor a process.

If you select a fixed ensemble size, you can average up to 1024 sweeps. The parameter being averaged can be the maximum, minimum, max/min, or mean of the spectral display. Averaging begins when item 1 is selected from the Ensemble Averaging menu and ends when the N<sup>th</sup> sweep has been completed. You can also stop the averaging by selecting item 2 from the menu.

Continuous averaging weights older sweeps so that they have a progressively smaller effect on the average. Each step back in time reduces the impact of a sweep to 90 per cent of its previous value.

The factory default setting is a 16-sweep fixed average. Change the number to 24. Choose item 7 from the Ensemble Averaging menu. Enter 24 by pressing the **[2] [4] [W]**. Item 7 will update as you press **[W]**.

You are now ready to compile a parameter average. There are four choices. Begin with the max/min display by choosing item 6, MAX/MIN, from the Ensemble Averaging menu; you will see the asterisk move down. To start averaging, press **[1]**.

The spectral display reappears and both status indicators for register A light. At the bottom of the right-hand readout column the number of sweeps averaged is displayed (displayed only when the 2714 is in the non-CATV mode). When all 24 sweeps have been included in the average, the readout stops indicating the number unless the A register is the only one turned on. Turn the D register on and off several times and note the difference. Most of the sweep-to-sweep variations in the noise have disappeared.

Repeat the experiment, this time storing the MAX average in register B. In this case, only the 256 maximum values of each max/min sweep are averaged and stored.

**Table 4-1: The Sweep/Trigger (SWP/TRG) Menu (Cont.)**

Selection	Description
<b>SWEEP MENU</b>	
2 KEYPAD ENTERED LINE	Trigger on pulse entered from keypad
3 KEYPAD ENTRY	Enables keypad entry of trigger pulse
4 TV LINE STANDARD	Choose NTSC, PAL, SECAM, or OPEN

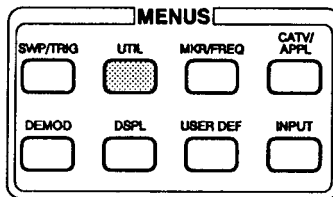

**Table 4-2: The Utility (UTIL) Menu**

Selection	Description
<b>1 STORED SETTINGS/DISPLAYS</b>	Saves & restores settings from a list of up to 37 choices; choices 0 & 1 are reserved; contents of display registers are saved along with settings; settings list consists of 4 with 9 or 10 choices each
0 LAST POWER-DOWN	
1 FACTORY DEFAULT POWER-UP	
2 USER-DEFINED POWER UP	
3 & up user-defined settings	
<b>2 KEYPAD ENTERED SETTINGS</b>	
0 FREQUENCY	Enables keypad entry of center/start frequency
1 REFERENCE LEVEL	Enables keypad entry of reference level
2 SPAN/DIV	Enables keypad entry of span/div
3 RF ATTENUATION	Selects FIXED or AUTO RF attenuation and enables keypad entry of fixed attenuation

## Ensemble Averaging

In general, ensemble averaging techniques are used for the same reason as filters; to enhance the desired-signal-to-noise ratio. Narrow resolution BW or video filters reduce the noise by reducing the 2714's bandwidth. Unfortunately, they also require slower sweep speeds, and in the cases of broadband signals, the filters may limit the signal energy. For these applications, we can use ensemble averaging. However, if ensemble averaging is used with pulsed waveforms without taking special care to synchronize the 2714 to the signal, erroneous measurements result. This is because of the way scanning spectrum analyzers determine the spectrum of pulsed signals. See Tektronix application note 26W-7037-1, *Spectrum Analyzer Fundamentals*, for more information about pulse measurements.

Ensemble averaging computes the average value of some parameter (peak, mean, minimum, etc.) of a number of signal spectra. If the nature of the signal does not change during the period over which the average is compiled, the parameter being averaged rapidly approaches its mean value. This results in an enhancement of the signal-to-noise ratio without reducing the bandwidth or slowing the sweep speed. This does not mean you cannot ensemble average continuous narrowband signals. However, in those cases you can also use video filtering, which may prove faster and more convenient.

The result of the ensemble average is an estimate of the mean value of the parameter being averaged. Successive estimates, or averages, will vary from each other in a random fashion. The larger the number of sweeps averaged, the more accurate an estimate of the spectral characteristic that is obtained.

Select ENSEMBLE AVERAGING by pressing [DSPL] [1].

The Ensemble Averaging menu appears. Items 1 and 2 start and stop the averaging process. The remaining items specify which values to average, how many sweeps to average, and where to store the result.

If you are going to store just the one ensemble average, it makes little difference where you put it. You can use registers A, B, or C, but you cannot store the average in a register that already contains data. Register D is not available, because it always contains the current trace. If you plan to use the stored average as a reference and perhaps intend to subtract it from other spectra, you must store it in register A. Whichever register is used, it must be cleared before you attempt to store new data in it or you will receive an error message.

**Table 4-2: The Utility (UTIL) Menu (Cont.)**

<b>Selection</b>	<b>Description</b>
4 RESOLUTION BW	Selects FIXED or AUTO RBW and enables keypad entry of fixed RBW
0 AUTO	
1 FIXED	
5 VIDEO FILTER	Selects FIXED or AUTO video filter BW and enables keypad entry of fixed video filter BW; only method of manually setting video filter BW
0 AUTO	
1 FIXED	
6 VERTICAL SCALE	Selects vertical scale factor of 1, 5, or 10 dB/div, or linear scale
0 LOG 1 DB/DIV	
1 LOG 5 DB/DIV	
2 LOG 10 DB/DIV	
3 LINEAR	
7 SWEEP RATE	Enables keypad entry of sweep rate
3 NORMALIZATIONS	Enables internal normalization of 2714 frequency or amplitude parameters, or both (ALL PARAMETERS)
0 ALL PARAMETERS	
1 FREQUENCY ONLY	
2 AMPLITUDE ONLY	
<b>4 SYSTEM CONFIGURATION</b>	
0 COMMUNICATION PORT CONFIG	Enables communication port setup
0 GPIB <sup>1</sup>	Select to configure GPIB port
0 STATUS	Toggles GPIB port on and off line
1 GPIB ADDRESS	Enables keypad entry of GPIB address
2 POWER ON SRQ	Toggles generation of service request at power-up on and off

**1 RS-232 or GPIB is present only if the respective port is installed. This selection is not present with Option 08 (RS-232) installed.**

- Title and label displays and plots
- Turn the graticule lights on and off
- Change the source of the display from an internal to an external signal
- Control an on-screen reference line to simplify amplitude measurements and establish alarm thresholds
- Enable and disable the Min Hold feature.

## Changing the Display Mode

You can place the 2714 in the analog display mode by turning off all the display registers using **[A]**, **[B]**, **[C]**, and **[D]** (see Display Storage in Section 5). However, a more convenient method when two or more registers are active, is to use item 0 on the Display menu. Item 0 is a toggle that switches the 2714 between analog and digital display modes.

If the 2714 is in the digital display mode, pressing item 0 turns off all display registers (enters analog display mode).

When in the analog mode, pressing item 0 performs one of two actions.

- If analog mode was entered using item 0, the register configuration prior to entering analog mode is restored
- If analog mode was entered by manually turning off all registers with **[A]**, **[B]**, **[C]**, and **[D]**, the last register turned off is reactivated

Ensure the C and D display registers are active. Save the C register and change the center frequency to 280 MHz so you can distinguish the two active traces.

Press **[DSPL] [0]**. Notice that only the analog signal remains.

Press **[DSPL] [0]** again. Both the saved C digital display and the current D digital display return (the same register configuration that was in use prior to entering the analog mode by selecting item 0).

Turn on the B register, and then turn off all registers in the order D, C, B. Now press **[DSPL] [0]**. Notice that the B register, the last one turned off, is the only one reactivated.

Reset the center frequency to 300 MHz and turn on only the D register.



**Table 4-2: The Utility (UTIL) Menu (Cont.)**

<b>Selection</b>	<b>Description</b>
3 EOI/LF MODE	Selects hardware (EOI) or hardware and software (LF) message termination; all Tektronix instruments support EOI
4 TALK ONLY MODE	Use TALK ONLY when sending data to printer/plotter from 2714 (no controller)
2 RS-232 <sup>2</sup>	Select to configure RS-232 port
0 STATUS	Toggles RS-232 port on and off line
1 BAUD RATE	Steps through baud rates from 110 to 9600 start/stop bits auto-selected
2 DATA BITS	Toggles between 7 and 8
3 PARITY	Cycles NONE, ODD, or EVEN
4 EOL	Chooses message terminator; CR, LF, or CR and LF
5 FLOW CONTROL	Handshaking protocol: HARD(ware), SOFT(ware), or NONE
6 ECHO	Toggles echo response on and off
7 VERBOSE	Toggles VERBOSE on and off; when on, every command receives a response
1 SCREEN PLOT CONFIGURATION	Select to configure communications port for printer/plotter applications
0 COMM PORT	Indicates installed communications port
1 PLOTTER LANGUAGE	Select printer/plotter language; HPGL for plotters, EPSON FX for printers
2 PLOT SPEED	Toggles through a range of plotter speeds from SLOW to FASTEST

**2 RS-232 or GPIB are present only if the respective port is installed. This selection is not present with Option 03 (GPIB) installed.**

status of item 4, **FREQ OFFSET MODE**, changed from OFF to ON PLUS. Select item 4 several times. The status of the frequency offset cycles through OFF – ON PLUS – ON MINUS. Leave the offset set to ON PLUS and return to the spectral display. The center frequency is now indicated as 5450.0 MHz (300 MHz + 5150 MHz offset).

Press [**CTR MEAS/TRKG**]. The counter readout still indicates the true center frequency. Turn on the marker and turn the **MKR/FREQ** knob clockwise. The marker frequency is also increased by 5.15 GHz.

Return to the **MKR/FREQ SETUP TABLE** and toggle item 4 to ON MINUS. Return to the spectral display. The center frequency now reads 4850.0 MHz and the marker reads progressively lower frequencies as it moves to the right.

The frequency axis appears reversed because any time the local oscillator in the frequency converter is above the frequency of the original signal, the output frequencies are reversed. That is, the higher the input signal frequency, the lower the output frequency. This is exactly the process that occurs in C-band block down converters. Therefore, you use ON MINUS when viewing their output. Ku-band converters, on the other hand, have local oscillator frequencies below the input signal frequency, and you use ON PLUS when viewing their output signals.

---

## DSPL

<b>300.0MHz</b>	<b>(AUTO SWEEP)</b>	<b>ATTN 12DB</b>
<b>8.8DBMV</b>		<b>VF WIDE</b>
<b>20.0MHz/</b>		<b>10 DB/</b>
<b>5MHz RBW (AUTO)</b>		<b>CALIBRATOR</b>

The Display menu enables you to change the appearance of the display screen and the signals presented on it. From the Display menu, you can do the following.

- Switch between analog and digital display modes
- Ensemble average spectra
- Directly subtract a stored trace from an active trace
- Switch between MAX/MIN and PEAK signal acquisition modes

**Table 4-2: The Utility (UTIL) Menu (Cont.)**

<b>Selection</b>	<b>Description</b>
3 PLOTS PER PAGE	Toggles between 1 & 4 plots per page
4 PLOT POSITION	Selects page position for each of 4 plots
5 GRATICULE LINES ON PLOT	Toggles graticule lines to be plotted on and off
2 PRINTER CONFIGURATION	Toggles printer output between comm port and screen (CRT)
<b>3 INSTRUMENT CONFIGURATION</b>	
0 AUDIO ALERT	Toggles audio tone on for keyclick only, error only, both, or off
1 MINIMUM SIGNAL SIZE	Enables entry of signal amplitude difference necessary for marker functions
2 WAVEFORM TO PRINTER	Toggles output on and off following each sweep of ASCII- or binary-formatted waveform data to comm port
3 WAVEFORM OUTPUT FORMAT	Toggles comm port output between ASCII & binary
4 PHASELOCK	Selects OFF or AUTO for phaselock
5 FREQUENCY CORRECTIONS	Toggles frequency correction on & off
6 SPECTRAL DSPL IN MENUS	Causes the spectral display to overlay the menus so you can see the display while using the menus
7 SWEEP HOLDOFF	Toggles sweep holdoff between NORMAL & SHORT HOLDOFF
4 REAL-TIME CLOCK SETUP	Enables keypad entry of clock data
5 STORED SETTINGS PROTECT	Prevents/enables the deletion of control settings; when protected, stored settings cannot be deleted but waveforms stored with them can.
6,7 Factory troubleshooting aids	

Return to the Programmed Tuning Increment menu to specify a particular tuning increment. Choose item 3, KEYPAD ENTRY, and enter a value of 7 MHz. The spectral display reappears. Turn the **FREQ/MKRS** knob. The frequency changes by 7 MHz per click, a value not otherwise available. Entering a keypad tuning increment automatically places the 2714 in programmed tuning mode.

There are two ways to turn off any programmed increment, including the keypad entered increment. First, toggle item 8 on the Marker/Frequency menu to read AUTO. This turns off the keypad value and restores automatic selection of the tuning increment. Second, select the programmed tuning increment from the **MKR/FREQ** menu and choose item 4, RETURN TO AUTO from the Programmed Tuning Increment menu. This also turns off the keypad value and restores automatic selection of the tuning increment.

Turn the keypad increment back on by reselecting **PROGRMD TUNING INC** from the **MKR/FREQ** menu, and choosing item 2, **KEYPAD ENTRD INC**.

Now turn off the keypad selected increment.

### Frequency Offsets<sup>1</sup>

300.0MHz	(AUTO SWEEP)	ATTN 12DB
28.8DBMV		VF WIDE
20.0MHz/		10 DB/
5MHz RBW (AUTO)		CALIBRATOR

The Marker/Frequency Setup Table also enables you to offset the on-screen center frequency readout. The center frequency itself is not actually changed, and the counter readout still indicates the true frequency rather than the offset value. This feature is intended to allow the output frequencies of block down converters (LNB's) used in video communications and other industries to be correctly indicated. However, it can be used anytime a signal has been shifted in frequency by a known amount and you want to display its frequency prior to shifting.

If the signal to be viewed is the output of a down converter with a 5.15 GHz local oscillator, call up the **MKR/FREQ SETUP TABLE** and select item 3, **FRQ OFFSET**. Enter an offset of 5.15 GHz (ignore the **CALIBRATOR DOESN'T MATCH READOUT** warning). Notice that the

<sup>1</sup> Not available in CATV mode.

**Table 4-2: The Utility (UTIL) Menu (Cont.)**

<b>Selection</b>	<b>Description</b>
9 INSTALLED OPTIONS DISPLAY	Lists installed options on screen
<b>5 INSTR DIAGNOSTICS/ADJUSTMENTS</b>	
0, 1, 3, 4, 6	Various factory troubleshooting aids
<b>2 MANUAL ADJUSTMENTS</b>	
2 DISPLAY STORAGE CAL	Used with back panel controls to adjust trace alignment
<b>5 SERVICE NORMALIZATIONS</b>	
0 FREQUENCY NORMALIZATIONS	0–2 are used (with external signals or equipment in some cases) to calibrate internal parameters
1 REFERENCE NORMALIZATIONS	
2 AMPLITUDE NORMALIZATIONS	
4 NORMALIZATION VALUES	Displays normalization parameters
5 PRINT ALL NORM VALUES	Sends normalization parameters to printer
6 NORM DEBUG TO PRINTER	Sends messages during normalization to printer
<b>6 SERVICE REQUEST</b>	Generates an SRQ for testing purposes
<b>9 MORE</b>	
0 PRINT READOUTS	Sends on-screen readouts to printer

Reselect item 0 from COUNTER RESOLUTION, and then turn off the TRKG mode.

### Programmed Tuning

300.0MHz	(AUTO SWEEP)	ATTN 12DB
28.8DBMV		VF WIDE
50.0MHz/		10 DB/
5MHz RBW (AUTO)		CALIBRATOR

Choose item 1 from the **MKR/FREQ** menu. The Programmed Tuning Increment menu appears. Programmed tuning increments can be designated by the center or start frequency, the marker or delta-marker frequency, or numeric keypad entries.

The current center frequency is approximately 300 MHz (as would be the start frequency if you placed the 2714 in that mode). Press [0] to select the center frequency as the tuning increment. The spectral display reappears. Turn the **FREQ/MKRS** knob one click clockwise and the frequency is changed 300 MHz. Reset the center frequency to 300 MHz.

Turn on the marker. Position the marker at 150 MHz. Again select item 1 from the **MKR/FREQ** menu. Now choose item 1, currently **MARKER FREQ**, from the Programmed Tuning Increment menu to select the marker frequency as the tuning increment. Turn off the marker and turn the **FREQ/MKRS** knob one click. The frequency should change 150 MHz.

Reset the frequency to approximately 300 MHz. Turn on the marker and position it on the calibration signal fundamental at 100 MHz. Enter the delta-marker mode and place the movable marker on the second harmonic at 200 MHz. From the Programmed Tuning Increment menu, reselect item 1, which now reads **DELTA MKR FREQ**. Turn off the markers and turn the **FREQ/MKRS** knob one click.

The frequency now changes by one harmonic (100 MHz) per click. When making distortion measurements, this is one way to look at positions where harmonics should be present. In fact, anytime your measurements require you to look at multiples of a frequency difference, but you do not want to be bothered with actually entering the frequency, the delta-marker tuning increment mode provides a quick, convenient way of doing it.

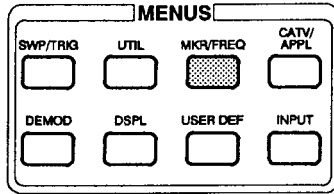

**Table 4-3: The Marker/Frequency (MKR/FREQ) Menu**

Selection	Description
<b>0 THRESHOLD</b>	Enables keypad entry of signal amplified difference for marker and limit detector functions
<b>1 PROGRMD TUNING INC</b> <hr/> 0 CENTER FREQ <hr/> 1 MARKER FREQ <hr/> 2 KEYPAD ENTERED INC <hr/> 3 KEYPAD ENTRY <hr/> 4 RETURN TO AUTO	Selecting PROGRMD TUNING INC determines whether knob increment equals center frequency, current marker frequency, or keypad entered frequency; 4 returns to AUTO selection of tuning increment
<b>2 KNOB FUNCTION</b> <hr/> 0 FREQUENCY <hr/> 1 MARKER <hr/> 2 VIDEO LINE	Toggles knob function from frequency to marker control; VIDEO LINE control is also available if TV Line triggering is active, and knob selectable horizontal line triggering has been chosen with [SWP/TRIG] [9] [1]
<b>3 MARKER TO REFERENCE LEVEL</b>	Changes reference level to the current amplitude of the marker (if active)
<b>4 MOVE MARKER TO NEXT PEAK</b>	Moves marker to next higher or next lower spectral peak
<b>5 TRANSPOSE MARKERS</b>	Interchanges fixed and moveable markers
<b>6 MARKER START/STOP</b>	Makes the display start and stop frequencies equal to the current marker positions

## Setting the Signal Threshold

As earlier discussed, there is a threshold below which the 2714 will not automatically detect signal peaks. Normally the 2714 estimates the peak amplitude of the minimum displayed signal (which usually represents the noise floor) and sets the threshold one division higher. However, when the displayed signal is greater everywhere than the noise, the 2714 sets the threshold in proportion to the signal peaks rather than the noise floor. The threshold is then artificially high and may result in other signals being ignored that rise only slightly above the threshold. Item 0 of the **MKR/FREQ** menu enables you to set the threshold to a fixed amplitude suitable for detecting the signals present in your particular application. The fixed threshold is also handy when you simply want to exclude low-level signals while jumping the marker among high-level peaks.

To set the threshold, choose Item 0 from the **MKR/FREQ** menu and, following the prompts, enter a value of  $-45$  dBm. Press any menu button to return to the spectral display. Using either the **MOVE MARKER** selection from the **MKR/FREQ** menu or the marker arrow keys, attempt to move the marker from peak to peak. It will only jump to the peaks above  $-45$  dBm in amplitude.

Turn off the marker and restore automatic threshold selection by pressing **[MKR/FREQ] [0] [Z]**.

Press any menu button to return to the spectral display.

## Counter Resolution

The 2714 enables you to change the resolution of its built-in counter. It is possible to specify its resolution as 1 kHz or 1 Hz, or to turn off the counter when the Signal Track mode is in use. Be aware that this feature only changes the counter resolution to 1 Hz, not the accuracy.

Press **[MKR/FREQ] [9] [1]**. Under **COUNTER RESOLUTION**, select item 0, **COUNTER OFF WHEN TRKG**. Press **[CTR MEAS/TRKG]** and notice the counter reads out to 1 Hz. Enter the **TRKG** mode and note that there is no counter reading.

Return to **COUNTER RESOLUTION** and select 1 kHz. Notice the counter is now reading in **TRKG** mode. When you select items 1 or 2, the counter reads out to the indicated resolution in either **CTR MEAS** or **TRKG**. Because it takes longer to update the display when the counter is reading out, turning it off speeds up the signal tracking capability.



Table 4-3: The Marker/Frequency (MKR/FREQ) Menu (Cont.)

Selection	Description
<b>7 FREQUENCY START/STOP</b>	Enables keypad entry of display start and stop frequencies
0 FREQ START ENTRY	
1 FREQ STOP ENTRY	
<b>8 TUNING INCREMENT</b>	Toggles between AUTO and PROGRMD tuning increments
<b>9 SETUP TABLE</b>	
0 CENTER/START FREQ	Toggles knob control between start and center frequency
1 COUNTER RESOLUTION 0 COUNTER OFF WHEN TRKG (1 HZ)	
1 1 HZ	Turns off counter readout in signal track mode or sets counter resolution to 1 Hz or 1 kHz
2 1 KHZ	
3 FREQ OFFSET	
4 FREQ OFFSET MODE	Determines whether FREQ OFFSET is ON PLUS, ON MINUS, or OFF (offset value must be entered for ON MINUS to appear)

**Table 7-2: AUTO Tuning Increment**

Span/div	Resolution Bandwidth Filter	Tuning Increment
Zero span	300 Hz, 3 kHz, and 30 kHz	0.033 of RBW
	1 kHz, 10 kHz, 100 kHz, and 1 MHz	0.05 of RBW
	300 kHz	20 kHz
	5 MHz	200 kHz
All Others		0.02 of span/div <sup>1</sup>

Slowly press **[8]** twice.

The tuning increment progresses from AUTO to PROGRMD (programmed) and back to AUTO again. If programmed tuning is selected (see Programmed Tuning later in this section), you can specify whether the center frequency, marker frequency, or keypad entered frequency increment will be used as the tuning increment.

### Center or Start Frequency

Choose item 9 from the Marker/Frequency menu to bring up the setup table. The first item toggles frequency control between center and start frequency. When start frequency is selected, the **FREQ/MKRS** knob controls the frequency at the left edge of the display rather than the frequency at the center. Choose item 0 from the setup table. The spectral display reappears but the center frequency bright spot is now moved to the left edge of the screen, and the frequency readout is preceded by the letters SF (as in SF 300MHz) indicating that the start frequency is now 300 MHz. Some users prefer to run the 2714 in this mode. This feature can be useful for viewing sidebands or performing harmonic distortion measurements.

Toggle back to center frequency control by pressing **[MKR/FREQ] [9] [0]**.

**1** Because of the readout resolution, this appears as 3 and 4 MHz on alternate clicks of the knob in MAX SPAN.

## Operation Summary

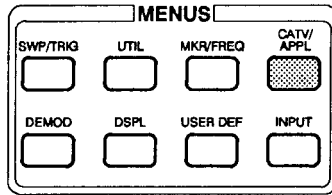

**Table 4-4: The Applications (APPL) Menu**

Selection	Description
<b>8 CATV MEASUREMENT MODE</b>	
<b>CATV MEASUREMENTS (pg 1)</b>	
0 RECENTER CHANNELX	Centers the channel band for the designated channel and adjusts the span/div
<b>1 CARRIER LEVELS</b>	
0 RUN CARRIER LEVELS	Measures visual and aural carrier levels of the selected channel
1 STORE CURRENT RESULTS	Stores the latest carrier levels measured
2 DISPLAY RESULTS	Displays the latest carrier levels measured
3 PRINT CURRENT RESULTS <sup>3</sup>	Prints the latest carrier levels measured
4 PRINT STORED RESULTS <sup>3</sup>	Prints stored CARRIER LEVELS test results
9 LEAVE CARRIER LEVELS	Leaves the CARRIER LEVELS measurement and returns to page 1 of the CATV MEASUREMENTS menu
<b>2 CARRIER SURVEY</b>	
0 RUN CARRIER SURVEY	Measures visual and aural carrier levels of all channels in the selected table
1 STORE CURRENT RESULTS	Stores the latest carrier levels measured

**3 Must be connected to a printer. This is available only when Option 08 is installed.**

times and watch the marker jump to progressively lower peaks. If you try to jump the marker above the highest peak or below the lowest, the message NO SIGNAL FOUND ABOVE THRESHOLD is displayed.

You cannot jump the marker to off-screen signals.

### Marker to the Reference Level

MARKER TO REFERENCE LEVEL is an item on the MKR/FREQ menu that can be used to quickly and easily determine signal amplitudes.

Using any method, (for instance, the MOVE MARKER TO NEXT PEAK feature), place the marker on top of the signal to be measured. In this case, use the calibration signal fundamental. With the marker at the signal peak, press [MKR/FREQ] [3].

The reference level is changed to the signal amplitude to place signals at the reference level to make relative measurements. It is also a convenient method of setting the video carrier to the reference level when using the video monitor option.

When you are finished, turn off the marker.

### NOTE

*Signal amplitudes are always determined most accurately when the signal is within one division of the reference level.*

### Selecting the Tuning Increment

300.0MHZ	(AUTO SWEEP)	ATTN 10DB
28.8DBMV		VF WIDE
50.0MHZ/ 5MHZ RBW (AUTO)		10 DB/ CALIBRATOR

The instrument tuning increment (amount per click by which the tuning knob changes frequency) is 0.02 of the span/division. To change the tuning increment, call up the Marker/Frequency menu. Item 8 is a two-way toggle function indicating that the tuning increment is presently being automatically selected by the 2714. In AUTO mode, the tuning increment is as shown in Table 7-2.

**Table 4-4: The Applications (APPL) Menu (Cont.)**

<b>Selection</b>	<b>Description</b>
2 DISPLAY RESULTS	Displays the latest carrier levels measured
3 PRINT CURRENT RESULTS <sup>3</sup>	Prints the latest carrier levels measured
4 PRINT STORED RESULTS <sup>3</sup>	Prints stored CARRIER SURVEY test results
5 FAST SURVEY	Measures only carrier amplitudes when FAST SURVEY is selected
9 LEAVE CARRIER SURVEY	Leaves the CARRIER SURVEY measurement and returns to page 1 of the CATV MEASUREMENTS menu
<b>3 MODULATION DEPTH</b>	
0 RUN MODULATION DEPTH	Measures depth of modulation in the selected channel
1 STORE CURRENT RESULTS	Stores the latest modulation depth test results
2 DISPLAY RESULTS	Displays the latest modulation depth test results
3 PRINT CURRENT RESULTS <sup>3</sup>	Prints the latest modulation depth test results
4 PRINT STORED RESULTS <sup>3</sup>	Prints stored MODULATION DEPTH test results
9 LEAVE MODULATION DEPTH	Leaves the MODULATION DEPTH measurement and returns to page 1 of the CATV MEASUREMENTS menu
<b>4 AURAL (FM) DEVIATION</b>	
0 RUN AURAL (FM) DEVIATION	Measures FM deviation of the selected channel aural carrier
1 STORE CURRENT RESULTS	Stores the latest FM deviation measured
2 DISPLAY RESULTS	Displays the latest FM deviation measured

**3 Must be connected to a printer. This is available only when Option 08 is installed.**

## The Menus

You can continue this process all the way to 1.8 GHz. Exit from this mode by turning off the markers.

This feature is particularly useful when you want to measure the differences between two or more signals so widely separated in frequency that they do not fit on screen at the span/division at which you wish to view them. If you are already using the Marker/Frequency menu, item 2 also conveniently turns on the marker mode when it is set to MKR.

If you trigger the 2714 with a TV video sync pulse by choosing KNOB SELECTABLE from the Sweep/Trigger menu Setup Table, the Knob Function menu offers another choice: VIDEO LINE. Selecting VIDEO LINE lets you use the FREQ/MKRS knob to control which TV line triggers the sweep. Selecting FREQUENCY or MARKER continues to let you control the center or marker frequency. This feature enables you to conveniently flip between frequency and TV line control. This can be very useful when viewing multiple TV channels. You can select FREQUENCY for changing channels and then to VIDEO LINE for choosing the line number. For a complete explanation of TV LINE trigger mode, see TV Line Trigger later in this section.

### Moving the Marker to the Next Higher or Lower Peak

300.0MHZ	(AUTO SWEEP)	ATTN 10DB
28.8DBMV		VF WIDE
50.0MHZ/		10 DB/
5MHZ RBW (AUTO)		CALIBRATOR

The front-panel controls enable you to move the marker to the next signal peak to the left or right, but the Marker/Frequency menu enables you to jump the marker from peak to peak in ascending order of amplitude, and then jump down again in descending order.

Turn on the single marker and place it in the noise — it does not matter where. Select item 4 from the Marker/Frequency menu and then press **[W]**. The marker is now on top of the lowest of the calibration signal harmonics. Select item 4 and press **[W]** again. The marker is now on top of the second lowest peak. Repeat this process until the marker reaches the highest peak (the fundamental). After the marker is on the highest peak, select item 4 and press **[X]**. Repeat this process several

**Table 4-4: The Applications (APPL) Menu (Cont.)**

<b>Selection</b>	<b>Description</b>
3 PRINT CURRENT RESULTS <sup>3</sup>	Prints the latest FM deviation measured
4 PRINT STORED RESULTS <sup>3</sup>	Prints stored AURAL DEVIATION test results
9 LEAVE AURAL (FM) DEVIATION	Leaves the AURAL DEVIATION measurement and returns to page 1 of the CATV MEASUREMENTS menu
<b>5 CARRIER TO NOISE</b>	
0 RUN CARRIER/NOISE	Measures carrier-to-noise ratios in the selected channel
1 STORE CURRENT RESULTS	Stores the latest carrier-to-noise ratio measured
2 DISPLAY RESULTS	Displays the latest carrier-to-noise ratio measured
3 PRINT CURRENT RESULTS <sup>3</sup>	Prints the latest carrier-to-noise ratio measured
4 PRINT STORED RESULTS <sup>3</sup>	Prints stored CARRIER TO NOISE test results
5 CARRIER/NOISE SETUP	Enables selection of the carrier-to-noise task modes
9 LEAVE CARRIER TO NOISE	Leaves the CARRIER TO NOISE measurement and returns to page 1 of the CATV MEASUREMENTS menu
<b>6 HUM/LFD</b>	
0 RUN HUM/LFD	Measures hum or low frequency disturbance depending on whether the modulating signal is present or not
1 STORE CURRENT RESULTS	Stores the latest HUM/LFD test result
2 DISPLAY RESULTS	Displays the latest HUM/LFD test result
3 PRINT CURRENT RESULTS <sup>3</sup>	Prints the latest HUM/LFD test result

**3 Must be connected to a printer. This is available only when Option 08 is installed.**

old reference is now the movable marker. Move the marker to the 200 MHz peak and note the frequency difference. This completes the example.

Exit from delta-marker mode.

## Changing the Knob Function

100.0MHZ	(AUTO SWEEP)	ATTN 12DB
28.8DBMV		VF WIDE
20.0MHZ/		10 DB/
5MHZ RBW (AUTO)		CALIBRATOR

The knob is normally used to vary the center/start frequency, marker position, or the video line selection.

To see how this feature is used to make frequency difference measurements across the whole range of the 2714, enter the delta-marker mode with both markers at the calibrator signal peak. The following procedure describes how to measure the frequency difference between the calibrator signal and each of its harmonics, but you could use the same procedure to measure any series of signals.

To change the knob function, call up the Marker/Frequency menu and select item 2, KNOB FUNCTION. The Knob Function menu appears. Currently, the knob is controlling the markers, as you would expect in delta-marker mode. Select item 0 from the Knob Function menu to change to frequency control and then press **[MKR/FREQ]**. The spectral display reappears.

However, watch what happens as you rotate the FREQ/MKRS knob several clicks clockwise. Notice how the center frequency increases and the spectrum slides to the left. One marker remains fixed on top of the cal signal peak while the other remains fixed at center scale. Consequently, the difference frequency also increases. Continue turning the knob until the second harmonic approaches center scale. Press **[CTR MEAS/TRKG]**, and the second harmonic is automatically centered. The amplitude and frequency difference between the fundamental and the harmonic are displayed at the top of the right column preceded by DC (delta count). Repeat this procedure for the third harmonic. Notice that although the reference peak (the cal signal fundamental) is now far off-screen to the left, you are still accurately measuring the difference frequency.



**Table 4-4: The Applications (APPL) Menu (Cont.)**

<b>Selection</b>	<b>Description</b>
4 PRINT STORED RESULTS <sup>3</sup>	Prints stored HUM/LFD test results
5 POWER LINE FREQ	Selects hum frequency
9 LEAVE HUM/LFD	Leaves the HUM/LFD measurement and returns to page 1 of the CATV MEASUREMENTS menu
<b>7 FREQUENCY RESPONSE</b>	
0 RUN FREQ RESP	Measures frequency response in the selected range
5 FREQ RESP SETUP	Provides for taking and storing a reference, recalling a stored reference and editing (similar to TITLE MODE EDIT) the current reference title—allows entry of start and stop frequencies
<b>TEST MODES</b>	
0 NO REF	Selects frequency response measurement without a reference
1 *WITH REF	Selects frequency response measurement with a reference
<b>SWEEP RANGE/ REFERENCE ACQUISITION<sup>4</sup></b>	
2 START FREQUENCY	Allows entry of start frequency
3 STOP FREQUENCY	Allows entry of stop frequency
4 USE DEFAULT START/ STOP	Sets start and stop frequencies according to the selected channel table frequency limits
5 ACQUIRE NEW REF- ERENCE	Acquires a frequency response reference

**3** Must be connected to a printer. This is available only when Option 08 is installed.

**4** SWEEP RANGE if item 0 has been selected and REFERENCE ACQUISITION if item 1 has been selected. Items 5 through 7 are shown only when item 1 has been selected. An asterisk following the numerical designator for a selection means that item is selected.

making the start and stop frequencies 175 MHz and 425 MHz respectively. If you make the start frequency greater than the stop frequency, the 2714 enters ZERO SPAN mode tuned to the start frequency.

### Using Markers to Set Start and Stop Frequencies

You can also set the start and stop frequencies with the markers. This method provides a visually intuitive approach to span control, enabling you to designate only that portion of the displayed spectrum that is of particular interest.

Turn on the marker and place it just to the left of the calibration signal harmonic at 300 MHz. Enter the delta-marker mode and place the active marker just to the right of the harmonic at 400 MHz. Select item 6, MARKER START/STOP, from the Marker/Frequency menu.

The spectral display reappears and brackets the calibration signal third and fourth harmonics. The marker start/stop selection automatically adjusts the starting frequency of the display and the span/div so that what is displayed is what was between the markers. If you are not in the delta-marker mode when you select MARKER START/STOP, the 2714 will enter zero span at the current center or marker frequency.

Turn off the markers. Notice that the resolution BW has also changed in response to the changed span/div, because RES BW was in AUTO mode.

### Transposing Markers

300.0MHZ	(AUTO SWEEP)	ATTN 12DB
28.8DBMV		VF WIDE 0
50.0MHZ/ 5MHZ RBW (AUTO)		10 DB/ CALIBRATOR

Suppose you want to measure the difference in frequency between the peaks at 300 MHz and 500 MHz and between 500 MHz and 200 MHz. To do so, enter marker mode, and position the marker on the 300 MHz peak. Enter delta-marker mode and place the active marker on the 500 MHz peak, and the difference is 200 MHz. Select item 5, TRANSPOSE MARKERS, from the Marker/Frequency menu. Turn the FREQ/MKRS knob. The movable marker has become the reference and the

**Table 4-4: The Applications (APPL) Menu (Cont.)**

<b>Selection</b>	<b>Description</b>
6 STORED REFERENCE MENU	Lists up to 10 stored references
7 EDIT CURRENT REFERENCE NAME	Provides for editing of the current reference
9 LEAVE FREQUENCY RESPONSE	Leaves the FREQUENCY RESPONSE measurement and returns to page 1 of the CATV MEASUREMENTS menu
<b>8 CATV MEASUREMENT SETUP</b>	
0 EXIT CATV MEASUREMENT MODE	Leaves CATV measurement mode
1 CHANNEL TABLE	Selects 1 of 10 channel tables
0 *STD	
1 HRC	
2 IRC	
3 through 9	
2 SKIP CHANNEL	Tags channels to be skipped during multiple-channel tests
3 ALL CHANNELS	Ignores skip status of all tagged channels
4 SITE	Allows test site identification entry
5 OPERATOR	Allows technician identification entry
6 REMOVE ALL STORED RESULTS	Removes all CATV test/measurement results stored in memory
<b>9 MORE CATV MEASUREMENTS (page 2)</b>	Displays page 2 of the CATV MEASUREMENTS menu
0 RECENTER CHANNELX	Centers the channel band for the designated channel and adjusts the span/div
1 VIEW MODULATION (FIELD)	Displays one field
2 VIEW MODULATION (LINE)	Displays line 17 (default) or the VITS line specified in the channel table

antenna that matches the  $75 \Omega$  2714 impedance, you should be able to see signals ranging from approximately 2 dB $\mu$ V/m (1.3  $\mu$ V/m) at 55 MHz to 14 dB $\mu$ V/m (5  $\mu$ V/m) at 216 MHz.

If greater sensitivity is required, the following three options are possible.

- Provide an external preamplifier
- Use a higher gain antenna; sensitivity increases directly as antenna gain
- If the signal being measured is narrowband, reduce the RBW to the narrowest setting still capable of passing the signal; for instance, the 3 kHz filter increases sensitivity by a further 20 dB over the 300 kHz filter

---

## MKR/FREQ

100.0MHz	(AUTO SWEEP)	ATTN 12DB
28.8DBMV		VF WIDE
20.0MHz/ 5MHz RBW (AUTO)		10 DB/ CALIBRATOR

With the Marker/Frequency menu you can directly affect the frequency characteristics of the spectral display and control the markers in ways not available from the front panel.

### Setting Start and Stop Frequencies

Perhaps you would prefer to directly specify the beginning and ending frequencies of the display rather than its center frequency and span. The 2714 enables you to do so by pressing **[MKR/FREQ] [7]**.

From the resulting menu, select item 7, FREQUENCY START/STOP. A submenu appears enabling you to specify start and stop frequencies for the spectral display. Choose item 0 and, following the prompt, press **[1] [7] [5] [X]** to specify a start frequency of 175 MHz. Note that the indicated start frequency has changed. Now choose item 1 and enter a value of 425 MHz for the stop frequency. Return to the spectral display by pressing any menu button. The span is 25 MHz/division

Table 4-4: The Applications (APPL) Menu (Cont.)

Selection	Description
4 LISTEN	Enables the FM detector to listen to the selected channel audio
5 CTB/CSO	
0 RUN CTB/CSO	Measures composite third order and second order beat levels in the selected channel
1 STORE CURRENT RESULTS	Stores the latest test results
2 DISPLAY RESULTS	Displays the latest test results
3 PRINT CURRENT RESULTS <sup>3</sup>	Prints the latest test results
4 PRINT STORED RESULTS <sup>3</sup>	Prints stored results for this test
5 CTB/CSO SETUP	
0 INTERACTIVE	Selects Interactive test mode
1 AUTO	Selects automatic test mode
2 AUTO (PAUSE FOR CARRIER OFF)	Selects Auto with Pause (for tuning off the carrier) test modes
3 SINGLE-SWEEP	Selects the single-sweep mode
4 +1.250MHZ <sup>5</sup> (OFFSET)	Allows the user to specify five points (relative to the visual carrier) where tests are made in Auto mode. The test locations table is not available in Interactive Mode.
5 +750.000KHZ <sup>5</sup> (OFFSET)	
6 +0.000HZ <sup>5</sup> (OFFSET)	
7 -750.000KHZ <sup>5</sup> (OFFSET)	
8 -1.250MHZ <sup>5</sup> (OFFSET)	
6 DIGITAL/ANALOG	Toggles between digital and analog displays
9 LEAVE CTB/CSO	Leaves the CTB/CSO test and returns to page 2 of the CATV MEASUREMENTS menu

**3** Must be connected to a printer. This is available only when Option 08 is installed.

**5** Default values.

8. Naming antennas is not required, but names can provide quick reminders of the purpose of each antenna. To name an antenna, select item 1, TITLE EDIT. Press **[W]** to begin editing. If an old antenna table is being modified, its name appears at the upper left with an underscore cursor beneath the first letter. If the antenna table is new, only the cursor appears. You can delete the old name entirely by pressing **[Y]**. Pressing **[Z]** aborts the title editing process without changes. To change the title, turn the FREQ/MKRS knob to select letters. Use **MKR [↗]** or **MKR [↘]** to move the cursor back and forth. When the title is complete, press **[X]**.
9. To store the antenna data and title, select item 2, STORE, and choose any unused antenna number. The new or modified antenna table will be stored under that number. Its name is displayed adjacent to the number. If you do not name the antenna, it is given a name of ANTENNA #. If all five antenna tables are already in use, you will have to delete an existing antenna before you can store the new or modified table. For instance, suppose you have modified an existing antenna table and wish to store the modified version in the place of the original table using the same antenna name. Even though the name and location are the same, you must first delete the original antenna table. Deleting the original antenna from the antenna list does not delete the edited version in the local buffer. After you delete the original, store the edited version in the original location.
10. You can print the antenna data if your 2714 is equipped with an optional communications port and appropriate printer. To print the antenna data, select item 5, PRINT, from EDIT ANTENNA TABLE and simply choose the antenna data you want to print from the resulting list.
11. The DISPLAY LINE feature (**[DSPL] [8]**) can be used with the dB $\mu$ V/m for making vehicular surveys of leakage from cable TV installations, or in other applications where an audible alert is useful whenever a signal amplitude crosses a preset threshold. To sound a high-level alert whenever the measured RF field strength exceeds the threshold, set the DISPLAY LINE at the desired threshold. See The Display Line and Limit Detector in this section for complete details.

To look for very low amplitude RF energy, turn on the 2714's preamplifier. Actual sensitivity depends on the antenna used and losses in cabling and coupling to the 2714. With minimum cable losses and an

**Table 4-4: The Applications (APPL) Menu (Cont.)**

<b>Selection</b>	<b>Description</b>
<b>6 CROSS MODULATION</b>	
0 RUN CROSS MODULATION	Measures CROSS MODULATION in the selected channel
1 STORE CURRENT RESULTS	Stores the latest test results
2 DISPLAY RESULTS	Displays the latest test results
3 PRINT CURRENT RESULTS <sup>3</sup>	Prints the latest test results
4 PRINT STORED RESULTS <sup>3</sup>	Prints stored test results for this test
9 LEAVE CROSS MODULATION	Leaves the CROSS MODULATION test and returns to page 2 of the CATV MEASUREMENTS menu
<b>7 IN-CHANNEL RESPONSE</b>	
0 RUN IN-CHAN RESP	Measures frequency response in the selected channel
1 STORE CURRENT RESULTS	Stores the latest test results
2 DISPLAY RESULTS	Displays the latest test results
3 PRINT CURRENT RESULTS <sup>3</sup>	Prints the latest test results
4 PRINT STORED RESULTS <sup>3</sup>	Prints stored results for the test
<b>5 IN-CHAN RESP SETUP</b>	
0 INTERACTIVE	Selects interactive test mode
1 *AUTO (WITH PAUSE FOR TEST SIGNAL)	Selects Auto with Pause (for enabling the test signal) test mode
2 -0.50MHZ	Allows the user to specify up to six points (relative to the visual carrier) where tests are made in Auto mode. The test locations are not available in Interactive mode. The values shown are default test locations.
3 +0.50MHZ	
4 +1.00MHZ	
5 +2.00MHZ	
6 +3.00MHZ	
7 +3.58MHZ	

**3** Must be connected to a printer. This is available only when Option 08 is installed.

6. After you have loaded an old antenna table or established the frequency range and calibration distance for a new one, select item 0 from EDIT ANTENNA TABLE. A list of frequencies beginning with the start frequency and ending with the stop frequency appears. The numbers to the right of the frequencies are the antenna factors, or K-factors. When creating antenna tables, the 2714 supplies default values of zero for the K-factors. To begin changing the antenna factors, press **[W]** and enter the appropriate factor. The asterisk indicates which factor is to be edited. After you enter a value for a factor, the asterisk moves to the next frequency. If you do not want to change the antenna factor at the indicated frequency, turn the **FREQ/MKRS** knob to move the asterisk to the desired frequency.

For instance, suppose an antenna manufacturer specifies the antenna factors for his antenna as follows.

f	k	f	k	f	k
—	—	55.0	2.7	60.0	3.5
51.0	2.1	56.0	2.9	61.0	3.6
52.0	2.3	57.0	3.0	62.0	3.8
53.0	2.4	58.0	3.2	63.0	3.9
54.0	2.5	59.0	3.3	—	—

Then to make measurements from 55 to 60 MHz, the entries in the antenna table should look like this:

```

1> 55.000000 : 2.7
2> 56.000000 : 2.9
3> 57.000000 : 3.0
4> 58.000000 : 3.2
5> 59.000000 : 3.3
6> 60.000000 : 3.5

```

7. If you are creating a new antenna table, press **[Z]** to exit (return to EDIT ANTENNA TABLE) after the last entry has been completed. If you are editing an existing table, press **[W]** after your last entry. Then press **[Z]** to return to EDIT ANTENNA TABLE.



**Table 4-4: The Applications (APPL) Menu (Cont.)**

<b>Selection</b>	<b>Description</b>
<b>8 USE DEFAULT TEST LOCATIONS</b>	Uses the default test locations (values shown above) for the test
<b>9 LEAVE IN-CHAN RESP</b>	Leaves the IN-CHANNEL RESPONSE measurement and returns to Page 1 of the CATV MEASUREMENTS menu
<b>9 MORE</b>	Returns to page 1 of the CATV MEASUREMENTS menu
<b>0 BANDWIDTH MODE</b>	Determines BW of a spectral peak at points a designated number of dB down
<b>1 CARRIER TO NOISE</b>	Measures carrier-to-noise ratio at points indicated by markers
<b>2 NOISE NORM'D</b>	Measures noise in normalized bandwidth at point indicated by marker
<b>3 SIGNAL SEARCH MENU</b>	Enables entry of signal search parameters
<b>0 BEGIN FREQ</b>	Frequency at which search begins
<b>1 END FREQ</b>	Frequency at which search ends
<b>2 START TEST</b>	Starts automated signal search
<b>3 DISPLAY RESULTS</b>	Sends results to printer or screen; use [UTIL] [4] [2] to select designation
<b>4 OCCUPIED BW</b>	Determines the bandwidth that contains a specified % of the signal energy
<b>7 FM DEVIATION MODE</b>	Displays instantaneous FM deviation vertically at 10, 5, or 1 kHz/div
<b>8 CATV MEASUREMENT MODE</b>	
<b>9 SETUP TABLE</b>	
<b>0 DB DOWN OF BW MODE</b>	Enables keypad entry of dB down for bandwidth mode
<b>1 NORM BW FOR C/N</b>	Enables keypad entry of C/N measurements for normalized bandwidth

## The Menus

all editing takes place in the local buffer or editing buffer using the EDIT ANTENNA TABLE selection from the DBUV/M SETUP on the INPUT menu. New antenna data are written directly to the buffer prior to permanent storage; old data are loaded into the buffer prior to editing and re-storage. If you wish to enter new antenna data or change old data, use the following procedure.

1. Select DBUV/M SETUP from the INPUT menu, and then select item 0, EDIT ANTENNA TABLE.
2. To create a new antenna entry, select item 6, ANTENNA SETUP. Enter the start, stop, and frequency steps at which measurements will be made. Enter the reference distance. The reference distance is the distance to which you want the field strength referred. For maximum accuracy your antenna should be calibrated at the reference distance and your measurement made at that distance. However, if you require another distance, enter it here. For instance, if you are making measurements at 10 meters, but want the field strength at 3 meters, then enter 3 meters. Press the back arrow key to return to EDIT ANTENNA TABLE. Item 0 will continue to indicate EMPTY at the end of the line because there are still no antenna factors in the local buffer.
3. To edit an old antenna entry, select item 3, LOAD, from the EDIT ANTENNA TABLE and choose the antenna you want to edit. If there is already something in the local buffer, you are given the choice:

**W = OVERWRITE LOCAL BUFFER**

**Z = ABORT**

4. If you need the data currently in the local buffer, abort the procedure and store it. Otherwise, select W. After the antenna is loaded, its name (if it has one) or number is shown at the end of the first line of EDIT ANTENNA TABLE indicating that the antenna factors for that antenna have been loaded into the local buffer.
5. If you attempt to change the frequencies at which you plan to use an antenna, whether it is a newly created antenna or an old one, you must delete the local buffer and start over as though it is a new antenna. To delete the local buffer, select item 4, DELETE from EDIT ANTENNA TABLE and then select item 6, EDITING BUFFER. Confirm the deletion by pressing [Y] and proceed as though you are creating a new antenna table.

**Table 4-4: The Applications (APPL) Menu**

Selection	Description
2 NOISE NORM'D BW	Enables keypad entry of noise measurements for normalized bandwidth
3 PERCENT OCCUPIED BW	Energy percentage for occupied BW measurements

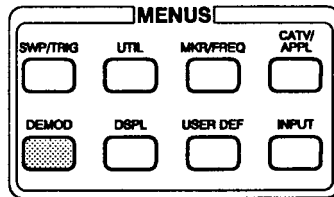

**Table 4-5: The Demodulator (DEMOD) Menu**

Selection	Description
0 OFF	Connects output of AM demodulator, FM demodulator, both, or neither (OFF) to internal speaker and headphone jack; LEVEL knob controls volume
1 AM DEMODULATOR	
2 FM DEMODULATOR	
3 BROADCAST (AM) VIDEO	Indicates selected video detect mode and turns it on and off
9 VIDEO MONITOR SETUP	
0 VIDEO DETECT MODE	Selects BROADCAST (AM) or SATELLITE (FM) video detection; does not work with scrambled signals
1 SYNC POLARITY	Toggles sync pulse and video signal polarity between positive and negative
2 VIDEO POLARITY	

Table 7-1: Equivalent Decibel — Voltage Values

<b>dB<math>\mu</math>V/m</b>	<b>0</b>	<b>4</b>	<b>8</b>	<b>12</b>	<b>16</b>	
0	1	1.58	2.51	3.98	6.31	microvolt per meter
20	10	15.8	25.1	39.8	63.1	
40	100	158	251	398	631	
60	1	1.58	2.51	3.98	6.31	millivolt per meter
80	10	15.8	25.1	39.8	63.1	
100	0.1	0.158	0.251	0.398	0.631	volt per meter
120	1	1.58	2.51	3.98	6.31	

8. Press **[INPUT] [6]** and enter any external gain or attenuation (skip this step if none is present). This number should include the gain or attenuation of any external amplifier or filter, and the losses of any balun that are not included in the manufacturers K factor table for your antenna.
9. Connect your antenna and proceed with your measurement. To obtain a measure of the maximum signal strength, save the measurement in the A or B register and select MAX HOLD. Rotate the antenna until the maximum reading is obtained.
10. Turn on the marker and use it to read out the field strength directly in dB $\mu$ V/m or V/m.

While using the dB $\mu$ V/m unit, you cannot unsave the destination register or use the LIN, FM DEMODULATOR, or EXTERNAL SOURCE features (you also cannot select the dB $\mu$ V/m unit while using these features). Attempting to do so will result in an error message.

If you turn off the destination register while using dB $\mu$ V/m, the message DBUV/M MEASUREMENT MODE IDLE is displayed.

The dB $\mu$ V/m measurement is not made while idling, and you still cannot unsave the destination register or use the LIN, FM DEMODULATOR, or EXTERNAL SOURCE features.

To disable the dB $\mu$ V/m measurement mode, select any other reference unit.

If you are using an antenna for the first time, you need to create an antenna table. From time to time you may also need to alter an existing table. Whether creating new antenna tables or changing old tables,

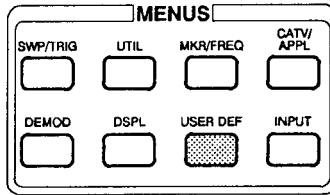

**Table 4-6: The User Definable (USER DEF) Menu**

Selection	Description
0 program 0 :	User-defined programs (UDPs) of keystroke sequences; recall and execute by pressing [USER DEF] [program #]
8 program 8	
<b>9 USER DEF PROG UTILITIES</b>	Firmware utilities used to create UDPs
0 ACQUIRE KEY STROKES <sup>6</sup>	Used to begin acquiring keystrokes or to exit acquire mode without storing UDP
1 TITLE EDIT	Used to create/modify name of UDP
2 WAIT FOR END OF SWEEP	Used as keystroke in UDP to delay UDP until sweep finishes; displays WAIT FOR END OF SWEEP; needed by functions utilizing end-of-sweep processing (count, cent meas, etc.)
3 DISPLAY MESSAGE	Used to create/delete messages for on-screen display during UDP execution
4 PAUSE FOR "USER DEF" KEY	Used as a keystroke in UDPs to generate PRESS USER DEF KEY TO CONTINUE message and halt program execution until [USER DEF] is pressed
5 CONTINUOUS EXECUTION	Causes subsequently chosen UDP to repeat continuously

**6** Changes to EXIT ACQUIRE MODE if already in acquire mode.

With the 2714, you enter the attenuation using the EXTERNAL ATTEN/AMPL feature from the INPUT menu and the antenna factor, measurement distance, and reference distance using the DBUV/M SETUP under the REFERENCE LEVEL UNITS of the INPUT menu. Note that many commercial antenna suppliers include the balun losses in the antenna factor. For the most accurate results, use an antenna calibrated at the specified reference distance and perform the measurement at that distance. If possible, measure the return loss of the antenna to make certain it is properly tuned to the desired frequency. See Tektronix application note 26W-7037-1, *Spectrum Analyzer Fundamentals*, concerning return loss measurements.

To use the  $\text{dB}\mu\text{V}/\text{m}$ , follow this procedure.

1. Select item 3, REF LEVEL UNIT, from the INPUT menu.
2. Select item 9, DBUV/M SETUP, from the REFERENCE LEVEL UNITS submenu.
3. Select item 6, MEASUREMENT DISTANCE, from the DBUV/M SETUP, and enter the distance at which the measurement will actually be carried out (default distance is 3.0 m). You can enter distances in feet, meters, kilometers, or miles, but the 2714 converts them to meters or kilometers before displaying them.
4. Repeatedly select item 7, SAVE RESULTS IN WFMx, until the indicated register (A, B, C) is the one in which you want the resulting measurement to appear. The waveforms are repeatedly saved, deleted, saved, and so on until you terminate the  $\text{dB}\mu\text{V}/\text{m}$  mode. At that point, the last sweep is retained in the selected register.
5. Item 9, MARKER DISPLAY, controls whether the on-screen marker amplitude reads out in decibels relative to a microvolt per meter (DBUV/M) or directly in volts per meter (V/m). The reference unit does not change; only the marker amplitude readout changes. Toggle item 9 to select the units you prefer. Table 7-1 also lists equivalent voltage and decibel values in 4 dB steps. Interpolate between values if closer results are required.
6. Select the antenna number (1 through 5) that matches the antenna you are using.
7. Press the back arrow key to return to REFERENCE LEVEL UNITS and select item 5, DBUV/M IN WFM x.

**Table 4-6: The User Definable (USER DEF) Menu (Cont.)**

Selection	Description
6 STORE	Stores the UDP currently being edited in location 0–8; location must be empty before UDP can be stored; if UDP is named, name appears next to number
7 DELETE	Deletes UDPs by number
8 PROTECT	Protects stored UDPs by number from deletion; # indicates protected UDP
9 TIME DELAY SETUP	Provides for delayed running of a UDP, and allows for a specified number of repetitions

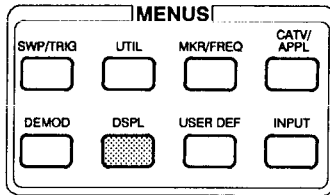

**Table 4-7: The Display (DSPL) Menu**

Selection	Description
<b>0 DIGITAL/ANALOG</b>	Toggles between the analog mode (all display registers off) or the digital mode — selecting digital will return to the display register configuration in effect prior to selecting analog
<b>1 ENSEMBLE AVERAGING</b>	
1 INITIATE AVERAGING	Starts averaging process
2 TERMINATE AVERAGING	Ends averaging process

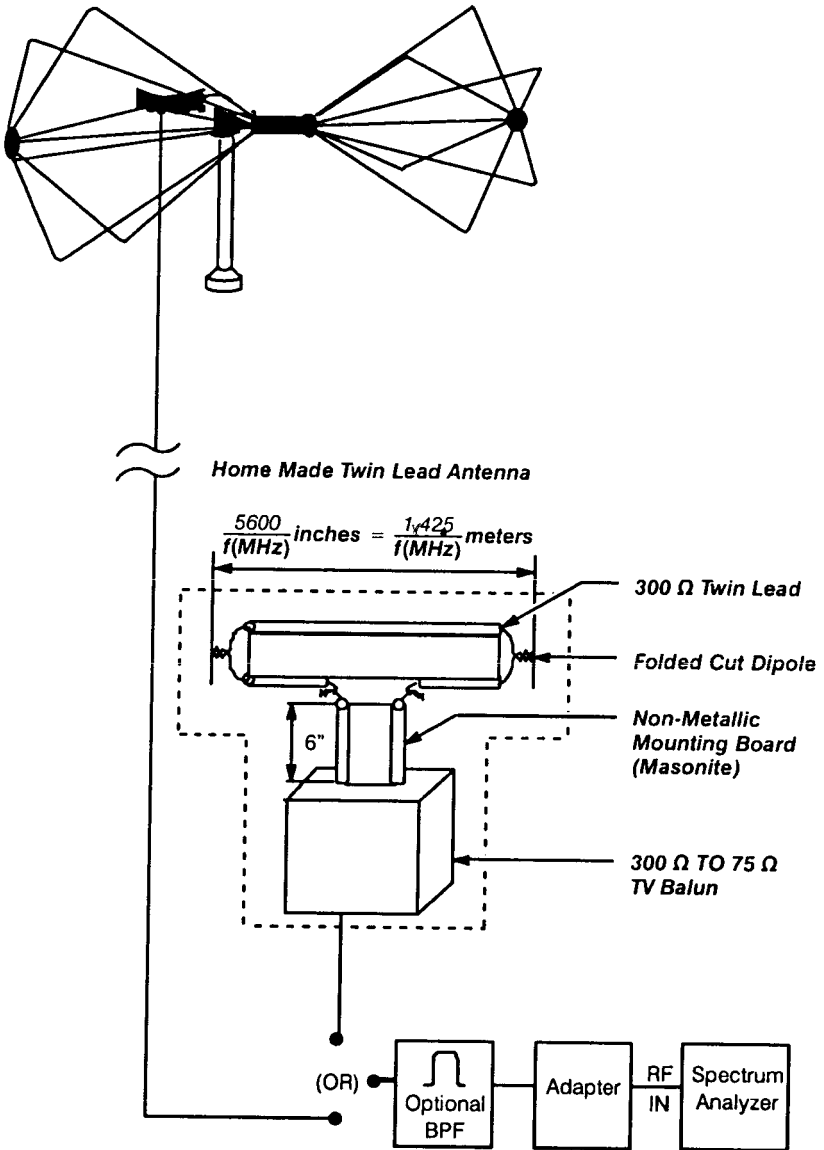

**Figure 7-4: Equipment Setup for Field Strength Measurements**



**Table 4-7: The Display (DSPL) Menu (Cont.)**

<b>Selection</b>	<b>Description</b>
3 MAX	Finds the average maximum, minimum, or max/min spectrum values — MEAN finds the average half way between the max & min points
4 MEAN	
5 MIN	
6 MAX/MIN	
7 NUMBER OF AVERAGES	Averages 1–1024 traces or selects continuous averaging
8 SAVE RESULTS IN DISPLAY	Toggles among display registers A, B and C; indicated register stores average
2 B,C MINUS A	Subtracts contents of A register from B or C registers if they are active
3 B,C MINUS A OFFSET TO	Offset result of subtraction to top or center of screen (0 difference equals reference level or midscreen)
4 ACQUISITION MODE	Toggles between peak & max/min spectral display
5 TITLE MODE	Enables entry of on-screen title and plot labeling information; turns display of title and plot labeling information on and off
6 GRATICULE ILLUMINATION	Turns graticule light on and off
7 DISPLAY SOURCE (AM)	Toggles between INT and EXT signal source, and indicates mode (AM, FM, QP) when INT is selected
8 DISPLAY LINE	Controls display line and limit detector
1 ON/OFF	Toggles display line (horizontal line at specified amplitude) on and off
2 VALUE ENTRY	Enables keypad entry of display line amplitude
3 DISPLAY LINE TO MARKER	Sets display line amplitude to current marker amplitude

## The Menu

The following formula relates the radiated field strength in dB relative to a microvolt per meter ( $\text{dB}\mu\text{V}/\text{m}$ ) to the measured signal amplitude in dB relative to a millivolt ( $\text{dBmV}$ ), and scales the result measured at a distance  $d_{\text{meas}}$  to a reference distance,  $d_{\text{ref}}$ . (The reference distance is often specified by the regulatory agencies.)

$$P_{\text{dB}\mu\text{V}/\text{m}} = P_{\text{dBmV}} + 13 + 20 \log \left[ \frac{d_{\text{meas}}}{d_{\text{ref}}} \right] - A + K$$

$d_{\text{meas}}$  = distance from radiation source at which the measurement is carried out

$d_{\text{ref}}$  = reference distance at which the intensity is desired

A = attenuation or gain between antenna and 2714. If the filter is used, its gain or attenuation should be included in this number. If balun losses are not included in the antenna factor, they should be included here. Cable loss, if significant, can also be included here.

K = antenna factor; supplied by manufacturer or calculated from the following:

$$K = 20 \log f - G - 10 \log (19 \times R_{\text{ant}})$$

G = antenna gain as a function of frequency

f = frequency of signal in MHz

$R_{\text{ant}}$  = output resistance of the antenna or the balun, if the balun is treated as part of the antenna

**Table 4-7: The Display (DSPL) Menu (Cont.)**

Selection	Description
4 LIMIT DETECTOR	Sounds audible alarm (limit detector) if signal is above line, signal is below line, or signal is below line but above threshold — set using [MKR/FREQ] [9] [1]
9 MIN HOLD IN WFM nn	Accumulates minimum value of spectrum and enables selection of register in which to store result

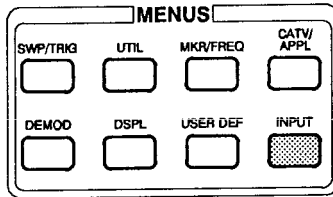

**Table 4-8: The Input (INPUT) Menu**

Selection	Description
1 PREAMP	Toggles built-in preamp on and off
3 REF LEVEL UNIT	Selects indicated reference unit
0 DBM	Selects milliwatt reference unit
1 DBMV <sup>7</sup>	Selects millivolt reference unit
2 DBV	Selects volt reference unit
3 DBUV	Selects microvolt reference unit
4 DBUW	Selects microwatt reference unit
5 DBUV/M IN WFMx	Selects microvolt per meter reference; user DSPL to select display register
9 DBUV/M SETUP	Enables entry of antenna factors and test distances

7 This is the only active selection when in the normal, CATV Mode.

Item 1 of the INPUT menu toggles the preamplifier on and off. The preamplifier is now turned on as indicated by the term PRE following the reference level readout.

Again note the noise floor. It should be approximately 12 dB lower than before. The 2714 has automatically reduced its internal gain (thus lowering the normal noise floor) to compensate for the added gain of the preamplifier. The result is that you can now see signals that are up to 12 dB below the normal 2714 noise floor. Toggle the preamplifier off.

## Using the DBUV/M

The decibel relative to a microvolt per meter ( $\text{dB}\mu\text{V}/\text{m}$ ) is an electric field strength unit that characterizes the intensity of radiated RF energy. Typically, the radiated signal amplitude is measured at the terminals of a calibrated antenna to determine the field strength.

With most spectrum analyzers, you then correct the measured signal amplitude for any external gain or attenuation, convert signal amplitude to radiated intensity using the antenna factor (often referred to as the K-factor) for your antenna, and scale the field strength for the difference between the measurement distance and the required reference distance. There is ample opportunity for calculation errors.

However, the 2714 performs the correction, conversion and scaling for you. Input the external gain or attenuation, antenna factor, and measurement distance using the INPUT menu. Then, select the  $\text{dB}\mu\text{V}/\text{m}$  reference unit and the 2714 does the rest. The signal intensity is read out on screen using the marker and corrected for distance, in either  $\text{dB}\mu\text{V}/\text{m}$  or  $\text{V}/\text{m}$ . Using the DISPLAY menu, it is also possible to have the 2714 sound a high-level, audible alert if the measured signal exceeds a threshold that you set. This feature facilitates go/no-go or present/absent tests.

Figure 7-4 shows how to set up your equipment. A balun may be included as part of your antenna. The filter and external matching network are optional. The filter is intended primarily to prevent off-the-air signals, such as radio and television, from swamping the 2714. The matching network may be necessary for maximum accuracy. If in doubt, try the measurement with and without the network. If there is no difference, omit the network for maximum sensitivity.

**Table 4-8: The Input (INPUT) Menu (Cont.)**

<b>Selection</b>	<b>Description</b>
<b>4 1ST MXR INPUT LVL</b>	Enables keypad entry of first mixer input amplitude that deflects display to the reference level
<b>5 RF ATTENUATION</b>	Enables keypad entry or AUTO selection of RF attenuation
<b>6 EXTERNAL ATTEN/AMP</b>	Signifies whether external attenuation or amplification is present, and enables keypad entry of amount
0 ON/OFF	
1 ATTEN/AMP ENTRY	
<b>9 CAL SIGNAL @100MHZ 18.8DBMV</b>	Toggles built-in calibrator on and off

A -20 dBm level at the first mixer input allows you to get an additional 10 dB of sensitivity by reducing the RF attenuation 10 dB and decreasing the IF gain 10 dB to compensate. The danger is that internally generated distortion products may become more noticeable.

To change the signal level at the mixer, press **[INPUT] [4]**.

You are prompted to enter a new mixer input level. You can enter values from -50 dBm to -20 dBm in 2 dB steps. Try -20 dBm and -40 dBm while observing the level of the noise. Because the RF attenuation is increased by the same amount the first mixer input is decreased, and the noise floor rises as the mixer level is reduced. When you are done experimenting, set the mixer input level back to -30 dBm.

### Turning the Preamplifier ON/OFF

100.0MHz	(AUTO SWEEP)	ATTN 0DB
0.0DBMV		VF 300KHz
5MHz/		10 DB/
300KHz RBW (AUTO)		

The 2714 is equipped with an internal preamplifier. The preamplifier can be very useful when measuring cable TV noise (see the C/N discussion later in this section) or other signals near or below the normal 2714 noise floor. It is also useful for increasing the sensitivity of radiated RF energy measurements (leakage, etc.). The nominal gain in sensitivity using the preamplifier is 12 dB. Above 600 MHz the preamplifier remains usable and useful, but its flatness rolls off somewhat and is not specified. To be effective, the preamplifier must be used with no RF attenuation. The preamplifier is not normally turned on, because it can easily result in overdriving the first mixer. The signal amplitude at the first mixer with the preamplifier on and no RF attenuation is equal to the input signal level plus approximately 18 dB (that is, a 10 dBmV signal would probably overdrive the first mixer). Total signal amplitude greater than 0 dBmV at the input to the 2714 with the preamplifier turned on may create spurious signal components and produce unreliable amplitude measurements.

Note the level of the noise floor and then press **[INPUT] [1]**.



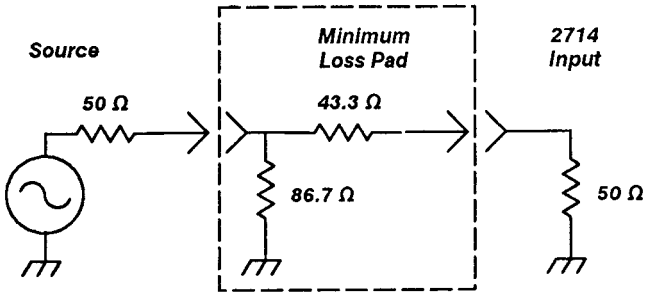

**Figure 7-3: 75/50  $\Omega$  Matching Minimum Loss Pad**

If in doubt whether the pad is needed, compare a measurement with the pad to the same measurement without the pad. If there is no significant difference, omit the pad. In some cases, such as carrier-to-noise measurements, the use of a pad may drop your system noise level below the 2714 noise floor. In such cases, the pad cannot be used. Removing the pad typically does not distort C/N measurements.

When a  $50\ \Omega$  source is frequently used, you can store the settings above in one of the STORED SETTINGS registers (see the UTIL menu discussion later in this section); then you merely have to recall the settings each time a  $50\ \Omega$  source is used with the 2714.

## Setting the First Mixer Input Level

Overdriving the 2714's first mixer circuit can generate spurious signals and cause inaccurate measurements. As the signal amplitude increases past the maximum linear range of the circuit, its output amplitude becomes less than it should be. This creates lower-than-actual amplitude measurements. On the other hand, if the signal amplitude at the mixer is too low, signals may become lost in the 2714's internal noise. An optimum compromise is achieved within the 2714 by making the top graticule line represent a  $-30\ \text{dBm}$  level at the input to the first mixer.

However, in cases where total signal energy is large, it may be beneficial to restrict the input to the mixer to a smaller value. By resetting the first mixer input level to, say,  $-40\ \text{dBm}$ , you increase the RF attenuation by 10 dB while simultaneously increasing the IF gain 10 dB. This provides additional protection to the first mixer. In other cases, you may want to examine a low-level signal adjacent to a high-level signal.





# Dedicated Controls

## Accommodating a 50 Ω Source

The 2714 has a 75 Ω input impedance and expects a 75 Ω signal source impedance. However, a 50 Ω source impedance is typically associated with some applications that use dBm as a standard amplitude measurement unit. The 2714 provides two ways to make 50 Ω measurements.

- When making narrowband measurements (for example, carrier-to-noise ratios, relative amplitudes of signals close together in frequency, interference levels relative to a nearby signal), you can generally connect the 2714 directly to a 50 Ω source. If a 50 Ω source is connected to the input of a 50 Ω instrument, the voltage will be 1.6 dB lower than it is with the same source connected to the 75 Ω input of the 2714. We can also calculate that 0 dBmV dissipated in 75 Ω is equal to -48.8 dBm across 50 Ω. The total difference is, therefore, -50.4 dB.

For these cases, use item 6 of the INPUT menu (EXTERNAL ATTEN/AMPL) to enter a 1.6 dB offset to the reference level. See Accommodating External Amplification/Attenuation earlier in this section.

- When making broadband measurements or measurements of absolute amplitude (for example, antenna, system, or amplifier sweeps; absolute carrier amplitude; comparison of signals widely separated in frequency), you may want to present a matched load to the source to provide maximum flatness and to minimize standing wave ratios. You can do so by inserting the matching minimum loss pad shown in Figure 7-3 between the source and the 2714. To obtain correct dBm readings, set the INPUT menu measurement parameters as follows:

Item 3: REF LEVEL UNIT	DBM
Item 6: EXTERNAL ATTEN/AMPL	-4

In this case, you select the dBm unit via [INPUT] [3] [0] and the 50 Ω source because the 2714 is matched to the 75 Ω side of the minimum loss pad and the signal really is being terminated in a 50 Ω impedance. Further, it is the attenuation of the pad that is entered under item 6 and not its insertion loss. The 7.5 dB accounts for both the insertion loss and the fact that the signal at the input to the minimum loss pad is 1.9 dB less than it would be if the 50 Ω source were connected directly to the 2714.



Each of the six units except the DBUV/M (dB relative to a  $\mu\text{V/m}$ ) represents a simple change of scale. Be aware that the 2714 always measures the voltage at its input across its  $75\ \Omega$  input impedance, and then scales the result according to the selected units. Because the DBUV/M is not just a simple unit conversion, it is discussed separately in a later section.

Enable the CATV mode again by pressing **[CATV/APPL]**, and continue.

## Accommodating External Amplification/Attenuation

When you wish to measure a high amplitude signal, it is possible that you will have to attenuate the signal before inputting it to the 2714. (Remember, the maximum total signal power at the input to the 2714 should not exceed +70 dBmV, or 100 mW.) On the other hand, if you have a very weak signal, you may need to amplify it.

Ensure the calibrator is turned off, and select the INPUT menu. Item 6 indicates that there is presently no external attenuation or amplification. Select item 6. A secondary menu appears that enables you to enter the amount of external attenuation or amplification. Select item 1. Suppose you have attenuated an RF transmitter output 40 dB prior to measuring it. Following the on-screen prompts, press **[4] [0] [Z]**.

This procedure enters an external attenuation value of 40 dB. The spectral display does not change, but the reference level now indicates 58 dBmV and is followed by the term OFST.

This indicates that the reference level has been offset, in this case by 40 dB. Any reference level now entered is offset automatically by the external attenuation or gain.

To turn off the offset, first press **[INPUT] [6]**.

Item 0 indicates that the offset is turned on. Turn it off by selecting item 0. The spectral display will reappear, but OFST is gone.

Toggle the offset back on without re-entering the external attenuation value by pressing **[INPUT] [6] [0]**.

Now turn off the offset, and then enter a value of 0 dB for external attenuation



# Dedicated Controls

This section describes in detail the dedicated controls of the 2714. All of the dedicated controls are on the 2714 front panel except the trace alignment controls, which are on the back. These dedicated controls are used to carry out the most common and general, spectrum analyzer operations without the need to call up the menus. The first part of the section covers the controls that initiate frequently performed actions. Included in this category are all the operating increment and decrement functions of span, channel entry, frequency, and reference level. The second part of the section covers the enhanced versatility controls that increase your ability to make accurate spectral measurements easily and conveniently.

Item 5 indicates that the RF attenuation is 30 dB and that it is selected automatically by the 2714. We can control the RF attenuation so that it remains at a fixed value.

Select item 5 and this prompt appears:

```
ENTER NEW VALUE OR "W": _  
( 0 TO 50 IN 2 DB STEPS )  
W = AUTO
```

Enter a fixed value of 30 dB by pressing **[3] [0] [Y]**.

The display returns unchanged. Again press **[↵]** twice. Now the signal peak and the noise floor both rise. This is because pressing **[↵]** twice increased the 2714 IF gain by 20 dB to lower the reference level, but the RF attenuation is unchanged.

Press **[INPUT] [5] [W]** to place the RF attenuation back in the automatic mode.

### Changing Reference Level Units

Change the reference level units by selecting the APPL menu. Select item 8, CATV MEASUREMENTS SETUP, then item 6, REF LEVEL UNIT. Item 6 toggles between DBUV and DBMV, as indicated on the right side of the screen.

There is an alternate method to change reference level units from the INPUT menu. Select item 3, REF LEVEL UNIT, and six selections are shown. Item 1, DBMV, and item 3, DBUV, are the only available selections; all others are selectable only in the non-CATV mode. If items 0, 2, 4, or 5 are selected, error message FUNC NOT AVAILABLE IN CURRENT MODE will appear; these items are available only after exiting from the CATV mode, which is described below.

Disable the CATV mode by pressing **[CATV/APPL] [8] [0]**. Ensure the reference level is set to 18.8 dBmV and then choose item 3 from the INPUT menu.

A list of six possible units appears. Select item 2, dBV. The spectral display is restored, but the reference level now reads -41.2 dBV because 1 mV is 60 dB below a 1 V reference. Only the units change, not the 2714 gain, attenuation, or input impedance. Therefore, the displayed spectrum is unchanged.

Change the units back to dBm and turn off the calibrator.



The Input menu controls 2714 parameters that alter signal sensitivity, change measurement amplitude units, and turn the calibration signal on and off.

To call up the Input menu, press **[INPUT]**.

The menu shown in Figure 7-1 appears on screen.

## Turning the Calibrator On and Off

The word OFF following item 9 of the INPUT menu indicates the calibrator signal is turned off. Turn on the calibrator signal by pressing **[9]**.

The spectral display reappears and the word CALIBRATOR is now displayed at the lower right of the screen indicating the calibrator signal is on. The calibrator signal is the peak at center screen. Turning on the calibrator also internally disconnects the RF input path from the RF Attenuator and prevents viewing external signals.

Press **[INPUT]** again.

The word following item 9 now is ON. In this way, the menu enables you to toggle between the two possible settings and displays the current setting.

Turn the calibrator off by pressing **[9]** again.

You get the spectral display back but without the word CALIBRATOR displayed. Press **[INPUT]** **[9]** once again to turn the calibrator back on.

## Setting the RF Attenuation

Set the reference level to 48.8 dBmV with **[REF LEVEL]** **[4]** **[8]** **[.]** **[8]** **[Y]**. Press **[↔]** to the right of **[REF LEVEL]** twice. Notice that the signal peak rises but the noise floor does not.

This is because the RF attenuation decreased each time you pressed the key. The increased signal height is achieved by reducing attenuation. However, the noise floor is generated after the RF attenuator, so it is not affected.

Reset the reference level to 48.8 dBmV and select the INPUT menu.





# Fundamental Operations

Section 3 described the amplitude and frequency measurement of a continuous narrow-band signal (the calibration signal) using only three controls. This section will repeat the initial measurement, but this time with the [CHAN/FREQ], [SPAN/DIV], [REF LEVEL], and associated controls contained in the gray-colored central function block. These controls are fundamental to most spectrum analyzer operations. You can perform a majority of spectral measurements with only these controls.

First set the 2714 controls to the values shown in the following settings box.

<b>Frequency</b>	<b>(AUTO SWEEP)</b>	<b>ATT 50DB</b>
<b>38.8DBMV</b>		<b>VF 300KHZ</b>
<b>600.0KHz/ MAX</b>		<b>10 DB/</b>
<b>300KHz RBW</b>	<b>Channel Table Name</b>	<b>CH nn</b>
		<b>CALIBRATOR</b>

*Frequency = Center of default power-up channel, center of currently selected channel, or selected frequency*

*nn = Channel number*

This is most easily done by pressing [UTIL] [1] [1] to recall the factory default settings.

---

## SPAN/DIV

The span controls change the total display frequency span range symmetrically about the center frequency, select channel table entries, and set the 2714 in the maximum span or zero span modes.

1. Press [INPUT] [9] to turn on the calibration signal.
2. Press [MKR/ $\Delta$ /OFF] twice to turn off the markers.

There are three ways to exit from a menu.

- Many selections cause the 2714 to revert automatically to the measurement mode it was in before calling up the menu. In some cases a small delay is provided between making the selection and reverting to the spectral display to enable you to see the status indicator at the end of the menu line change. However, the change is also reflected in the on-screen readouts in many cases, or by the nature of the spectral display itself.

The following prompt is displayed at the bottom of all menus prior to making a selection.

**PRESS ANY MENU KEY TO EXIT  
PRESS BKSP FOR PREVIOUS DISPLAY**

- Simply pressing a menu key returns instantly to the spectral display. You can use this technique also if you decide not to make a selection.
- Pressing the backspace key, **[BKSP]**, returns to the previous menu. If there is no previous menu, you return to the spectral display. The backspace key can, therefore, be used to return to a previous menu to alter a selection, or to back entirely out of a menu and return to the spectral display.

In general, menus are not reproduced here. It is intended that you call up menus on the 2714 and follow along with the examples in this section as they are described. For a handy reference, consult Section 4, *Operation Summary*.

To view the attenuation and video filter screen readouts, turn the markers off during these menu descriptions (menus are turned on by default).

---

## Input

100.0MHz	(AUTO SWEEP)	ATTN 12DB
28.8DBMV		VF WIDE
600KHz/		10 DB/
300KHz RBW (AUTO)		

## Fundamental Operations

3. Press [CHAN/FREQ] [4] [0] [0] [X] to set the 2714 center frequency to 400 MHz.
4. Press [MAX] and [AUTO] RES BW. Remember that in MAX SPAN the marker changes position and not the frequency at screen center.
5. Press [REF LEVEL] [3] [8] [•] [8] [Y] to set the reference level to 38.8 dBmV.

### Arrow Keys

The arrow keys to the right of [SPAN/DIV] change the frequency span represented by one horizontal division on the screen. The arrows directly increase or decrease the span per division.

Beginning with maximum span, press [↔] to the right of [SPAN/DIV] several times to decrease the span/div to 20 MHz.<sup>1</sup> This causes the 2714 to zoom in on the spectral display. Now press [←] until the span/div increases to 180 MHz. Watch the spectral display zoom out just as though it was moving away from you.

The up arrow increases the span/div, compressing or squeezing the spectrum together. The down arrow decreases the span/div and expands or stretches the spectrum. The arrow keys are active whenever the 2714 is in the spectral display mode.

Experiment by pressing each arrow key until the span/div no longer changes. You will notice two characteristics of the 2714.

- Span/div changes in a 1–2–5 sequence between 1 kHz and 100 MHz, plus 180 MHz/div in maximum span
- Resolution BW changes automatically as the span changes (later we show how this can be changed)

### Keypad Entry

The preset span/div values are sufficient for most measurement needs. However, other span/div settings can be specified to the nearest tenth of a unit.

<sup>1</sup> If you request a narrow span before the 2714 is completely warmed up, you may get a NORMALIZATION SUGGESTED message. This message should not appear after the 2714 warms up.

TRIGGER MENU	
0*FREE RUN	
1 INTERNAL	
2 EXTERNAL	
3 LINE	
4 TV LINE	
5 TV FIELD	
SWEEP MENU	
*6 SWEEP RATE	50MS/DIV
7 MANUAL SCAN	OFF
8 SYNC POLARITY	POSITIVE
9 SETUP TABLE	
ENTER NEW VALUE: INPUT MENU	
(1-2-5 SEQUENCE)	

**Figure 7-2: Sweep/Trigger Menu with SWEEP RATE Selection Chosen**

To enter a setting or parameter value, press the sequence of number keys representing the numerical value, and then press the appropriate terminator key. The numbers appear on screen as you type them, but they are not entered until you press the terminator key.

If you make a mistake, you can correct it any time prior to pressing a terminator by repeatedly pressing **[BKSP]** (the backspace key) until the incorrect number disappears and then typing the correct value.

The terminator keys (**[W]**, **[X]**, **[Y]**, and **[Z]**) determine the units and enter the data. Each key can represent several units, but they are context-sensitive, and the 2714 will determine the intended unit based on the parameter or setting you are attempting to modify. For instance, **[X]** can represent MHz, mSEC, or mV, and if you are attempting to enter a sweep rate, the 2714 will correctly interpret the units as msec when you press **[X]**.

To enter a value of 20 milliseconds, press **[2] [0] [X]**.

Whereas, to enter 20 microseconds, press **[2] [0] [Y]**.

Entering a value for the sweep rate also removes the sweep rate parameter from automatic selection. To return to automatic selection, you press **[AUTO]** in the SWEEP function block on the front panel.

To set the span/div to an arbitrary value, press **[SPAN/DIV]** to place span in the immediate entry mode.

Notice that the word SPAN appears at left center of the 2714 screen. The word SPAN indicates that you can enter the span/div directly from the keypad (immediate entry mode) by keying in a permissible value followed by an appropriate terminator key. Any value from 1 kHz/div to 180 MHz/div is acceptable. You can enter up to 25 characters, but the 2714 rounds the value to three decimal points and stores it. In the spectral display, the value is shown rounded to one decimal point (to see the stored value, press **[UTIL] [2]**).

For example, to set the span/division to 33.3 MHz, press **[3] [3] [.] [3] [X]**.

The numbers you type appear on screen to the right of SPAN. If you make a mistake, you can correct it any time prior to pressing **[X]** by repeatedly pressing **[BKSP]** (the backspace key) until the incorrect entry disappears and then entering the correct value.

Pressing a terminator button (**[W]**, **[X]**, **[Y]**, or **[Z]**) determines the units and enters the data. **[X]** can represent units of MHz, mSEC, or mV. Because the immediate span/div entry mode requires a frequency, the 2714 correctly interprets the currently displayed value as 33.3 MHz when you press **[X]**. If a time or voltage unit had been required, the 2714 would have interpreted your entry as 33.3 mSEC or 33.3 mV, respectively, when you pressed **[X]**. On the other hand, had you wanted the entry to represent a span/div of 33.3 kHz, you would have pressed **[Y]** instead of **[X]**.

Press **[▼]**, and the span/div changes to 20 MHz; the nearest span/div value in the downward direction in the normal 1–2–5 sequence. Had you pressed **[▲]**, the span/div would have changed to 50 MHz; the nearest value in the upward direction.

The span readout now indicates 20MHZ/ and the 4<sup>th</sup> harmonic of the calibration signal is at the center frequency of 400 MHz.

## MAX

There is often a need to view the entire input frequency range of the 2714, such as when connecting new signals to the 2714 input. In this mode, the 2714 is in MAX SPAN. The dedicated front-panel key is provided to conveniently enter and exit this mode.

## The Menus

A feature status indicator on the right side of the menu item shows the present value or condition of that parameter or feature. See Figure 7-1 as an example. The status indicator is updated as you make selections or alter parameters.

Depending on the parameter or feature, there are three ways the status may be changed; each uses the numeric keypad.

- When only two or three values or conditions are permitted, pressing the keypad key corresponding to the item number cycles through the acceptable values. At each step, the new status appears at the end of the line.
- If the 2714 accepts a smaller range of values, it presents a secondary menu consisting of a list of the values that may be selected by pressing their corresponding keypad key.
- If a parameter can have a wide range of numerical values, two things happen. First, The selected item number is preceded by an asterisk (to ensure there is no confusion about which item was selected). Then you are prompted to enter the new value. This is illustrated in Figure 7-2 where item 6 from the SWP/TRIG menu has been selected.

INPUT MENU	
1 PREAMP	OFF
3 REF LEVEL UNIT	DBM
4 1ST MXR INPUT LEVEL	-30DBM
5 RF ATTENUATION	AUTO 50DB
6 EXTERNAL ATTEN/AMPL	NONE
9 CAL SIGNAL@100MHz 18.8DBMV	OFF
PRESS ANY MENU KEY TO EXIT	
PRESS BKSP FOR PREVIOUS DISPLAY	

**Figure 7-1: The INPUT Menu**

## Fundamental Operations

Press **[MAX]** to obtain the largest span available on the 2714. The span/div readout now indicates 180MHz/MAX. Press **[MAX]** a second time to return to 20KHZ/.

Many of the keys on the 2714 are toggle-action. The ability to undo an action by pushing the same button that carried out the action is typical. **MAX** is a toggle-action key taking you from the current span/div to 180 MHz/div and back.

### ZERO

For the next example, set the center frequency to 100 MHz and notice that the calibration signal is centered in the display.

Press **[ZERO]**, and the signal is a straight, horizontal line. In the zero span mode, the 2714 remains at a fixed frequency. What you see is the variation in time of the signal power coming through the RBW filter at that frequency. Since the calibration signal has constant amplitude, the display is constant. Slowly increase the center frequency by turning the **FREQ/MKRS** knob. The noise generated internally by the 2714 has a time-varying random amplitude. The signal amplitude decreases and the noise increases as you tune away from the calibration signal.

In the zero span mode, the 2714 does not sweep the frequency spectrum. Rather, the local oscillator remains at a fixed frequency so that the resolution bandwidth filter brackets the designated center frequency. Because the display screen is still swept, the span readout indicates sweep speed (time per division rather than frequency per division). The word ZSPAN follows the sweep speed to denote zero span operation. In a sense, you have turned your spectrum analyzer into an oscilloscope.

**ZERO** is another toggle-action key. Press the key again to return to 20 MHz/div span.

---

## Channel Entry

### Arrow Keys

Press **[UTIL] [1] [1]** to restore the factory defaults.

Press **[▲]** adjacent to **[CHAN/FREQ]**. The channel selection steps to the next channel in the selected channel table.



# The Menu

This section describes the menu-selected, firmware-driven features of the 2714. The menus provide a high degree of sophistication without a complicated control panel.

Press any key in the front-panel MENU function block to cause a menu to be displayed on the screen. The menus enable you to perform a variety of tasks (as listed below), some of which are not convenient using the front-panel dedicated controls.

- Displaying and centering TV channel signals
- Automating measurements
- Controlling 2714 operational modes
- Changing control increments and settings
- Storing and recalling control settings
- Normalizing the 2714
- Executing diagnostic routines

Each menu is a list of numbered items. Choosing an item often results in a sub-menu being displayed. Some infrequently used items from the sub-menu may call up a secondary sub-menu. A few items from the menus are neither listed nor explained in the following discussions: these represent factory troubleshooting and calibration aids not intended for general operator use. Some items discussed may not appear in your instrument because of the installed options.

An overview of the menus is included in Section 4, *Operation Summary*. The overview should provide all the information you need to use the menus, once you become familiar with the menu features.

---

## Using the Menu

From the spectral display mode, first press the appropriate menu key in the MENUS function block, then press the number key on the keypad corresponding to the desired selection. If you are in a menu, a menu key just takes you back to the spectral display mode.



The arrow keys are used to step through the channels in the selected channel table.

Now press [ ← ] adjacent to [CHAN/FREQ]. The channel selection steps to the previous channel.

The up arrow selects the next higher channel in the channel table, whereas the down arrow selects the previous channel. The keys remain active whenever the 2714 is in the spectral display mode.

### Keypad Entry

CHAN/FREQ defaults to CHAN whenever the CATV mode is active. The abbreviation CHAN appears at left center of the 2714 screen. CHAN indicates that you can enter the channel number directly from the keypad. This is done by keying in a permissible channel number (according to the selected channel table) followed by [W]. Enter the desired channel number with the front-panel keypad to select a channel.

#### NOTE

*In the CATV mode, frequency can be entered by terminating the entry with the [X], [Y], or [Z].*

*In the non-CATV mode, [CHAN/FREQ], the associated [ ↕ ] and [ ← ], and all the terminator keys exclusively control frequency. The non-CATV mode is enabled by pressing [CATV/APPL] [8] [0].*

For instance, to select channel 8 in the specified table, press [8] [W]. The numbers appear on the screen to the right of CHAN. If you make a mistake, correct it any time prior to pressing [W] by repeatedly pressing [BKSP] (the backspace key) until the incorrect number disappears and then type the correct number.

Press [W] to end the entry, and the 2714 interprets the currently displayed value as Channel 8.

The other terminators are used for channel frequency entry. For example, if you enter a certain frequency, the displayed channel number defaults to the channel within whose limits the entry falls.



## Frequency Entry (Normal Mode)

The frequency controls set the 2714 normal center or start frequency.

### FREQ/MKRS

Press [INPUT] [9] to turn on the calibration signal. Press [1] [0] [0] [X] (to set the center frequency to 100 MHz), [SPAN/DIV] [1] [0] [0] [X] (to set the span to 100 MHz/division), [REF LEVEL] [3] [8] [•] [8] [Y] (to set the reference level to 38.8 dBmV), and RES BW [AUTO].

Turn the FREQ/MKRS knob a few clicks clockwise. Each click of the knob increases the center frequency by 2.0 MHz. Turn the knob counter-clockwise, and the center frequency decreases by the same amount. Now reduce the span to 20 MHz/div. Again turn the FREQ/MKRS knob a few clicks clockwise. The spectral display appears to move sideways at about the same rate as it originally did. However, it is now moving only 0.4 MHz per click. We call this visual behavior constant rate tuning. It occurs because the knob normally changes the center frequency at 0.02 of the span/div per click<sup>2</sup>. Obviously, it would take 250 clicks to change the frequency by 100 MHz at 20 MHz/div.

The knob remains active whenever the 2714 is in the spectral display mode.

### Arrow Keys

Press [↔] adjacent to [CHAN/FREQ]. The frequency changes by channel allocation width of the currently selected channel table (6 MHz for the STD, HRC, and IRC channel tables). If you had previously selected a channel by entering a frequency value that is not centered about the channel allocation width, the first increment will move the center frequency to the center of the next channel. Subsequent increments then default to the channel allocation width.

The up arrow selects the next channel, and the down arrow selects the previous channel. This means that even though the 2714 is in the CATV mode, you can increase and lower the center frequency by the channel allocation width using the up and down arrows. You can then fine-tune the center frequency using the FREQ/MKRS knob.

- 2 In MAX SPAN the indicated frequency changes alternately by 3 or 4 MHz and as a percent of the Resolution BW in ZERO SPAN. See Selecting the Tuning Increment in Section 7 for a description of how you can change the tuning rate.



# The Menu

The keys remain active whenever the 2714 is in the spectral display mode.

### Keypad Entry

For very large frequency changes, or to preset a known center or start frequency, the direct entry mode is faster. To set the center or start frequency to a predetermined value, press **[CHAN/FREQ]** to place the center or start frequency in the immediate entry mode.

Even though the word CHAN appears at left center of the 2714 screen, you can enter the center frequency directly from the keypad (immediate entry mode) by keying in a permissible value followed by an appropriate terminator key (**[X]**, **[Y]**, or **[Z]**). You can enter any value from 0 Hz to 1800 MHz, even though the 2714 low-frequency specification is 9 kHz. Your entry can contain up to 25 characters, but regardless of how many you enter, the 2714 attempts to control frequency to the nearest Hertz. The frequency is displayed at the top of the left-hand data column to 1% of the span/div.

For example, to set the center frequency to 1.25 MHz press **[1] [.] [2] [5] [X]**. The numbers you type appear on screen to the right of CHAN. If you make a mistake, correct it any time prior to pressing the MHz terminator by repeatedly pressing **[BKSP]** until the incorrect number disappears, and then type the correct value.

Pressing a terminator key (**[X]**, **[Y]**, **[Z]**) determines the units and enters the data. **[X]** can represent units of MHz, mSEC, or mV. Because the frequency immediate entry mode requires a frequency, the 2714 interprets the currently displayed value as 1.25 MHz when you press **[X]**. If a time or voltage unit had been required, the 2714 would have interpreted your entry as 1.25 mSEC or 1.25 mV, respectively, when you pressed **[X]**<sup>3</sup>. On the other hand, had you wanted the entry to represent a frequency of 1.25 GHz, you would have pressed **[1] [2] [5] [0] [X]**. (Use the correct multiple and **[X]** to select GHz while the 2714 is in the CATV mode.

Now use the direct entry method to set the center frequency to 100 MHz (**[CHAN/FREQ] [1] [0] [0] [X]**).

**3** However, neither is a permissible value at this menu level, and your entry would have been rounded to the nearest allowable value.



## Frequency Entry (Non-CATV Mode)

### Arrow Keys

Disable the CATV mode with **[CATV/APPL] [8] [0]** and press **[1] [0]**. Press **[▲]** adjacent to **[CHAN/FREQ]**, and the frequency changes by 10 MHz. (It would take ten presses of the arrow key to change the frequency by 100 MHz.)

The frequency arrow keys change the frequency by one division.

### Keypad Entry

Change the span/div to 100 MHz. Now press **[↔]** adjacent to **[CHAN/FREQ]**; and the frequency changes by one division (100 MHz). At large span/div settings, the arrow keys can change the frequency very rapidly.

For very large frequency changes, or to preset a known center or start frequency, the direct entry mode is faster. To set the center or start frequency to a predetermined value, press **[CHAN/FREQ]** to place the center or start frequency in immediate entry mode. The abbreviation **FREQ** appears at left center of the 2714 screen.

The abbreviation **FREQ** indicates that you can enter the center frequency directly from the keypad. This is done by keying in a permissible value followed by an appropriate terminator key. You can enter any value from 0 Hz to 1.8 GHz, even though the 2714 low-frequency specification is 9 kHz. Your entry can contain up to 25 characters, but regardless of how many you enter, the 2714 attempts to control frequency to the nearest Hertz, and the frequency is displayed at the top of the left-hand data column to 1% of the span/div.

For instance, to set the center frequency to 1.25 MHz press **[1] [.] [2] [5] [X]**. The numbers you type appear on screen to the right of **FREQ**. If you make a mistake, correct it any time prior to pressing **MHZ** by repeatedly pressing **[BKSP]** until the incorrect number disappears, and then type the correct value.

Pressing a terminator key (**[W]**, **[X]**, **[Y]**, **[Z]**) determines the units and enters the data. **[X]** can represent units of MHz, mSEC, or mV. Because the frequency immediate entry mode requires a frequency, the 2714 interprets the currently displayed value as 1.25 MHz when you press **[X]**. If a time or voltage unit had been required, the 2714 would have interpreted your entry as 1.25 mSEC or 1.25 mV, respectively,

## View Picture

View Picture provides demodulation of the video carrier on the current channel.

The instrument sets up for the video demodulation mode on the current channel with the following settings.

Frequency	1.5 MHz above Visual Carrier
Reference Level	Set to place the visual carrier peak at the reference level
Span/Div	Zero Span
Sweep Time	5 $\mu$ s/Div
Resolution Bandwidth	5 MHz

Both NTSC and PAL video channels are supported. The instrument stays in this mode until the mode is deselected, the channel is changed, or another test is run.

Item 3 in the **DEMOD** menu (BROADCAST <AM> VIDEO) is displayed as ON any time VIEW PICTURE is enabled.

To view the video picture, press **[CATV/APPL] [3]**. Video monitor mode is automatically enabled. Turn the outer **LEVEL** knob to obtain a full-size and locked picture. Also, you can change the reference level to obtain the best contrast.

To disable the VIEW PICTURE mode, press **[CATV/APPL] [3]** again or **[DEMOD] [3]**.

## Listen

To listen to channel audio, press **[CATV/APPL] [4]**. Use the outer **LEVEL** knob to set the audio level.

The display shows the instantaneous FM deviation.

Top-Screen	=	0 kHz
Deflection Factor	=	10 kHz/division

The other bright trace (waveform C) accumulates the peak deviation in MIN HOLD mode.

You can disable the LISTEN mode by pressing **[CATV/APPL] [4]** again or **[DEMOD] [0]**. However, if you use the **[DEMOD] [0]** selection to disable LISTEN mode, the active channel will not be recentered on the screen — you merely turn off FM demodulation.



when you pressed [X]. On the other hand, had you wanted the entry to represent a frequency of 1.25 GHz, you would have pressed [W] instead of [X].

Return the 2714 to CATV mode by pressing [CATV/APPL] [8].

Re-enable the calibrator by pressing [INPUT] [9] and set the reference level to 38.8 dBmV by pressing [REF LEVEL] [3] [8] [•] [8] [Y]. Press [MKR/Δ/OFF] twice to turn off markers.

Now use the direct entry method to set the center frequency to 100 MHz ([CHAN/FREQ] [1] [0] [0] [X]).

---

## REF LEVEL

The Ref Level controls adjust the reference level of the display and increment and decrement the reference level step size.

Following is a review of the reference level adjustment.

### Arrow Keys

Notice the height of the signal peak and then press [ ← ] adjacent to [REF LEVEL].

The signal peak appears to increase 10 dB when you press the key. *Actually, the calibration signal amplitude does not change amplitude when you change the reference level.* Instead, the reference level decreases (changes in the direction indicated by the arrow key) to 28.8 dBmV and the attenuation to 10 dB. The signal only appears larger because the reference level has been lowered 10 dB and now represents a signal level of 28.8 dBmV, 10 dB or one division greater than the calibration signal.

Reduce the on-screen signal height one division by pressing [ ↘ ] adjacent to [REF LEVEL].

The reference level readout increases 10 dB to 38.8 dBmV (again changes in the direction indicated by the arrow) and RF attenuation changes to 20 dB. The signal peak drops one division, but its amplitude is still 18.8 dBmV.

The up arrow increases the reference level, and the down arrow lowers it. The keys remain active whenever the 2714 is in the spectral display mode.

## CATV Measurements

When the operation is invoked, the 2714 tunes to the visual carrier and enables the 1 MHz resolution bandwidth filter and zero span.

The 2714 then finds and centers the peak of the visual carrier and places it at the reference level. The display storage and readouts are turned off, and short holdoff is selected for an analog display.

The 2714 sets the sweep time to 2 ms/div and the trigger mode to TV Field trigger.

To view field modulation, press **[1]**. The center frequency is set to the visual carrier frequency of the selected channel, zero span is enabled, the sweep rate is set to 2 ms/division, the resolution bandwidth is set to 1 MHz, and the readouts are turned off.

You should see at least one field of the video signal.

### Line Modulation

This operation allows you to view one line of demodulated video for the current channel in the analog mode.

The setup is the same as for field modulation except that the 2714 sets the sweep time to 10  $\mu$ s/div and the trigger mode to TV Line trigger.

The line to trigger on is set to the VITS line specified in the channel table. If no VITS line is specified, then line 17 is selected.

The **FREQ/MKRS** knob is assigned to video line. This lets you select the line to trigger on. Thus you can display any line in the field for viewing by using the knob.

To view line modulation, press **[CATV/APPL] [2]**. The center frequency is set to the visual carrier frequency of the selected channel, zero span is enabled, the sweep rate is set to 10  $\mu$ s/division, the resolution bandwidth is set to 5 MHz, and the readouts are turned off.

If a VITS line is specified in the channel table, you should see that VITS line. If a VITS line is not specified, then you should see line 17 of the video signal. If you wish to change the displayed line, press **[READOUT]** and turn the **FREQ/MKRS** knob to select the desired line, then turn off the readouts.

### NOTE

*The direction of the arrows always represents the direction of change of the 2714 setting. ([  ] adjacent to [REF LEVEL] increases the reference level and lowers the displayed signal height.)*

## Keypad Entry

As with frequency and span/div, you can directly enter the reference level from the keypad. This feature is especially handy when you have a good estimate ahead of time of what the signal amplitude is, or when you are simply interested in how much below a given amplitude a particular signal is. For instance, you might want to preset the reference level to +15 dBmV to examine cable TV signals at a customer drop.

To set the reference level to a predetermined value, press **[REF LEVEL]** to place the reference level in the immediate entry mode. Notice that the abbreviation REFL has appeared at left center of the 2714 screen. The REFL notation indicates that you can enter the reference level directly from the keypad. This is done by keying in a permissible value followed by an appropriate terminator key. You can enter any value from -21.2 to +68.8 dBmV (or the equivalent in other units). You can enter up to 25 characters, but regardless of how many you enter, the 2714 rounds and displays the reference level to a tenth of a dB.

Set the reference level to 21.3 dBmV by pressing **[2] [1] [.] [3] [Y]**. The numbers you type appear on screen to the right of REFL. If you make a mistake, you can correct it any time prior to pressing **[Y]** by repeatedly pressing **[BKSP]** until the incorrect number disappears, and then typing the correct value.

Pressing a terminator key (only **[Y]** or **[Z]** in this case) determines the units. The **[Y]** key can represent units of kHz,  $\mu$ SEC,  $\mu$ V, or +dBx. Because the reference level immediate entry mode requires decibels, and because the reference level unit is dBmV, the 2714 correctly interprets the currently displayed value as 21.3 dBmV when you press **[Y]**. If a frequency unit had been required, the 2714 would have interpreted your entry as 21.3 kHz when you pressed **[Y]**. On the other hand, had you wanted to enter a negative reference level, you would have pressed **[Z]** for -dBx. The 2714 ignores the **[W]** or **[X]** terminator keys because they do not represent acceptable reference level units.

**NOTE**

*You can print measurement results only when the RS-232 interface is installed in the 2714. The GPIB interface does not support the print function.*

*Be sure to select handshaking ([UTIL] [4] [0] [2] [5]) to match that expected by the printer or long jobs may not print completely.*

Press **[3]** to print results of the last measurement performed. A printer must be connected to the 2714.

Press **[4]** to print all stored results of the measurement. Again a printer must be connected to the 2714.

---

## Auxiliary Operations

The following auxiliary operations involve viewing a display. Each selection toggles the desired display on and off.

Press **[9]** repeatedly until page 2 of the CATV MEASUREMENTS menu [CATV MEASUREMENTS (PG 2)] is displayed. Note the following items in the menu.

- 1 VIEW MODULATION (FIELD)**
- 2 VIEW MODULATION (LINE)**
- 3 VIEW PICTURE**
- 4 LISTEN**

These features are selected by pressing the number that applies to each, and deselected by pressing the same number or pressing a number that applies to another feature.

### View Modulation (Field)

This operation allows you to view a full field of baseband modulation in the analog mode.

This operation is not available for FM, DATA, and PILOT signals.

If this current channel has scrambling on (as specified in the channel table), you are prompted to turn off scrambling before proceeding. The needed trigger modes will not work with scrambling.

## REF LVL STEP

The calibration signal peak is now less than one division below the reference level.

Press **[REF LVL STEP]**.

Nothing happened on screen, but the red LED next to the key lit. The LED indicates that the rate at which the reference level arrow keys change the on-screen signal height and reference level is now 1 dB per press rather than 10 dB. Press **[↔]** three times. The signal peak rises until it is just above the reference level, and the readout indicates 18.3 dBmV. You cannot get the signal peak closer to the reference level without entering a new reference level in the immediate entry mode.

Press **[↕]** ten times, and watch the signal peak drop to almost one division below the reference level. The reference level readout should indicate 28.3 dBmV.

**REF LVL STEP** is another toggle-action key. Press **[REF LVL STEP]** again. The LED goes out indicating that the reference level is back in 10 dB per press mode. Press **[↔]** and confirm that the reference level returns to 18.3 dBmV.

Reset the reference level to 38.8 dBmV.

## CATV Measurements

Press **[3]** to print the results of the last measurement performed. A printer must be connected to the 2714.

Press **[4]** to print the all the results of the measurement. Again a printer must be connected to the 2714.

You can get out of this measurement by pressing **[9]**.

### Running The Automatic Measurement

To run the measurement in the AUTO (PAUSE FOR TEST SIGNAL) mode, follow these steps.

1. Press **[5][1]** to select Auto mode. Auto Test Locations (Items 2 through 8) are added to the menu. These locations represent points relative to the visual carrier where measurements are to be made.
2. Press **[2]** and enter the first measurement location.
3. Press **[3]** and enter the second measurement location.
4. Press **[4]** and enter the third measurement location.
5. Press **[5]** and enter the fourth measurement location.
6. Press **[6]** and enter the fifth measurement location.
7. Press **[7]** and enter the sixth measurement location.
8. Press **[BKSP] [0]** to run the measurement.

The instrument measures the visual carrier peak for a reference, then measures the burst packet amplitudes.

Press **[CATV/APPL]** to display the IN-CHANNEL RESPONSE menu.

Press **[1]** to store the results of the last measurement. After a short period of time, the message RESULTS STORAGE COMPLETE is displayed.

Press **[2]** to display the results of the last measurement performed. A display resembling Figure 6-6 comes up. You can either view other previously stored results by pressing **[W]** or stop viewing the results by pressing **[Z]**.



## Running The Interactive Measurement

1. Press **[5] [0]** to select the Interactive mode.
2. Press **[BKSP] [0]** to run the measurement.

The instrument pauses and prompts you to enable a full-field test signal (Multiburst or Line Sweep). Replace the modulating video source with a full-field Multiburst signal or a full-field Line Sweep signal.

The instrument measures the visual carrier peak, then prompts you to move the marker to the first test location.

3. Use the **FREQ/MKRS** knob to move the marker to the first test location.
4. Press **[W]** to continue with the measurement.

The instrument measures the amplitude of the test signal at the marker location, then prompts you to move the marker to the second test location.

5. Press **[W]** to continue with the measurement.

Press **[CATV/APPL]** to display the IN-CHANNEL RESPONSE menu.

Press **[1]** to store the results of the last measurement. After a short period of time, the message **RESULTS STORAGE COMPLETE** is displayed.

Press **[2]** to display the results of the last measurement performed. A display resembling Figure 6-6 comes up. At this point you can choose to either go ahead and view other previously stored results by pressing **[W]** or stop viewing the results by pressing **[Z]**.

### NOTE

*You can print measurement results only when the RS-232 interface is installed in the 2714. The GPIB interface (option) does not support the print function.*

*Be sure to select handshaking (**[UTIL] [4] [0] [2] [5]**) to match that expected by the printer or long jobs may not print completely.*





# Enhanced Versatility

The first part of this section covered the fundamental controls of the 2714. This second part covers the remaining controls and how they enhance your ability to make accurate spectral measurements easily and conveniently. We cover how to control the resolution bandwidth, vertical scale factor, and sweep speed. We show how to use display storage and marker controls to quickly measure signal amplitude and frequency with maximum accuracy; and we show how to make direct spectral comparisons and to save important results for future reference in non-volatile RAM (NVRAM).

---

## RES BW

100.0MHz	(AUTO SWEEP)	ATTN 20DB
38.8DBMV		VF WIDE
20.0MHz/ 5MHz RBW (AUTO)		10 DB/ CALIBRATOR
	<i>Channel Table Name CH nn</i>	

The Res BW controls select the 2714 resolution bandwidths of 300 Hz to 5 MHz and allow time to be automatically selected to match the selected bandwidth.

Initialize instrument settings by pressing [UTIL] [1] [1], then set the 2714 parameters as follows to match the preceding settings box.

1. Set the center frequency to 100 MHz by pressing [CHAN/FREQ] [1] [0] [0] [X].
2. Set the span/div to 20 MHz by pressing [SPAN/DIV] [2] [0] [X].
3. Set the reference level to 38.8 dBmV by pressing [REF LEVEL] [3] [8] [.] [8] [Y].
4. Enable the calibrator by pressing [INPUT] [9].
5. Press [AUTO] to set the resolution bandwidth to 5 MHz.

measurement. The instrument then divides the difference between the two measurements by two and presents the quotient as the measurement result.

### Automatic Mode

For this mode, the IN-CHANNEL RESPONSE is usually measured at six locations where the first five burst packets of the multiburst test signal occur (-0.5 MHz, +0.5 MHz, + 1 MHz, +2 MHz, +3 MHz, and +3.58 MHz relative to the visual carrier). These locations are specified in the setup table (items 2 through 7 in the IN-CHANNEL RESP SETUP menu). If no locations are specified, the instrument uses the default locations.

### Starting The Measurement

Press CATV/APPL to call up the CATV MEASUREMENTS menu. See Figure 6-1.

Press [9] [5] to select the IN-CHANNEL RESPONSE measurement menu. This gives you the following options.

- 0 RUN IN-CHAN RESP
- 1 STORE CURRENT RESULTS
- 2 DISPLAY RESULTS
- 3 PRINT CURRENT RESULTS (*RS-232 Only*)
- 4 PRINT STORED RESULTS (*RS-232 Only*)
- 5 IN-CHAN RESP SETUP
- 9 LEAVE IN-CHAN RESP

To run the measurement in the Interactive mode, follow these steps.

#### NOTE

*Be aware that this test will interrupt the current program material.*

To minimize the time during which the program will be disrupted, it is recommended that you have a test signal generator warmed up and connected to the on-line switcher.

6. Disable the markers by pressing [MKR/Δ/OFF] twice.

## Arrow Keys

Up until now, resolution bandwidth has been left in the AUTO mode which enables you to make measurements without worrying about where the resolution bandwidth is set. The 2714's default is a fixed resolution bandwidth of 300 kHz. AUTO mode is available, but it is not the normal operating mode. There are circumstances in which you will want to control the resolution bandwidth yourself. For instance, if you look at the time domain representation of a TV video signal using zero span, you will want to use the 5 MHz (maximum bandwidth) filter to ensure enough bandwidth for the video signal. In other cases you may wish to select a very narrow resolution bandwidth in order to resolve signal sidebands or intermodulation distortion products. The RES BW arrow keys enable you to select resolution bandwidths of 300 Hz, 1 kHz, 3 kHz, 10 kHz, 30 kHz, 100 kHz, 300 kHz, 1 MHz, and 5 MHz in the 2714.

It is important to know how far signals have to be separated before we can see them as separate. The answer depends on the particular filters, bandwidths, signal levels and other factors, but the following rules apply.

- If the signal amplitudes are less than 3 dB different, they are resolved when their frequency separation equals the resolution bandwidth.
- For signals more widely separated in amplitude and frequency, let A be the amplitude difference. Then

$$F = \left(1 + \frac{A}{22}\right) \times \text{resolution BW}$$

where F is the required frequency separation. This rule is based on the fact that the 2714's 60 dB filter bandwidths tend to be approximately 7 times the 6 dB bandwidth and assumes the filter roll-off is approximately linear in dB. Using this condition, if the signals are 30 dB different in amplitude (A) then they have to be separated by approximately 2.4 x resolution BW.

Set the span to 2.0 MHz/div. The resolution bandwidth readout indicates 300 kHz. Change the resolution bandwidth by pressing [  ] in the RES BW function block.

---

## In-Channel Response Measurement

There are two methods of making this measurement: Interactive and Automatic with Pause for Test Signal mode. Select the measurement mode from the IN-CHAN RESP SETUP menu before initiating the test. The Interactive mode is intended to assist you in selecting the measurement points (two). The automatic mode is intended to allow measurement levels at up to five locations that are entered using the IN-CHAN RESP SETUP menu.

Regardless of which measurement mode is selected, you will be prompted to replace the modulating signal with a test signal.

When the measurement is initiated, the instrument does the following.

- Enables peak acquisition mode
- Sets the reference level so that the peaks of the detected test signal are placed in the top major division while the instrument is in the 10 dB/div mode
- Sets the vertical mode to 1 dB/div
- If the test signal is Multiburst, the instrument prompts you to move the marker to the lowest detected burst packet and press **[W]** to make the first measurement; if the test signal is Line Sweep, the instrument prompts you to move the marker to the lowest point in the detected sweep and press **[W]** to make the first measurement
- If the test signal is Multiburst, the instrument prompts you to move the marker to the highest detected burst packet and press **[W]** to make the second measurement; if the test signal is Line Sweep, the instrument prompts you to move the marker to the highest point in the detected sweep and press **[W]** to make the second measurement — the instrument then calculates the difference between the two measurements and divides the difference by two, and presents the quotient as the measurement result

### Interactive Mode

For the Interactive mode, the IN-CHANNEL RESPONSE is measured at two locations that are selected by placing a marker at the lowest point in the channel response and taking a measurement, then moving the marker to the highest point in the response and taking another

Notice that the noise floor increases approximately 12 dB as you switch from 300 kHz resolution bandwidth to 5 MHz. The reason for this rise in the noise floor is that the noise coming through a filter is proportional to the filter bandwidth. A wide filter passes more white noise components (frequencies) than a narrow filter. Consequently, more noise comes through a 5 MHz filter than through a 300 kHz filter.

The LED below the **RES BW AUTO** key went out indicating that the resolution bandwidth is no longer being automatically selected, and the resolution bandwidth readout indicates 5 MHz. The calibration signal now appears to be 5 MHz wide. Theoretically, the calibration signal should be infinitely narrow — a spike at 100 MHz.

To understand what has happened, you must recall the process going on within the 2714. It is sweeping a narrow-band signal (the calibration signal) past a broadband filter (the 5 MHz resolution filter). As the signal is moved past the filter, it maps the shape of the resolution filter. What you see is the spectral shape of the filter rather than that of the calibration signal. This means that on unmodulated signals a resolution bandwidth filter that is too wide can artificially broaden the displayed spectrum (although the signal peak remains accurate).

Narrow the resolution bandwidth by repeatedly pressing [  ] in the RES BW function block until the on-screen readout indicates 3 kHz. There is a high-level beep and the message UNCAL (if there is no beep, check that the audio alert is set to ERROR ONLY or BOTH — see The Audio Alert in Section 7). The 2714 is now sweeping the calibration signal past the resolution filter too quickly for the filter output to rise to its steady-state value before the signal is no longer present at the filter input. This can result in low amplitude and skewed frequency readings. This means that a resolution bandwidth that is too narrow can result in incorrect amplitude and skewed frequency measurements. Measurement accuracy is compromised when the UNCAL message is present.

## AUTO

Pressing [AUTO] in the RES BW function block toggles between manual and automatic selection of the resolution bandwidth. When the resolution bandwidth is being selected automatically by the 2714, the LED below the key is lit.

Place the resolution bandwidth in the automatic mode by pressing [AUTO]. The red LED will be illuminated. You can take the 2714 out of AUTO mode by pressing a RES BW arrow key or by pressing [AUTO].

Turn off the carrier and press **[W]** to continue (or **[Z]** to abort) the measurement.

The instrument measures the Cross Modulation and displays the result.

Press **[CATV/APPL]** to display the CROSS MODULATION menu.

Press **[1]** to store the results of the last measurement. After a short period of time, the message RESULTS STORAGE COMPLETE is displayed.

Press **[2]** to display results of the last measurement performed. You can either view other previously stored results for this measurement by pressing **[W]**, or stop viewing the results by pressing **[Z]**.

Press **[3]** to print the results of the last measurement performed. A printer must be connected to the 2714.

### NOTE

*You can print measurement results only when the RS-232 interface is installed in the 2714. The GPIB interface does not support the print function.*

*Be sure to select handshaking (**[UTIL] [4] [0] [2] [5]**) to match that expected by the printer or long jobs may not print completely.*

Press **[4]** to print the last stored results of the measurement. A printer must be connected to the 2714.

Press **[9]** to leave the Cross Modulation measurement and return to the CATV MEASUREMENTS menu.

## Enhanced Versatility

Set the span/div to 50 MHz. Note the indicated resolution bandwidth and press [  $\blacktriangleleft$  ] in the **RES BW** function block. The LED goes out, and the resolution bandwidth goes to 300 kHz.

Press [ **AUTO** ]. The LED comes back on and the resolution bandwidth is switched back to 5 MHz.

Press [ **AUTO** ] again. The LED goes out, but the resolution bandwidth is still 5 MHz. Toggling out of the **AUTO** mode with [ **AUTO** ] maintains the automatically selected resolution bandwidth until you change it with a **RES BW** arrow key.

---

## VIDEO FILTER

700.0MHz	(AUTO SWEEP)	ATTN 20DB
28.8DBMV		VF WIDE
50.0MHz/		10 DB/
5MHz RBW (AUTO)		<i>Channel Name CH nn</i>
		CALIBRATOR

A video filter is a post-detection filter (sometimes referred to as a noise-averaging filter) used to reduce noise in the displayed spectrum to its average value, making low-level signals more easily detectable. Normally, the 2714 uses a video filter about as wide as the resolution bandwidth. This limits post-detection noise, but does not significantly alter the displayed amplitude of narrow-band signals. However, if you must measure very wideband or pulse-like signals, you may wish to use a filter somewhat wider than that automatically selected by the 2714. See Menu-Entered Control Settings in Section 7.

The video filter width is indicated in the on-screen readouts by VF bandwidth, where bandwidth is equal to the bandwidth of the video filter being used. This is true except in the case of the 5 MHz or the 1 MHz filter where the **WIDE** video filter is automatically selected. You can select **WIDE** video filter for any resolution bandwidth.

When you press [ **VID FLTR** ], the 2714 automatically selects a narrower video filter bandwidth approximately 1/100 of the resolution BW (specifying particular filter bandwidth using the **UTIL** menu is described later in this section). The narrow video filter dramatically reduces the noise and enhances the visibility of narrow-band signals.

---

## CROSS MODULATION Measurement

This routine measures and records the cross modulation in the current channel relative to an unmodulated visual carrier.

When the CROSS MODULATION measurement is initiated, the 2714 measures the peak level of the visual carrier in the current channel and prompts you to turn off the modulation on the current channel.

The 2714 then centers the carrier, sets the acquisition mode to peak, moves the carrier to the top of the screen, sets the vertical mode to linear, and enables zero span. The sweep speed is set to 100  $\mu\text{s}/\text{div}$  and **FINE REF LEVEL STEP** is enabled. The maximum point on the screen is found and the reference level is incremented as necessary to ensure that the maximum point on the waveform is on the screen.

The cross modulation is computed as  $20 \log_{10} (15.7 \text{ kHz}/\text{Peak})$ . This is the ratio of the 15.7 kHz component of modulation relative to the peak of the carrier.

### NOTE

*If the NCTA-recommended procedure is followed using synchronous square-wave modulation on all other channels, the number displayed should be increased by 3.9 dB to express the peak-to-peak value of the square wave.*

Press **[CATV/APPL]** to call up the CATV MEASUREMENTS menu. See Figure 6-1.

### Enable CROSS MODULATION Measurement

Press **[2]** to select the CROSS MODULATION measurement menu. This gives you the following options.

- 0 RUN CROSS MODULATION**
- 1 STORE CURRENT RESULTS**
- 2 DISPLAY RESULTS**
- 3 PRINT CURRENT RESULTS (RS-232 Only)**
- 4 PRINT STORED RESULTS (RS-232 Only)**
- 9 LEAVE CROSS MODULATION**

Press **[0]** to run the Cross Modulation measurement.

The instrument prompts you to turn off the carrier.



noise and enhances the visibility of narrowband signals. Care must be taken, though, because it will also reduce the indicated amplitudes of wideband signals such as video modulation and short duration pulses.

To see the video filter work, ensure that the 2714 is set as in the preceding settings box, and note if the signal peaks at 700 MHz, 800 MHz, and 900 MHz are visible.

Press **[VID FLTR]**. The red LED below the key comes on indicating that a narrow video filter is being used, and the bandwidth of the filter is indicated on screen.

Notice how much less noisy the lower portion of the spectral display appears. By filtering the noise, it is sometimes possible to reveal low-level signals that are in the noise. This is the primary reason for using a video filter. The signal peaks at 700 MHz, 800 MHz, and 900 MHz (the seventh, eighth, and ninth harmonics of the calibration signal) should now be visible. There are small differences from instrument to instrument, but you should be able to spot the peaks above the noise.

Video filtering works well for continuous wave and other narrowband signals, but when examining pulsed or wideband signals such as television video (especially the sync pulses), a video filter may prevent you from accurately seeing signal characteristics in much the same way that using a resolution bandwidth that is too narrow does.

Although it may not have been apparent, the sweep speed also decreased in order to accommodate the longer time constant of the video filter. Just as with the resolution bandwidth filter, a signal needs more time to reach its peak amplitude when propagating through a narrow video filter.

Toggle the video filter off by pressing **[VID FLTR]** again.

## CATV Measurements

The instrument then makes a sweep within these constraints, and prompts you to turn on the carrier.

9. Turn on the carrier and press **[W]** to continue (or **[Z]** to abort) the measurement.

The instrument searches the single-sweep record for beats within  $\pm 50$  kHz of offset locations specified in the test table and displays the worst case result.

Press **[CATV/APPL]** to display the CTB/CSO menu.

Press **[1]** to store the results of the last measurement. After a short period of time, the message RESULTS STORAGE COMPLETE is displayed.

Press **[2]** to display results of the last measurement performed. A display resembling Figure 6-6 comes up. You can either view other previously stored results by pressing **[W]**, or stop viewing the results by pressing **[Z]**.

Press **[3]** to print the results of the last measurement performed. A printer must be connected to the 2714.

### NOTE

*You can print measurement results only when the RS-232 interface is installed in the 2714. The GPIB interface does not support the print function.*

*Be sure to select handshaking (**[UTIL] [4] [0] [2] [5]**) to match that expected by the printer or long jobs may not print completely.*

Press **[4]** to print all stored results of the measurement. A printer must be connected to the 2714.

Press **[9]** to exit this mode or continue to the next measurement mode.

---

## VERT SCALE

The Vert Scale controls select from the available logarithmic vertical scale factors or convert to the linear mode.

100.0MHz	(AUTO SWEEP)	ATTN 6DB
23.8DBMV		VF WIDE
20.0MHz/		10 DB/
5MHz RBW (AUTO)		<i>Channel Name CH nn</i>
		CALIBRATOR

### 10/5/1

The **VERT SCALE** function block contains a three-way toggle key labeled **10/5/1**. This label expresses the three logarithmic vertical scale factors available on the 2714; 10, 5 and 1 decibels per major vertical division. Press the key to cycle the vertical scale factor through the three values in a 10 dB – 5 dB – 1 dB – 10 dB ... sequence.

Press [**10/5/1**] and two things happen. First, the signal peak is now one division down from the reference level. Second, the vertical scale factor readout now indicates 5dB/. The noise also seems to have disappeared; the signal-to-noise difference is the same, but the scale factor change has moved the noise below the bottom of the screen.

Press [**10/5/1**] again. The signal peak is now five divisions down and the readout says 1 dB/. The primary use for this feature is to more accurately read displayed signal peaks. Press the key once again to restore the 10dB/ setting.

### LIN

The second key in the **VERT SCALE** function block is also toggle-action. It converts the vertical scale from logarithmic to linear and back again.

With the calibration signal centered and the reference level set to 23.8 dBmV, press [**LIN**]. The vertical scale readout now indicates 1.94mV/. When the **LIN** mode is initially selected, the 2714 converts the vertical scale so the bottom graticule line is 0 V and the scale factor is converted from dB to volts. The display is similar to what you see on an oscilloscope. Thereafter, the **REF LEVEL** arrow keys change the

**NOTE**

*You can print measurement results only when the RS-232 interface is installed in the 2714. The GPIB interface does not support the print function.*

*Be sure to select handshaking ([UTIL] [4] [0] [2] [5]) to match that expected by the printer or long jobs may not print completely.*

Press **[4]** to print all stored results of the measurement. A printer must be connected to the 2714.

Press **[9]** to exit this mode or continue to the next measurement mode.

To run the measurement in Single-sweep mode, follow these steps.

1. Press **[5] [3]** to select the Single-sweep mode. The Auto Test Location choices (items 4 through 8) are added to the menu. These locations represent points where beats are expected to occur relative to the visual carrier.
2. Press **[4]** and enter the first beat location as an offset from the visual carrier.
3. Press **[5]** and enter the second beat location.
4. Press **[6]** and enter the third beat location.
5. Press **[7]** and enter the fourth beat location.
6. Press **[8]** and enter the fifth beat location.
7. Press **[BKSP] [0]** to run the measurement.

The instrument measures the visual carrier peak for a reference, then prompts you to turn off the carrier.

8. Turn off the carrier and press **[W]** to continue (or press **[Z]** to abort) the measurement.

SINGLE SWEEP mode searches the Auto Test table for the lowest and highest frequencies relative to the visual carrier, and sets the instrument's span/div and center frequency to sweep from 0.25 MHz below the lowest frequency to 0.25 MHz above the highest frequency.

scale factor in a 1–2–5 sequence. Consequently, the reference level changes by 6 or 8 dB when changing scale factors. If the **FINE** reference level step size is selected while in the **LIN** mode, the arrow keys change the scale factor at a rate of approximately 0.02 division per step and the corresponding reference level changes approximately 0.2 dB.

Experiment with the scale factor by pressing [**LIN**] to toggle back to logarithmic mode. When switching back to logarithmic from linear, the last selected log scale is implemented.

---

## SWEEP

100.0MHz	(AUTO SWEEP)	ATTN 0DB
-21.2DBMV		VF 3KHz
50.0KHz/		10 DB/
10KHz RBW (AUTO)		

The SWEEP function block controls the 2714 normal sweep rate, auto sweep, and single sweep feature (other trigger modes are discussed in Section 7 under **SWP/TRIG**). The rate at which the CRT beam sweeps across the screen is known as the sweep rate. It is also the rate at which the displayed spectrum is swept.

### Arrow Keys

Normally, sweep rate is automatically selected by the 2714. However, in some cases, such as when looking at the time domain representation of a signal in zero span, you may want to vary the sweep rate for a better view of the signal.

Ensure that the calibrator is turned off, and enter the zero span mode.

The currently selected sweep rate is displayed on screen as the horizontal scale factor in zero span mode and has units of time/division (in the spectral mode, view the sweep rate by pressing [**SWP/TRIG**]). The sweep rate readout indicates 50MS/ZSPAN (50 msec/div in zero span) and the internal noise is displayed. Now

## CATV Measurements

Press **[4]** to print all stored results of the measurement. A printer must be connected to the 2714.

To run the measurement in the Automatic mode with Pause for Carrier Off, follow these steps.

1. Press **[5] [2]** to select the Automatic mode with Pause for Carrier Off. The Automatic Test Location choices (Items 4 through 8) are added to the menu. These locations represent points where beats are expected to occur relative to the visual carrier.
2. Press **[4]** and enter the first beat location as an offset from the visual carrier.
3. Press **[5]** and enter the second beat location.
4. Press **[6]** and enter the third beat location.
5. Press **[7]** and enter the fourth beat location.
6. Press **[8]** and enter the fifth beat location.
7. Press **[BKSP] [0]** to run the measurement.

The instrument measures the visual carrier peak for a reference, then prompts you to turn off the carrier.

8. Turn off the carrier and press **[W]** to continue (or **[Z]** to abort) the measurement over the spectral display.

The instrument measures the beats within 250 kHz of each offset location, then displays the worst case result with the spectral display.

Press **[CATV/APPL]** to display the CTB/CSO menu.

Press **[1]** to store the results of the last measurement. After a short period of time, the message RESULTS STORAGE COMPLETE is displayed.

Press **[2]** to display results of the last measurement performed. A display resembling Figure 6-6 comes up. You can either view other previously stored results by pressing **[W]**, or stop viewing the results by pressing **[Z]**.

Press **[3]** to print the results of the last measurement performed. A printer must be connected to the 2714.

## Enhanced Versatility

Continue pressing [  $\blacktriangledown$  ] until the sweep rate readout changes to 1MS/ZSPAN. The SWEEP down arrow key decreases the sweep rate in a 1–2–5 sequence.

The noise no longer looks like grass. Variations in the noise waveform can be seen occurring in a millisecond or less. Even faster sweep rates are possible (1  $\mu$ sec/div) with display storage disabled.

Now press [  $\blacktriangle$  ] several times. The noise is compressed to a grass-like appearance and the indicated sweep rate increases. The SWEEP [  $\blacktriangle$  ] key increases the sweep rate in a 1–2–5 sequence.

The [  $\blacktriangledown$  ] and [  $\blacktriangle$  ] keys perform reciprocal actions; they decrease or increase the time required to sweep one division. Pressing either key removes the 2714 from the automatic sweep rate selection mode, and [  $\blacktriangle$  ] or [  $\blacktriangledown$  ] thereafter function like the sweep rate selector on a conventional oscilloscope.

### NOTE

*Because sweep rate is the inverse of sweep speed, decreasing sweep rate increases sweep speed.*

Reset the sweep rate to 50 msec/div and the span/div to 50 kHz. Set the reference level to 38.8 dBmV and turn on the calibrator. Reduce the time/div by repeatedly pressing [  $\blacktriangledown$  ].

A beep sounds and the word UNCAL appears.

Continue to increase the sweep speed, and notice the signal peak decrease and shift to the right.

This condition occurs when sweeping too fast for a given resolution BW and demonstrates how measurement errors can occur. The resolution filter is sweeping so fast that its output does not have time to reach steady-state. Reselect **ZERO SPAN**. The UNCAL message disappears, because in the zero span mode the filter is not being swept at all.

Reset the displayed sweep speed to 1 msec/div.

2. Press **[4]** and enter the first beat location as an offset from the visual carrier.
3. Press **[5]** and enter the second beat location.
4. Press **[6]** and enter the third beat location.
5. Press **[7]** and enter the fourth beat location.
6. Press **[8]** and enter the fifth beat location.
7. Press **[BKSP] [0]** to run the measurement.

The instrument measures the visual carrier peak for a reference, then sets the span/div setting such that the measurements are made over a 0.25 MHz span on either side of the frequency offset position.

The instrument measures the first, second, third, fourth, and fifth beats.

Out of the five locations measured or after the routine is aborted, the instrument displays the worst case result (in the spectral display).

Press **[CATV/APPL]** to display the CTB/CSO menu.

Press **[1]** to store the results of the last measurement. After a short period of time, the message RESULTS STORAGE COMPLETE is displayed.

Press **[2]** to display results of the last measurement performed. A display resembling Figure 6-6 comes up. You can either view other previously stored results by pressing **[W]**, or stop viewing the results by pressing **[Z]**.

Press **[3]** to print the results of the last measurement performed. A printer must be connected to the 2714.

### NOTE

*You can print measurement results only when the RS-232 interface is installed in the 2714. The GPIB interface does not support the print function.*

*Be sure to select handshaking (**[UTIL] [4] [0] [2] [5]**) to match that expected by the printer or long jobs may not print completely.*



## AUTO

The **AUTO** key in the **SWEEP** function block serves two purposes. First, it is used in much the same way as the **AUTO** key in the **RES BW** function block — as a toggle-action key that switches the 2714 between automatic and manual selection of sweep rate. When **AUTO** sweep rate selection is active, the sweep rate selected by the 2714 depends on the span/div, resolution bandwidth, and video filter in use. Second, pressing the **SWEEP AUTO** key when the 2714 is in the single sweep mode exits from that mode.

Continuing with the previous example, press **[ZERO]** to exit the zero span mode. Notice how distorted the calibration signal is and then press **[AUTO]** in the **SWEEP** function block.

The LED below the key lights indicating that the sweep rate is being automatically selected by the 2714. The sweep rate is now 50 msec/div, the **UNCAL** message has disappeared, and the calibration signal is correctly indicated as 18.8 dBmV at 100 MHz.

Again, press **[AUTO]** in the **SWEEP** function block.

The LED goes out but the display does not change. Toggling out of the **AUTO** mode maintains the automatically selected rate until you change it with **[▲]** or **[▼]**.

Reactivate the **AUTO** sweep mode.

## SINGLE SWEEP

100.0MHz	(AUTO SWEEP)	ATTN 20DB
38.8DBM		VF 300KHz
1.0MHz/		10 DB/
300KHz RBW (AUTO)		

The 2714 is equipped with a single-sweep feature. When activated by pressing **[SINGLE]**, the 2714 makes only one sweep. Other controls (except **AUTO** in the **SWEEP** function block) operate normally, and signals at the input to the 2714 are treated just as they would be otherwise. Pressing **[AUTO]** in the **SWEEP** function block exits from the single sweep mode.

**NOTE**

*You can print measurement results only when the RS-232 interface is installed in the 2714. The GPIB interface does not support the print function.*

*Be sure to select handshaking ([UTIL] [4] [0] [2] [5]) to match that expected by the printer or long jobs may not print completely.*

Press [4] to print the all results of the measurement. A printer must be connected to the 2714.

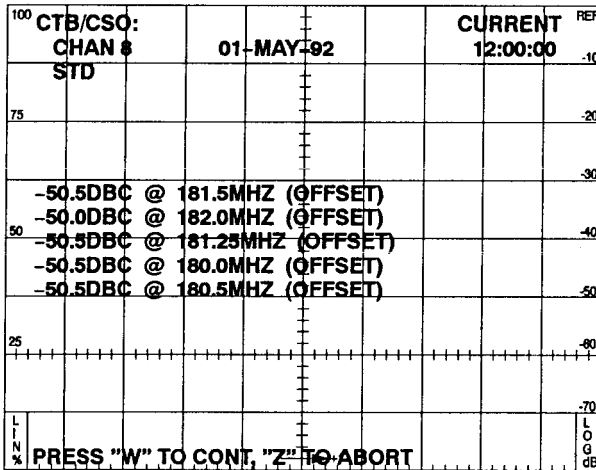

**Figure 6-6: Typical CTB/CSO Measurement Results Display**

Press [9] to exit this mode or continue to the next measurement mode.

To run the measurement in the Automatic mode, follow these steps.

1. Press [6] [1] to select Automatic mode. Auto Test Locations (Items 4 through 8) are added to the menu. These locations represent points where beats are expected to occur relative to the visual carrier.

## Enhanced Versatility

When a sweep begins will depend on how the 2714 is triggered. The factory default mode is free run; this is the mode the 2714 currently should be in.

Set the resolution BW to 3 kHz. The sweep now takes two seconds. At mid-sweep, press **[SINGLE]**.

The current sweep is aborted and the message SGLSWP MODE appears on-screen under the right readout column. The message means the sweep circuit is in the single sweep mode and halted. Press **[SINGLE]** again. This prepares the sweep to begin as soon as it receives the next trigger signal (which occurs automatically in the free-run mode). A message reading SGLSWP ARM momentarily appears and a single sweep is carried out. The sweep will progress across the screen as a new spectral display is created. When the sweep is completed, the SGLSWP MODE message reappears indicating the 2714 has completed the sweep and is ready to be re-armed.

If the 2714 is not in the free-run trigger mode (see SWP/TRIG in Section 7 to change modes), behavior is much the same.

Pressing **[SINGLE]** causes the current sweep to abort and the SGLSWP MODE message to appear. If you press the key again, the SGLSWP ARM message appears. This time, however, the 2714 waits for the first designated trigger signal; when detected, a single sweep begins. After the sweep is complete, the SGLSWP MODE message reappears.

You can start a new single sweep in any trigger mode as often as you wish by pressing **[SINGLE]** after the SGLSWP MODE message appears.

To exit from the single-sweep mode, press **[AUTO]** in the **SWEEP** function block.

The single-sweep mode is useful when you want to prevent a succeeding sweep from overwriting a trace you just acquired or to capture the characteristics of intermittent signals.

---

## LEVEL

There is a dual-concentric-shaft **LEVEL** control below the **FREQ/MKRS** knob. The inner knob controls the triggering level when the 2714 is in internal, external, or line trigger modes, just as the equivalent

4. Use the **FREQ/MKRS** knob to place the first beat on a graticule line. Make a note of this graticule line.
5. Press **[CATV/APPL] [6]** to enable the Digital display, and move the marker to the graticule line noted in the preceding step.
6. Press **[W]** to continue with the measurement.

At the end of the measurement, the instrument displays the results and prompts you to move the marker to the second beat.

7. Repeat steps 3 through 6 for the second, third, fourth, and fifth beats, or press **[Z]** to quit at any prompt.

### **NOTE**

*If you decide to quit in the middle of the measurement, all measurement results up to that point will be retained in a temporary buffer.*

*You can then decide to save those results using the **STORE CURRENT RESULTS** selection or ignore (discard) them.*

*You can also view those results with the **DISPLAY RESULTS** selection.*

Each time a measurement is made, the instrument displays the worst case result up to that point.

Press **[CATV/APPL]** to display the CTB/CSO menu.

Press **[1]** to store the results of the last measurement. After a short period of time, the message **RESULTS STORAGE COMPLETE** is displayed.

Press **[2]** to display the results of the last measurement performed. A display resembling Figure 6-6 comes up. At this point you can choose to either go ahead and view other previously stored results by pressing **[W]**, or stop viewing the results by pressing **[Z]**.

Press **[3]** to print the results of the last measurement performed. A printer must be connected to the 2714.

control does on a conventional oscilloscope. It also controls the horizontal sweep position in the manual scan mode. It has no effect in the other trigger modes.

The outer knob controls the volume of the AM and FM demodulators and picture framing in video monitor mode.

Alternate uses of the **LEVEL** control are discussed under **DEMOD** and **Manually Scanning** in Section 7.

---

## DISPLAY STORAGE

The 2714 can display an analog spectrum of up to four sampled and stored digital spectra. A major advantage of display storage is that it results in a flicker-free sweep.

<b>100.0MHz</b>	<b>(AUTO SWEEP)</b>	<b>ATTN 20DB</b>
<b>38.8DBM</b>		<b>VF 300KHz</b>
<b>5.0MHz/</b>		<b>10 DB/</b>
<b>300KHz RBW (AUTO)</b>		<b>CALIBRATOR</b>

### Display Registers

The digital display storage registers are named A, B, C, and D. Their status is controlled by the **[A]**, **[B]**, **[C]**, and **[D]** keys; the red and green LEDs below each key indicate the status of the corresponding register. When a red LED is lit, the contents of the corresponding register are displayed. The contents of a register can be either the measurement currently being carried out or previously saved data.

When only a red LED is lit, the register contents are the result of the 2714's current activity. Current results are updated from the signal at the 2714 input during each sweep. The present control settings are used for the update.

When an A, B, or C green LED is lit, the corresponding register contains a saved sweep (the on-screen readouts are saved along with the sweep). A saved sweep cannot be erased, modified, or updated without operator interaction.

When the D green LED is lit, the 2714 is in the "waterfall" mode.

## CATV Measurements

In this mode, the instrument scans the signals at locations specified in the setup table relative to the carrier frequency. Absolute locations are ignored. If no locations are specified, the instrument uses the default locations. From these it creates a single-sweep test table. It then computes sweep limits that include all the frequencies found in the single-sweep table (with 250 kHz of oversweep at each end). It takes a single sweep using a 30 kHz RBW and no video filter. It checks each of the locations in the single-sweep test table to see that the signals there are neither too near the bottom of the screen or too near the top for a safe measurement. If necessary, it adjusts the reference level to ensure that the measurement can be made safely. It then turns on the 100 Hz video filter and sweeps again. It now prompts you to turn the carrier back on and proceeds to measure all the beats specified in the single-sweep test table using the single sweep data.

Press **[CATV/APPL]** to call up the CATV MEASUREMENTS menu.  
See Figure 6-1.

### Enable CTB/CSO Measurement

Press **[9] [5]** to select the CTB/CSO measurement menu. This gives you the following options.

- 0 RUN CTB/CSO**
- 1 STORE CURRENT RESULTS**
- 2 DISPLAY RESULTS**
- 3 PRINT CURRENT RESULTS (RS-232 Only)**
- 4 PRINT STORED RESULTS (RS-232 Only)**
- 5 DIGITAL/ANALOG**
- 6 CTB/CSO SETUP**
- 9 LEAVE CTB/CSO**

To run the measurement in the Interactive mode, follow these steps.

1. Press **[5] [0]** to select the Interactive mode.
2. Press **[BKSP] [0]** to run the measurement.

The instrument measures the visual carrier peak, then prompts you to move the marker to the first beat.

3. Since it might be easier to visually detect beats in the analog mode, press **[CATV/APPL] [6]** to enable the Analog display with short holdoff.

**[A]**, **[B]**, **[C]**, and **[D]** are toggle-action keys that activate and deactivate the display registers. A register's contents are displayed only when it is active (red LED lit), although it still contains saved data as long as its green LED is lit.

Turn on the C register by pressing **[C]**.

The only change that might be apparent is an increase in intensity since the 2714 is now displaying the C trace on top of the D trace.

Now turn on the A and B registers by pressing **[A]** and **[B]**.

There may be an increase in intensity, but the shape of the spectral display should not change, because each register contains exactly the same information. Deactivate the B, C, and D registers by pressing **[B]**, **[C]**, and **[D]**.

This display is no different than the D register waveform. Verify this by turning on the D register and turning off A (press **[D]** and then **[A]**). Verify that this is true of the other registers by alternately switching a new one on and the previous one off.

**Analog Display** — Deactivate all registers to display the analog output of the 2714. Note its similarity to the MAX/MIN display. Any time all four red LEDs are extinguished, the analog output of the 2714's detector is displayed. The digitizer is still working; you have just disabled all the display registers. The analog display can be very useful for viewing time-varying modulation such as television video signals. It is also useful if you are used to a spectrum analyzer that may not have digital display capabilities; since it provides a display you are familiar with and allows you to see the similarity between the MAX/MIN display and the analog signal. You can usually obtain a crisper analog display, especially at higher sweep speeds, by varying the intensity (see INTENSITY at the end of this section) and/or turning off the on-screen readouts.

Activate the D register.

## SAVE ENABLE

**A, B, C Registers** — The **SAVE ENABLE** key modifies the function of the **[A]**, **[B]**, **[C]**, and **[D]** keys. When used with **[A]**, **[B]** or **[C]** key, it enables you to save the current digitizer output in the corresponding register.

## Interactive Mode

First, the instrument measures the peak of the video carrier on the current channel.

If the mode is interactive, you will be prompted to move the marker to the first beat to be measured. You may make any changes to the instrument setup to locate beats, including going into the analog mode. You can use 6 in the CTB/CSO menu to toggle between the digital and analog modes. You must make sure the marker is re-enabled before the beat is measured. Toggling the digital mode on turns on the marker. (The marker can be enabled only in digital mode.) Press **[W]** to measure the beat and **[Z]** to quit measuring.

To measure the beat, the instrument returns to the specified frequency, sets the instrument to NCTA-recommended settings (span at 50 kHz, RBW to 30 kHz, and video filter to 10 Hz). The 2714 may adjust the reference level so that the reading is at least one division from the bottom of the screen to minimize logging errors. It then searches for the maximum value within two divisions (100 kHz) of the specified frequency and returns this as the measurement.

After 5 beats have been measured, or **[Z]** is pressed, the instrument returns to the spectral display.

## Automatic Mode

In the Automatic mode, the instrument measures the level of the signals at locations specified in the setup table. Up to five (5) locations can be specified. For each table entry, the instrument measures the beat using the same settings as specified for the interactive case.

## Automatic With Pause Mode

The Automatic With Pause mode is identical to the Automatic mode except that after measuring the video carrier, the instrument pauses and prompts you to turn off the carrier.

## Single-sweep Mode

The Single-sweep mode is designed to minimize the time that the carrier must be turned off.

First, the instrument measures the peak of the video carrier on the current channel, then pauses and prompts you to turn off the carrier.



**NOTE**

*The CATV mode assumes full control of the waveform storage registers. Therefore, waveforms stored manually will be erased when CATV mode is activated at power-up, during a reboot cycle ([UTIL] [5] [0] [9]), or when it is reactivated after having been disabled.*

To manually save a waveform, press **[SAVE ENABLE]**. The red LED below **SAVE ENABLE** lights. This indicates that the SAVE function is armed.

To save into the A register what is presently being displayed, press **[A]**. The green LED below **[A]** lights, but observe that the A register was turned off and remains turned off. Turn off the D register and turn on the A register. Notice that the display does not change with time. The contents of the A register are not being updated. You are viewing a saved sweep.

Now save something into the B register. Activate the B register and ensure the A register is turned off. Set the resolution bandwidth to 30 kHz. Press **[SAVE ENABLE] [B]**.

The current sweep is saved and the B green LED lights. The register remains active, but because it is now saved, it is no longer updated.

**NOTE**

*Status of the red **[WWW]** is not changed by the save operation.*

Deactivate all registers (all red LEDs extinguished). Set the resolution bandwidth to 5 MHz and press **[SAVE ENABLE] [C]**. The C green LED lights. Activate the C register, and the digitized and saved version of the analog sweep is displayed. The digitizer is continuously updated, whether it is being displayed or not. Further, it is always the current digitizer output that is saved. You cannot, for instance, save one register into another. However, non-volatile RAM does make it possible to permanently save the contents of the display registers by transferring them to stored settings registers (see Other User-defined Settings in Section 7).

## CTB/CSO Measurement

There are four methods for making this measurement: Interactive, Automatic, Automatic With Pause-for-Carrier-Off, and Single-sweep mode. Select a mode in the CTB/CSO Setup menu before initiating the test. Interactive mode is intended to assist you in searching for beats. The automatic modes are intended to let you measure beats when you already know where they occur.

For the Automatic, Automatic with Pause-for-Carrier-Off, and Single-sweep mode, CSO is usually measured at  $\pm 0.75$  MHz and CTB at 0 MHz offset for a Standard Table. CTB can be viewed between channels 4 and 5 on the Standard Table.

Regardless of the mode selected, the first step is to measure the peak level of the visual carrier in the current channel. This is the reference level that all subsequent measurements are referred to.

Up to 5 beats are measured. The results are presented in terms of dBc relative to the carrier level measured at the beginning.

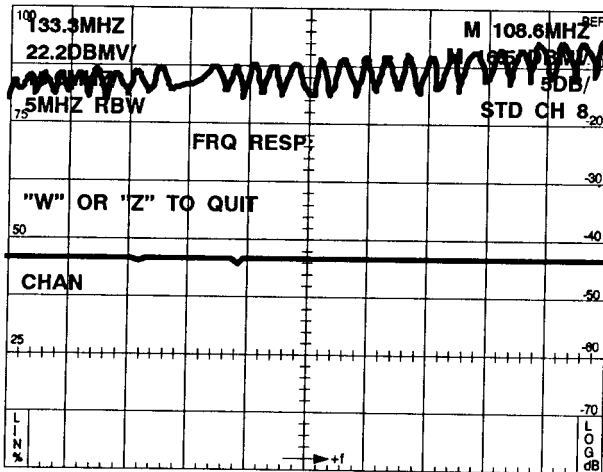

Figure 6-5: Typical Frequency Response Display With Reference

## Enhanced Versatility

To deactivate the C register and activate A, press **[SAVE ENABLE [A]]**. The A green LED goes out indicating there is nothing stored in the A register. The register remains active, but the displayed spectrum is now updated during each sweep.

**Register Priority** — The on-screen readouts are stored along with the sweep. Since the 2714 displays only one group of readouts at a time, the readouts for the highest priority register are displayed when multiple registers are active. Register priority is shown in the following chart.

Priority	Register
Highest	D-register, current waveform
:	C-register, current waveform
:	B-register, current waveform
:	A-register, current waveform
:	D-register, saved waveform
:	C-register, saved waveform
:	B-register, saved waveform
Lowest	A-register, saved waveform

To see how register priority works, view some spectra. Turn off A, turn on B, and note the on-screen readouts. The indicated resolution bandwidth should read 30 kHz. Turn on C, and the resolution bandwidth should read 5 MHz (C has a higher priority than B, so its readouts are displayed). Turn on the A register and set the resolution bandwidth to **AUTO**. Notice the **RBW** readout change. Any register containing a current sweep has a higher priority than a register containing a saved sweep, so the A-register readouts are now displayed.

When you are through experimenting, clear and deactivate the B and C registers. Leave only the D register active.

To acquire a frequency response reference, perform the following steps.

1. Press **[CATV/APPL] [5]** to call up the FREQ RESP SETUP menu.
2. Press **[1]** to select the "WITH REF" test mode.
3. Enter the start and stop frequencies as follows. Note that the default start frequency is the visual carrier for the lowest unskipped channel in the selected channel table, and the default stop frequency is the visual carrier for the highest unskipped channel in the selected channel table.  
  
(If the default start/stop frequency range is adequate for your measurements, press **[4]** to select it and go directly to step 6.)
4. Press **[2]** and enter a start frequency with the keypad.
5. Press **[3]** and enter a stop frequency with the keypad.
6. Press **[5]** to acquire a reference.

When the reference acquisition is complete, the instrument reverts to the spectral display and displays the message REFERENCE ACQUIRED.

If you wish to rename the new reference, press **[CATV/APPL] [5] [7] [W]** and follow the on-screen instructions. After renaming the new reference, press **[6] [n] [X]** (where n is a number from 0 to 9 representing a storage register) to save it. Press **[CATV/APPL] [0]** to run the frequency response measurement.

If you wish to save the new reference without renaming it, press **[CATV/APPL] [5] [6] [n] [X]** (where n is a number from 0 to 9). Press **[CATV/APPL] [0]** to run the frequency response measurement.

The measurement runs continuously while the instrument shows a display similar to that shown in Figure 6-5.

The top trace in Figure 6-5 is the raw trace. That portion of the reference where it breaks up might be a group of scrambled channels. In this case, it is the FM band. The reference was taken with the start frequency set at 55.25 MHz and the stop frequency set at 211.25 MHz (CH 2 to CH 13). The trace at center-screen is the frequency response.

**D Register** — The SAVE ENABLE key changes the function of the D key. **[SAVE ENABLE] [D]** places the 2714 in the waterfall mode (symbolized by the  icon below the D key). This waterfall display is more effective in peak acquisition mode (discussed under DSPL in Section 7).

100.0MHz	(AUTO SWEEP)	ATTN 40DB
58.8DBMV		VF 300KHz
5.0MHz/		10 DB/
300KHz RBW (AUTO)		CALIBRATOR

Press **[DSPL] [4]** to enter the peak acquisition mode. Press **[SAVE ENABLE] [D]** to enter the waterfall mode.

All eight of the register status LEDs light and four traces appear. Registers A, B, and C must be cleared before the 2714 allows you to enter the waterfall mode, because the waterfall mode uses all four registers. This is a safeguard to prevent accidental overwriting of previously saved data. If you attempt to enter this mode without first clearing the registers, you receive an error message.

Look at Figure 5-1. D is the bottom waveform and A the top. Each waveform is displaced upwards one division from the preceding waveform and shifted 1/2 division to the right. The current sweep is in the D register, the previous sweep in C, the next previous in B, and so on. At the end of each sweep, the waveforms are all shifted up one register. This display can be used to watch slowly varying spectra evolve or to obtain a feel for the variability of signals. Waterfall can also be useful for catching an event that occurs quickly. In the present case of the calibration signal, you will observe that there is virtually no variation.

Create a small signal shift by slightly changing the center frequency. Notice how the waterfall mode records the shift.

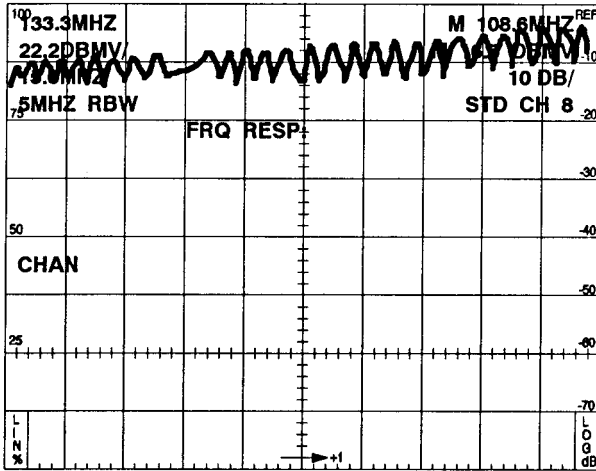

Figure 6-4: Typical Frequency Response Display Without Reference

You can then modify the display by various means (for example, changing the reference level, changing vertical sensitivity, using MARKER START/STOP to zoom in on any portion of the display).

A line drawn through the peaks of the waveform shown in Figure 6-4 represents the frequency response. The slope of this line suggests that the higher frequency channels have been provided with a little more gain compensation than the lower frequency channels to compensate for frequency-dependent losses in the transmission line. This display is useful only when frequency-dependent losses in the transmission line are known.

The instrument returns to the spectral display. Note that the FREQUENCY RESPONSE menu is still active. If you press [CATV/APPL] the FREQUENCY RESPONSE menu will be displayed.

A more definitive display is acquired by comparing the measurement to a known reference. Item 5 in the FREQUENCY RESPONSE menu lets you acquire this reference.

The reference may be taken at the head end and stored for use at any point along the transmission line, taken at any point in the transmission line and stored for use anywhere along the line, or taken at one point and stored for use for periodic checks over time at that same point.

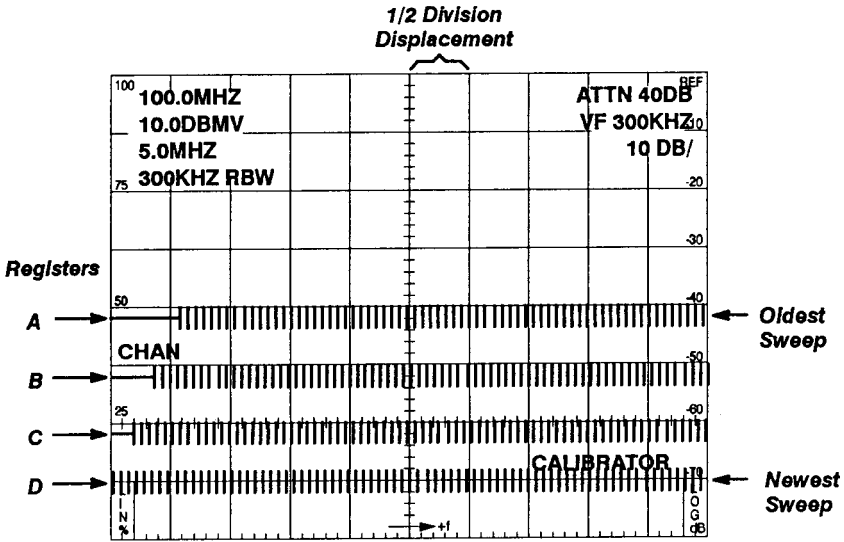

Figure 5-1: Example of a Waterfall Display

You can halt the waterfall action at any time by pressing **[SINGLE]** in the **SWEEP** function block. Thereafter, each time you press **[SINGLE]** the waterfall will advance one trace. Exit normally from the single sweep mode to continue the waterfall display.

You do not have to view all the traces. Turn off the A and C registers. Turn off B and D, and turn A and C back on. You can view any, all, or none of the registers. Turn them all off and the analog display reappears. However, the 2714 is still in waterfall mode. You cannot selectively erase a register or store new data in it without first exiting from the waterfall mode.

Turn on all registers. Exit from the waterfall display mode the same way you entered it; press **[SAVE ENABLE] [D]**.

All LEDs except the red D go out, and the waterfall display collapses to a single D register trace.

Reset the center frequency to 100 MHz. Return to the MAX/MIN acquisition mode by pressing **[DSPL] [4]**.

## Enable FREQUENCY RESPONSE Measurement

Press [7] to select the FREQUENCY RESPONSE measurement menu. This gives you the following three options and displays the current frequency response reference if one exists.

### 0 RUN FREQUENCY RESPONSE CURRENT REFERENCE:

Site Name, Date, Start Frequency, Stop Frequency; user-defined name; or <NONE>. The reference name appears only if the test mode WITH REF is selected. The string <SITE NAME>, <DATE>, <START>, <STOP> is the default reference name assigned when the reference is acquired. You can modify the reference name by selecting item 7 (EDIT CURRENT REFERENCE NAME) in the FREQ RESP SETUP menu.

- 5 FREQ RESP SETUP  
TEST MODES
- 0 NO REF
- 1 \*WITH REF
- 2 START FREQUENCY
- 3 STOP FREQUENCY
- 4 USE DEFAULT START/STOP<sup>2</sup>
- 5 ACQUIRE NEW REFERENCE
- 6 STORED REFERENCE MENU
- 7 EDIT CURRENT REFERENCE NAME
- 9 LEAVE FREQUENCY RESPONSE

Press [5] [0] [BKSP] [0] to run the frequency response measurement without a reference. The instrument sets the 2714 to sweep between the specified start and stop frequencies with a 5 MHz resolution bandwidth and returns to normal user control. The instrument shows a display similar to that shown in Figure 6-4.

**2** Lowest and highest frequencies in the selected channel table.



## MAX HOLD A & B

The A and B registers can be used in the MAX HOLD mode to save the peak values of measured spectra. The register must be cleared before you can use it in the MAX HOLD mode.

The MAX HOLD feature compares the amplitude of the current sweep, point for point, with the stored maximum value of previous sweeps. If the current amplitude is greater, the current value becomes the new stored maximum; if not, the previous value is retained.

Deactivate the D register. Make sure the A register is cleared and activated, then press **[MAX HOLD A & B]**.

The red LED below the **MAX HOLD A & B** key lights signifying that you have entered the MAX HOLD mode. The spectral display, especially the noise, is much smoother. After several minutes, the noise floor appears to drift upwards a couple of dB. Because the calibration signal is constant, there is no noticeable change in it. The upward drift of the noise floor slows and stops as the most likely maximum values are observed and stored. Now only an occasional noise peak exceeds the previously stored values. Activate the D register. Note that the waveform in the D register (waveform without MAX HOLD) is always less than the A register waveform. Recording the peak signal excursions observed during a large number of sweeps using the MAX HOLD feature yields an estimate of the maximum signal values. It can also be very useful for determining maximum signal amplitude during transient conditions or for making low-level fluctuating signals more apparent by saving their peak value. You can observe as many sweeps as you wish. You could equally as well have used the B register for MAX HOLD.

When you are ready to exit the MAX HOLD mode, press **[MAX HOLD A & B]** to turn off the A register. The red LED goes out, and only the D register sweep remains.

A feature called MIN HOLD, similar to MAX HOLD and activated by pressing **[DSPL] [9]**, saves the minimum signal values. Using both MIN HOLD and MAX HOLD, you can measure a signal's total excursion.

## CATV Measurements

resultant sweep, and retain the resultant waveform and instrument setup. The digital filter is used to smooth the reference to reduce sensitivity to slight frequency errors and differences in program material between the reference sweep and the subsequent frequency response peaks.

During reference acquisition, the reference name is assigned by linking the site name, current date, the start frequency, and the stop frequency. The name may be changed with the EDIT CURRENT REFERENCE NAME selection. This selection can only be used if there is a currently valid reference.

The reference is acquired with the 5 MHz RBW filter. The goal is to capture the video carrier peaks throughout the frequency range.

### Running The Mode 1 Test

If a valid reference exists, the mode 1 test (WITH REF) may be run. The first step is to recall the reference settings into the 2714 hardware. Then after each sweep, the raw sweep data is filtered using the identical digital filter used to filter the reference data. The reference waveform is then subtracted from the current waveform and the difference written into the C register for display on the screen.

This process continues until the user terminates the test by pressing **[W]** or **[Z]**. At termination, the last difference waveform is left saved in the C display.

### Running The Mode 2 Test

If mode 2 (NO REF) is selected, the instrument is set up to sweep between the specified freq limits. The 5 MHz RBW is selected, and the peak acquisition mode is installed. The start and stop frequencies of the sweep are taken from the start and stop frequencies currently defined for the reference. These default to the lowest and highest frequencies found in the channel table, but can be changed by the user in the FREQ RESP SETUP menu. The instrument then simply displays the raw sweep as it sweeps between those limits.

Press **[CATV/APPL]** to call up the CATV MEASUREMENTS menu. See Figure 6-1.

## FREQ/MKRS

The Freq Mkrs controls select single and delta markers, select center measure tracking, and control the marker peak find features.

### MKR/ $\Delta$ /OFF

The **MKR/ $\Delta$ /OFF** (Marker-Delta-Off) key is a three-way toggle that enables you to control one, or a pair, of markers. A marker is a bright spot that appears on the digitized waveform. Markers can be used only with the digital display. When the marker mode is turned off, the spot on the display indicates either the center or starting frequency of the display. When a single marker is turned on, it can be moved to any point along the displayed waveform using the **FREQ/MKRS** knob. The corresponding signal amplitude and frequency are displayed on screen. The marker amplitude readout represents the most accurate method for determining signal amplitude with the 2714 (unless a separate, extremely precise signal is used for direct comparison). In general, amplitude accuracy is further enhanced if the signal being measured is first moved to within one division of the top graticule line using the **REF LEVEL** controls.

In delta ( $\Delta$ ) marker mode, two markers designate the points on the waveform between which the differences in signal amplitudes and frequencies are measured and displayed. It is not possible to display one marker on a particular trace while displaying the second marker on another trace. More than one register can be displayed, but the markers appear only on the highest priority waveform.

To activate the marker, press [**MKR/ $\Delta$ /OFF**].

The sweep does not change, but the RF attenuation and video filter readouts have been replaced by approximate marker frequency and amplitude readouts such as the following.

**M 100.0MHZ**  
**M 18.8DBMV**

The M preceding the readouts represent the amplitude and frequency of the signal at the marker position. Turn the **FREQ/MKRS** knob several clicks clockwise. The marker moves to the right and the readout tracks it. The knob now controls the marker position rather than the center frequency. Move the marker into the noise. Notice that the marker actually moves up and down between the max and min noise values on alternate clicks of the knob. This is because each click

**NOTE**

*You can print measurement results only when the RS-232 interface is installed in the 2714. The GPIB interface does not support the print function.*

*Be sure to select handshaking ([UTIL] [4] [0] [2] [5]) to match that expected by the printer or long jobs may not print completely.*

Press **[4]** to print all stored results of the measurement. Again a printer must be connected to the 2714.

Press **[9]** to leave the HUM/LFD measurement and return to the CATV MEASUREMENTS menu.

---

**FREQUENCY RESPONSE Measurement**

The FREQUENCY RESPONSE test displays the difference between spectra taken at different times or places in the system (Mode 1) or a raw spectrum of the entire channel table (Mode 2). The modes are selectable from the **FREQ RESP SETUP** menu.

A Mode 1 frequency response test has two parts. The first part is acquisition of the reference and the second is comparing the current spectrum with the stored reference spectrum. The reference may be acquired either by measurement or by recalling a previously stored reference from NVRAM.

A Mode 2 frequency response test sets the instrument up into a mode that sweeps between specified frequency limits in a 5 MHz resolution bandwidth.

When the FREQUENCY RESPONSE measurement is initiated, the start and stop frequency limits default to the minimum and maximum frequencies in the selected channel table.

If a Mode 1 test has been selected, a reference must be acquired. A reference is acquired by using the ACQUIRE A REFERENCE selection in the FREQ RESP SETUP menu. The default start and stop frequency limits may be changed prior to acquiring the reference, if desired. (Whenever the start or stop frequencies are changed, the current reference is marked as invalid.) The instrument will sweep between the start and stop limits specified in this menu, apply a digital filter to the

of the knob moves the marker to the next bin in the digital waveform memory, thus tracking the stored max and min values. Turn the knob counterclockwise and the marker moves left. Again, the readout tracks the signal amplitude and frequency at the marker position. Be aware that the marker frequency accuracy is not as good as the center frequency accuracy because it includes a span nonlinearity component (see CTR-MEAS/TRKG later in this section for a discussion of frequency measurement accuracies).

If you attempt to move the marker past either edge of the display, the spectrum will move towards the opposite edge while the marker remains stationary. If you move the marker past the right edge, the signal peak moves to the left. Now turn the knob a few clicks counterclockwise. The marker moves to the left but the spectrum will not move back towards its original position until you attempt to move the marker past the other edge of the display. Re-center the calibration signal peak by trying to move the marker past the left edge of the display.

Ensure the marker and the calibration signal peak are centered and press [MKR/ $\Delta$ /OFF] again.

The spectral display did not change, but the marker frequency and amplitude readouts now read something like the following.

**D 0KHZ**  
**D 0.0DB**

The delta-marker mode is turned on. Turn the tuning knob clockwise. Now you can see both markers. One remains at the original marker position while the position of the second is controlled by the knob. The right column indicates the difference (denoted by the letter D preceding the readouts) in frequency and amplitude between the two marker positions.

Increase the span to 50 MHz/div. Use the tuning knob to place the movable marker at the top of the first signal peak to the right of center (the calibration signal second harmonic). The right column now reads approximately like the following.

**D 100MHz**  
**D -13.0 DB**

You are measuring the difference in frequency and amplitude between the fundamental and second harmonic of the calibration signal. Your instrument may not read these values exactly, but it should be close.

## CATV Measurements

The time domain data is displayed in waveform B.

Press **[CATV/APPL]** to call up the CATV MEASUREMENTS menu.  
See Figure 6-1.

### Enable HUM/LFD Measurement

Press **[6]** to select the HUM/LFD measurement menu. This gives you the following options.

- 0 RUN HUM/LFD
- 1 STORE CURRENT RESULTS
- 2 DISPLAY RESULTS
- 3 PRINT CURRENT RESULTS (*RS-232 Only*)
- 4 PRINT STORED RESULTS (*RS-232 Only*)
- 5 POWER LINE FREQ
- 9 LEAVE HUM/LFD

Press **[5]** to select the desired power line frequency (60 Hz or 50 Hz). The **[5]** key toggles between the two line frequencies.

Press **[0]** to run the Hum/LFD measurement. After the measurement is complete, the instrument displays the measured hum at the selected power line frequency and the time domain waveform in waveform B.

Press **[CATV/APPL]** to display the HUM/LFD menu.

Press **[1]** to store the results of the last measurement. After a short period of time, the message RESULTS STORAGE COMPLETE is displayed.

Press **[2]** to display the results of the last measurement performed. A display resembling Figure 6-2 comes up showing the current result. You can either go ahead and view other previously stored results for this measurement by pressing **[W]**, or stop viewing the results by pressing **[Z]**.

Press **[3]** to print the results of the last measurement performed. A printer must be connected to the 2714.

## Enhanced Versatility

If you attempt to steer the movable marker past the edge of the display, you will see that the spectral display behaves almost the same as it did for the single marker. The difference is that the stationary marker remains fixed with respect to the spectrum. You can even force the stationary marker off screen and the readout will continue to indicate the difference between the two marker positions. In this way you can make difference measurements across the whole input range of the 2714.

Turn the tuning knob clockwise until the readout indicates the movable marker is 900 MHz to the right of the stationary marker. If the sixth or seventh harmonics of the calibration signal near center screen are not visible, turn on the video filter. The peaks should now be visible. Place the moveable marker on either peak to measure its difference in amplitude and frequency relative to the fundamental.

Exit the marker mode by pressing **[MKR/Δ/OFF]** until the normal RF attenuation and video filter readouts return (one press if in Δ-marker mode, two if in single-marker mode).

Turn off the video filter.

### CTR-MEAS/TRKG

140.0MHz	(AUTO SWEEP)	ATTN 10DB
28.8DBMV		VF WIDE
50.0MHz/		10 DB/
5MHz RBW (AUTO)		CALIBRATOR

The center measure feature detects the signal peak nearest the marker and above a preset amplitude threshold (changing the threshold is discussed in Section 7 under the **MKR/FREQ** menu). When the marker is turned off, the signal peak nearest center screen is used. The 2714 then measures the signal frequency and makes it the new center frequency.

This feature allows you to bypass tuning to measure a signal frequency; just place the marker close to the signal of interest and press **[CTR-MEAS/TRKG]**. Press the key twice to enable the signal track feature to keep drifting signals centered by continuously repeating the center measure feature.

When the HUM/LFD measurement is initiated, the firmware configures the 2714 as follows.

- Clear all waveform display registers (unsaved displays)
- Sweep triggering: Free Run, single sweep
- Center Frequency: Visual carrier of the currently selected channel.
- Span/div: 600 kHz/div
- Resolution bandwidth: 300 kHz
- Video filter: Off
- Acquisition mode: Peak
- Reference level: signal peak is at top of screen.
- Vertical mode: Linear
- Span: Zero Span
- Sweep speed: 20 ms/div

A time domain (ZERO SPAN) waveform is acquired. This waveform is converted to the frequency domain using a Fast Fourier Transform (FFT) calculation so that the percent hum for the power line fundamental and 1<sup>st</sup> harmonic can be measured. The hum values are calculated from the FFT result as follows.

$$4 \times 100 \times \frac{\text{Power Line Frequency Component}}{\text{Visual Carrier Component}}$$

The factor of four (4) comes from the following two sources.

- The two-sided nature of the FFT requires that the apparent levels of each harmonic be doubled
- The result must be doubled again to obtain the peak-to-peak harmonic levels since the FFT finds only the peak value of each harmonic component

The hum data values are shown in the two readout lines as follows.

ZZ.Z% TOTAL HUM  
XX.X% @ F<sup>0</sup> YY.Y% @ F<sup>1</sup>

where F<sub>0</sub> is the power line fundamental (50 Hz or 60 Hz)  
and F<sub>1</sub> is the power line 1<sup>st</sup> harmonic (100 Hz or 120 Hz).



**NOTE**

**CTR-MEAS/TRKG** provides the easiest and most accurate method of determining a signal's frequency.

To use the center measure feature, turn on the marker and use the **FREQ/MKRS** knob to place the marker near the calibration signal. (In general, place the marker near the signal of interest. If you do not turn on the marker, the signal nearest center screen is measured.) Set the reference level so the signal peak is within one division of the top graticule line and press **[CTR MEAS/TRKG]**.

The calibration signal is recentered, and the amplitude and frequency of the centered signal are read out at the upper right of the screen preceded by a C (counter). The counter readout provides the most accurate frequency determination available on the 2714, and its resolution can be set to 1 Hz if desired. The counter readings disappear when a control setting is altered.

The marker and counter amplitude readouts are equally accurate. However, the signal amplitude indicated by the position of the marker relative to the graticule may differ slightly from the readout. The readout is more accurate because it contains no display nonlinearities.

The center frequency and counter measurements are also equally accurate, but in general the counter readout is more precise.

To look closely at the calibration signal third harmonic, place the marker near the third harmonic (approximately 280 MHz) and press **[CTR MEAS/TRKG]**.

The calibration signal third harmonic is now the new center frequency and its frequency and amplitude are displayed at the top of the right-hand readouts.

Now enter the delta-marker mode. Place the movable marker near the calibration signal fundamental (at 100 MHz) and press **[CTR MEAS/TRKG]**.

This mode of operation centers the signal peak nearest the movable marker and measures the difference between the centered signal and the signal at the fixed marker. In this case, the fundamental is re-centered, and the markers appear on top of it and the third harmonic. Readings of approximately 200 MHz and 12 dB appear at the top of the left column preceded by the letters DC (delta-counter). The center

Press **[0]** to run the Carrier To Noise measurement. After the measurement is complete, the instrument displays the current results, the offset frequency (from the carrier) at which the noise was measured, and the normalization bandwidth superimposed on the spectral display.

Press **[CATV/APPL]** to display the CARRIER TO NOISE menu.

Press **[1]** to store the results of the last measurement. After a short period of time, the message RESULTS STORAGE COMPLETE is displayed.

Press **[2]** to display results of the last measurement performed. A display resembling Figure 6-2 comes up showing current results and the normalization bandwidth. You can either go ahead and view other previously stored results for this measurement by pressing **[W]**, or stop viewing the results by pressing **[Z]**.

Press **[3]** to print the results of the last measurement performed. A printer must be connected to the 2714.

### NOTE

*You can print measurement results only when the RS-232 interface is installed in the 2714. The GPIB interface does not support the print function.*

*Be sure to select handshaking (**[UTIL] [4] [0] [2] [5]**) to match that expected by the printer or long jobs may not print completely.*

Press **[4]** to print all stored results of the measurement. A printer must be connected to the 2714.

Press **[9]** to leave the CARRIER TO NOISE measurement and return to the CATV MEASUREMENTS menu.

---

## HUM/LFD Measurement

The HUM/LFD measurement records and displays the peak-to-peak HUM/LFD parameters for the currently selected channel.

HUM is measured on an unmodulated carrier and includes the power line fundamental and 1<sup>st</sup> harmonic. LFD is measured on a modulated carrier and may include some video-related energy.

## Enhanced Versatility

measure feature with the delta marker mode provides a convenient method of determining precise signal differences without manual tuning or interpolation of graphical data.

Turn off the markers.

The center measure feature can perform still another function. When center measure is used in the zero span mode, the counter measures the frequency at the output of the 2714 detector. Because the output varies only if the signal is modulated, the counter is actually measuring the frequency of the modulation (if none is present, you receive a message saying so). Normally, AM detection is used, but you can select FM detection. Whichever detector is selected, the center measure feature provides a quick method of determining the frequency of the modulating signal. Of course, the modulation frequency must fall within the bandwidth of the resolution bandwidth filter and any video filter that is active (and the FM discriminator when FM detection is selected). Reset the 2714 controls according to the following settings box.

<b>100.0MHz</b>	<b>(AUTO SWEEP)</b>	<b>ATTN 10DB</b>
<b>28.8DBMV</b>		<b>VF WIDE</b>
<b>20.0MHz/</b>		<b>10 DB/</b>
<b>5MHz RBW (AUTO)</b>		<b>CALIBRATOR</b>

The signal track feature of the 2714 continuously repeats the center measure operation. On each sweep the signal nearest midscreen is remeasured and recentered. This is useful for keeping a slowly varying or jittering signal centered for close observation.

To activate signal track, press **[CTR MEAS/TRKG]** twice.

The term TRKG appears in center screen indicating that the 2714 is in the signal track mode.

If you turn the tuning knob while a sweep is underway, the signal will be displaced a bit during the next sweep. On the following sweep the signal is recentered. The frequency readouts change because the tracking mode continuously repeats the center measure feature.

If the signal being tracked falls below a preset threshold (see Setting the Signal Threshold in Section 7), tracking halts and the message **NO SIGNAL FOUND ABOVE THRESHOLD** is displayed.

4. Measures the noise at the marker using the built-in noise measurement routine, which applies all the noise measurement corrections for filter bandwidth, log and detector corrections, and proximity to the 2714 noise floor. Saves this value as the noise level.
5. Subtracts the noise level from the carrier level and displays the result.

Press **[CATV/APPL]** to call up the CATV MEASUREMENTS menu.  
See Figure 6-1.

### Enable CARRIER TO NOISE Measurement

Press **[5]** to select the CARRIER TO NOISE measurement menu. This gives you the following options.

- 0 RUN CARRIER TO NOISE
- 1 STORE CURRENT RESULTS
- 2 DISPLAY RESULTS
- 3 PRINT CURRENT RESULTS (*RS-232 Only*)
- 4 PRINT STORED RESULTS (*RS-232 Only*)
- 5 CARRIER/NOISE SETUP
- 9 LEAVE CARRIER TO NOISE

Press **[5]** to call up the CARRIER/NOISE setup menu (test modes). This gives you the following options.

- 0 INTERACTIVE
- 1 AUTO
- 2 AUTO with (PAUSE FOR CARRIER OFF)
- 5 NOISE NORM'D BW

In Interactive Test Mode, you will be prompted to place the marker on the noise floor at some time during the measurement.

In Auto Test Mode, you will not be required to do any settings.

In Auto with Pause-for-Carrier-Off Test Mode, you will be prompted to turn off the carrier at some time during the measurement.

In addition to the three test modes, you are given the option of resetting the normalized noise bandwidth. The default bandwidth is 4 MHz.

Press **[BKSP]** to return to the CARRIER TO NOISE measurement menu.

The message is accompanied by a beep. When the signal rises back above threshold, signal track automatically resumes.

Simulate signal loss and recovery by turning the calibrator off and then back on again. The audible beep makes this signal track mode useful as an amplitude threshold detector.

You can also obtain continuous counter readings in the signal track mode. Press **[MKR/FREQ] [9] [1] [2]** to turn on the counter (see Counter Resolution in Section 7 for additional information).

To continuously monitor a frequency difference, press **[CTR MEAS/TRKG]** again to exit from tracking mode. Reset the span to 50 MHz/division and enter the delta-marker mode. Place the movable marker near the third harmonic. Re-enter the tracking mode. You are using the delta-counter feature in the signal track mode. The third harmonic is centered and the frequency difference between the fundamental and third harmonic is being constantly monitored.

Exit from the tracking mode and turn off the markers.

## Arrow Keys

Center the calibration signal, and turn on the marker. Press **[MKR] [↕]**. The marker jumps to the second harmonic peak. Press the key again and it jumps to the third harmonic.

Now press **[MKR] [↕]**. The marker jumps in the other direction. **[MKR] [↔]** and **[MKR] [↕]** move the marker to the next signal peak in the indicated direction and above the preset threshold, but they will not go beyond the edge of the display or lower than 0 Hz. Further, the readouts and center measure/tracking behave as if you had manually moved the marker.

Enter the delta-marker mode and press the arrow keys. The movable marker jumps in the direction of the arrows just as the single marker did, and the readouts behave as if you had manually moved the marker.

## PEAK FIND

Ensure that the markers are turned off. Set the center frequency to 275 MHz and press **[PEAK FIND]**. The marker is automatically turned on and jumped to the peak of the calibration signal at 100 MHz. The

**NOTE**

*You can print measurement results only when the RS-232 interface is installed in the 2714. The GPIB interface does not support the print function.*

*Be sure to select handshaking ([UTIL] [4] [0] [2] [5]) to match that expected by the printer or long jobs may not print completely.*

Press [4] to print all stored results of the measurement. A printer must be connected to the 2714.

Press [9] to leave the AURAL (FM) DEVIATION measurement and return to the CATV MEASUREMENTS menu.

---

## CARRIER TO NOISE Measurement

The CARRIER TO NOISE measurement records and displays the visual carrier-to-noise ratio for the current channel.

When the CARRIER TO NOISE measurement is initiated, the 2714 performs the following.

1. Tunes to the carrier frequency and sets RBW to 300 kHz with no video filter, span to 200 kHz/div, sweep speed of .5 s/div, and makes a single sweep. It then does a peak search with the marker and records the maximum value as the carrier level.
2. Returns to a point that places the low end of the channel at the first division. Selects 30 kHz RBW and turns on the video filter. Places the marker on the minimum point of the waveform and, if necessary, sets the reference level to set that point at least 1 division above the bottom of the screen. Sets the RF attenuation to 0, so that the built-in noise measurement routine can accurately apply the noise proximity correction.
3. If in the interactive mode, prompts the user to adjust the noise marker. If in auto with pause-for-carrier-off, prompts the user to turn off the carrier.

2714 detected the highest signal on screen and automatically moved the marker to it. After the move, the 2714 behaves exactly as if you had moved the marker there manually.

Press **[MKR]** [**↓**] to move the marker to the peak of the third harmonic. Press **[PEAK FIND]** again. The marker moves back to the fundamental; the marker peak find feature always locates the highest peak on screen.

---

## Miscellaneous Controls

*Any control settings can be used*

We have discussed and experimented with all the 2714 functions except the menu keys and a few miscellaneous controls. The menu keys are covered thoroughly in Section 4, and the remaining, miscellaneous controls will be covered briefly here.

### PLOT

Immediately below the **VERT SCALE** function block is a **PLOT** button that causes an optional printer or plotter to draw an image of the screen. The on-screen readouts are plotted on the drawing in the border area so they do not interfere with the waveform. If you wish to have graticule lines on the printout, you must turn them on by pressing **[UTIL]** [**4**] [**1**] [**5**]. You can also add labels to the plot (see Adding Titles and Labels in Section 7).

Before attempting to create a screen plot, ensure that the communications port is correctly configured (see System Configuration in Section 7).

To make a plot of the screen, check that your printer or plotter is powered up, on line, and that the paper is in correct registry. Then, with the 2714 displaying the desired trace(s), press **[PLOT]**.

The printer or plotter quickly begins to draw the trace. Because the printer or plotter output data is sent to a temporary buffer, the 2714 returns to the spectral display and is ready to accept additional commands before printing or plotting ends. A typical plot is shown in Figure 5-2.

## Enable AURAL (FM) DEVIATION Measurement

Press **[CATV/APPL]** to call up the CATV MEASUREMENTS menu.  
See Figure 6-1.

Press **[4]** to select the AURAL (FM) DEVIATION measurement menu.  
This gives you the following options.

- 0 RUN AURAL (FM) DEVIATION**
- 1 STORE CURRENT RESULTS**
- 2 DISPLAY RESULTS**
- 3 PRINT CURRENT RESULTS (RS-232 Only)**
- 4 PRINT STORED RESULTS (RS-232 Only)**
- 9 LEAVE (FM) DEVIATION**

Press **[0]** to run the Aural (FM) Deviation measurement. After the measurement is complete, the instrument displays the message

RESUME OR ACCEPT CURRENT MEAS  
"W" TO RESUME, "Z" TO ACCEPT

and the current results. Press **[W]** to run the measurement again or **[Z]** to accept the current measurement. If you press **[W]** to run the measurement again, waveform C continues to accumulate peak deviation data over the next 20 sweeps (it does not start over).

Press **[CATV/APPL]** to display the AURAL <FM> DEVIATION menu.

Press **[1]** to store the results of the last measurement. After a short period of time, the message RESULTS STORAGE COMPLETE is displayed.

Press **[2]** to display results of the last measurement performed. A display resembling Figure 6-2 comes up showing FM deviation. At this point you can choose to either go ahead and view other previously stored results for this measurement by pressing **[W]**, or stop viewing the results by pressing **[Z]**.

Press **[3]** to print the results of the last measurement performed. A printer must be connected to the 2714.



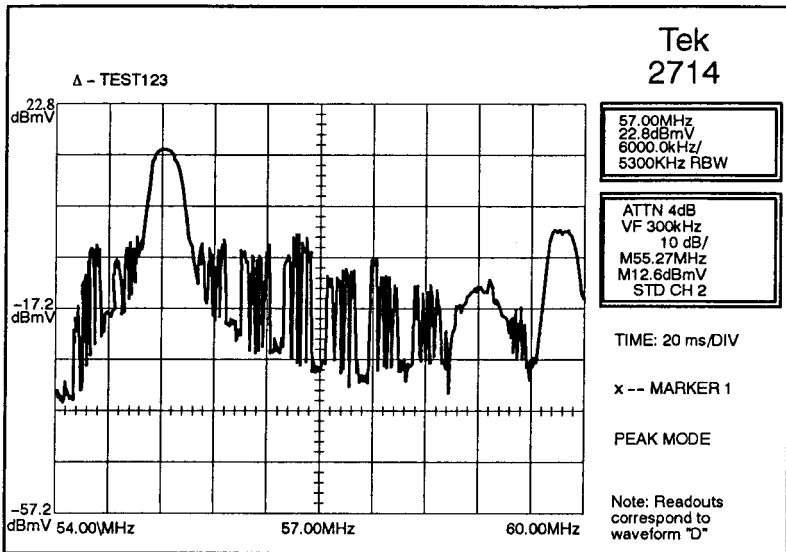



Figure 5-2: Typical Plotter Output Showing TV Channel Spectrum

### NOTE

*Plotting time can be reduced by choosing peak acquisition mode, or using the video filter, to reduce noise variations. Noise variations do not affect printing time when using a dot-matrix printer.*

### READOUT

You can toggle the standard on-screen readouts on and off. There are two reasons for doing so. First, it prevents the readouts from overlapping the signal spectrum.

To understand the second reason, initialize the 2714 to the factory power-up defaults and enter the analog display mode. Press **[SWEEP]** [  ], and notice the regularly spaced dark areas in the sweep. Now turn off the readouts by pressing **[READOUT]** below the VERT SCALE function block.

Press **[9]** to leave the Modulation Depth measurement and return to the CATV MEASUREMENTS menu.

---

### AURAL (FM) DEVIATION Measurement

The AURAL CARRIER DEVIATION measurement records and displays the peak frequency deviation of the aural carrier on the current channel.

When the CARRIER SURVEY measurement is initiated, the 2714 performs the following.

1. The 2714 checks if the channel table specifies this channel as TV or FM. If the channel is specified other than TV or FM, the measurement is aborted.
2. The 2714 tunes to the aural carrier of the current channel as specified in the channel table and places a marker at the aural carrier location.
3. The 2714 sets the RBW and VF to 100 kHz.
4. The 2714 performs a center measure to count and recenter the aural carrier.
5. The 2714 enables ZERO SPAN, selects FM Deviation, sets sweep time to 100 ms/div, enables waveform C as the MIN HOLD destination, and turns on min hold.
6. The 2714 makes 20 sweeps while waveform C accumulates peak deviation over the 20 sweeps to ensure that maximum deviation is acquired in the presence of normal program material.
7. The 2714 computes the result as a "mean peak deviation" after rejecting widely deviating readings. It computes the mean and standard deviations of all the data in waveform C, discards the data more than two standard deviations from the mean, and computes a new mean from the remaining data.
8. Waveform B is then loaded with a straight line halfway across the screen (horizontally) to mark the position of the computed mean.

After a measurement, the user is prompted to either accept the current measurement or run another one. The min hold register is not cleared between measurements to allow further accumulation of the peak deviation.

The dark areas are gone now. The dark areas represent time when the CRT beam is writing the on-screen readouts. Their appearance changes with sweep speed. By eliminating the readouts, you eliminate the dark areas. You will also notice that the trace has intensified. This is because the 2714 does not have to take time out from each sweep to write the on-screen data.

Turn the data readouts back on again, by pressing **[READOUT]**, activating register D, and pressing **[AUTO]** in the SWEEP function block.

## INTENSITY

The intensity control is a rotary knob that works exactly like any oscilloscope intensity control. Twist the **INTENSITY** knob slowly back and forth. Notice the display grow brighter and dimmer as you turn the control. Leave the intensity set to a level sufficient for good contrast in your ambient light conditions. If you have to turn it to full intensity, try reducing the ambient light or shielding the display. If the 2714 is used in direct sunlight, a contrast-enhancing light filter is recommended (part of the Travel Line Package, Option 33).

## Rear Panel Trace Adjustments

There are three controls (**TRACE ROTation**, **VERTical POSition**, and **HORIZontal POSition**) at the upper right of the 2714 rear panel that are used with a built-in test display to adjust trace alignment. The control shafts are recessed within hexagonal nuts that attach the controls to the 2714 chassis. Do not attempt to turn the hexagonal nuts and do not use excessive force when turning the control shafts. A plastic adjustment tool is recommended in preference to a screwdriver.

## Enable MODULATION DEPTH Measurement

Press **[CATV/APPL]** to call up the CATV MEASUREMENTS menu.  
See Figure 6-1.

Press **[3]** to select the MODULATION DEPTH measurement menu.  
This gives you the following options.

- 0 RUN MODULATION DEPTH**
- 1 STORE CURRENT RESULTS**
- 2 DISPLAY RESULTS**
- 3 PRINT CURRENT RESULTS (RS-232 Only)**
- 4 PRINT STORED RESULTS (RS-232 Only)**
- 9 LEAVE MODULATION DEPTH**

Select item 0 to run the Modulation Depth measurement. After the measurement is complete, the instrument displays the current results superimposed on the spectral display.

Press **[CATV/APPL]** to display the MODULATION DEPTH menu.

Press **[1]** to store the results of the last measurement. After a short period of time, the message RESULTS STORAGE COMPLETE is displayed.

Press **[2]** to display results of the last measurement performed. A display resembling Figure 6-2 comes up showing percent modulation. At this point you can choose to either go ahead and view other previously stored results for this measurement by pressing **[W]**, or stop viewing the results by pressing **[Z]**.

Press **[3]** to print the results of the last measurement performed. A printer must be connected to the 2714.

### NOTE

*You can print measurement results only when the RS-232 interface is installed in the 2714. The GPIB interface does not support the print function.*

*Be sure to select handshaking (**[UTIL] [4] [0] [2] [5]**) to match that expected by the printer or long jobs may not print completely.*

Press **[4]** to print all stored results of the measurement. A printer must be connected to the 2714.



# **CATV Measurements**

Press [9] to leave the Carrier Survey measurement and return to the CATV MEASUREMENTS menu.

---

### MODULATION DEPTH Measurement

The MODULATION DEPTH measurement records and displays the depth of modulation for the current channel.

When the MODULATION DEPTH measurement is initiated, the 2714 performs the following.

1. The 2714 tunes to the carrier frequency, finds the peak value, and moves the signal to top of screen. The 2714 then enables zero span, linear vertical scale, and 1 MHz RBW filter.
2. If VITS is present in the selected channel table data for this channel, the 2714 uses the VITS line to determine depth of modulation. (The VITS line must include a 100% white signal for this method to work.) In this case, the sweep time is set to 100  $\mu$ s/div and the trigger mode to TV line trigger.

The VITS line is defined in the channel table using the PC software.

If VITS is not present, the sweep time is set to 2 ms/div and the trigger mode to FREE RUN.

In either case (VITS or no VITS), 10 sweeps are taken and modulation depth is computed for each sweep. The final result is the average of all 10 sweeps. For each sweep, modulation depth is computed as follows.

$$\frac{\text{max}}{\text{max} - \text{min}} \times 100\%$$

3. The 2714 turns on waveforms B and C. Waveform B is the max hold destination register and C is the min-hold destination register. The 2714 enables both max hold and min hold, and sweeps 10 times.

#### NOTE

*This measurement does not work well on a scrambled channel where the sync tip is not present.*



```

CARRIER LEVEL:                CURRENT
CHAN 8      01-MAY-92          12:00:00
STD

----- CHANNEL 2 -----
VISUAL 10.5 DBMV @ 55.250000MHZ
AURAL  -15.8DBC @ +4.500000MHZ
----- CHANNEL 3 -----
VISUAL  9.8 DBMV @ 61.250000MHZ
AURAL  -15.4DBC @ +4.500000MHZ
----- CHANNEL 4 -----
VISUAL  9.5 DBMV @ 67.250000MHZ
AURAL  -15.1DBC @ +4.500000MHZ

PRESS "W" TO CONT, "Z" TO ABORT

```

**Figure 6-3: Typical Carrier Survey Report Screen**

After all of the current results have been displayed (as you continue pressing **[W]** or if you press **[Z]**), the 2714 starts displaying stored results for the Carrier Survey measurement beginning with the last stored results.

After all the results have been displayed, the 2714 reverts to the CARRIER SURVEY menu.

Press **[3]** to print results of the last measurement performed. A printer must be connected to the 2714.

#### **NOTE**

*You can print measurement results only when the RS-232 interface is installed in the 2714. The GPIB interface does not support the print function.*

*Be sure to select handshaking (**[UTIL] [4] [0] [2] [5]**) to match that expected by the printer or long jobs may not print completely.*

Press **[4]** to print all stored results of the measurement. A printer must be connected to the 2714.





# CATV Measurements

<b>8.75 MHZ</b>	<b>(AUTO SWEEP)</b>	<b>ATTN 50DB</b>
<b>57.00DBMV</b>		<b>VF WIDE</b>
<b>600MHZ/ MAX</b>		<b>10 DB/</b>
<b>300KHZ RBW</b>		<b>STD CH 2</b>

Firmware-based CATV measurement routines allow technicians to easily make frequency domain and baseband measurements. Without these automated routines, making these measurements would require a high degree of technical expertise, require a long setup time, and be subject to error.

---

## CATV Preliminary Information

This section provides information on the necessary input power limitations for CATV operation, an overview of CATV preparatory information, and specific 2714 CATV applications.

CATV measurements/capabilities include the following.

- Carrier level and frequency measurement
- Survey of system visual and aural carrier levels and frequencies measurement
- Depth of modulation measurement
- Aural carrier deviation measurement
- Visual carrier-to-noise ratio measurement
- Hum/low frequency disturbance measurement
- System frequency response measurement
- Viewing demodulated video and baseband modulation
- Viewing picture
- Listen mode (aural carrier demodulation)

To reduce the run time, you may want to tag unwanted channels for omission (skipping) from the survey. To use the "Skip Channel" selection, you must select a channel and then go into the setup menu and skip the channel. The following sequence demonstrates the steps that must be followed to skip channels.

1. Press any menu button to acquire a spectral display.
2. Select a channel.
3. Press **[CATV/APPL] [8] [2]** to skip the selected channel.

The following sequence must be repeated for all unwanted channels.

1. Select a channel.
2. Press **[CATV/APPL] [2]** to skip the selected channel.

You may skip channels in two ways. One way is through the PC software that is provided as an accessory. It lets you skip all unwanted channels at one time. Refer to the 2714 Cable TV System Test Software manual. The other way is with the CATV/APPL menu, as previously described.

Another way to reduce run time would be to select FAST SURVEY in the CARRIER SURVEY menu to turn on FAST SURVEY (**[APPL/CATV] [2] [5]**).

Select item 0 from the CARRIER SURVEY menu to run the CARRIER SURVEY measurement. After the measurement is complete, the instrument displays the message RESULTS AVAILABLE VIA "DISPLAY" IN THE CARRIER SURVEY MENU.

Press **[CATV/APPL]** to display the CARRIER SURVEY menu.

Press **[1]** to store the results of the last measurement. After a short period of time, the message RESULTS STORAGE COMPLETE is displayed.

Press **[2]** to display the results of the last measurement performed. A display resembling Figure 6-3 comes up. You can choose to either go ahead and page through all the stored results for the last measurement by repeatedly pressing **[W]**, or stop viewing the results by pressing **[Z]**.

## CATV Measurements

- Composite triple beat/composite second order beat measurements
- Cross modulation measurement

Be sure that the input power limitation is not exceeded before connecting a cable feed to the RF INPUT. Read the INPUT POWER LIMITATIONS information.

### Input Power Limitations



*The safe maximum total RF input power for the 2714 is +70 dBmV. DC input voltage is limited to 100 VDC maximum.*

Total input power above the rated maximum can cause damage to the instrument and voids the factory warranty. For a number of equal amplitude signals, the total power is approximately:

$$\text{Total Signal} = \text{Single Signal} + 10 \log (\text{Number of Signals})$$

Thus, the safe maximum amplitude per signal is given in Table 6-1.

**Table 6-1: Safe Maximum Signal Levels**

Number of Signals Input to Spectrum Analyzer	Safe Maximum Amplitude per Signal (dBmV)
1	+70.0
10	+60.0
30	+55.2
50	+53.0
70	+51.5
100	+50.0

Remember, two 68 dBmV signals total more than 70 dBmV. Higher signal levels should be externally attenuated.

Press **[2]** to select the CARRIER SURVEY measurement menu. This gives you the following options.

- 0 RUN CARRIER SURVEY**
- 1 STORE CURRENT RESULTS**
- 2 DISPLAY RESULTS**
- 3 PRINT CURRENT RESULTS (RS-232 Only)**
- 4 PRINT STORED RESULTS (RS-232 Only)**
- 5 FAST SURVEY**
- 6 EXTERNAL ATTEN/AMPL**
  
- 9 LEAVE CARRIER SURVEY**

Before running the CARRIER SURVEY measurement, select either FAST SURVEY ON or FAST SURVEY OFF from the CARRIER SURVEY menu. FAST SURVEY ON measures the carrier amplitudes only, and FAST SURVEY OFF measures both carrier amplitudes and frequencies.

The FAST SURVEY option is toggled on and off by selecting 5 from the menu.

**FAST SURVEY ON** — When the CARRIER SURVEY measurement is initiated, the 2714 performs the following.

- Tunes to the center of the first unskipped channel in the table
- Uses the visual and aural carrier frequencies listed in the channel table for the current channel as references
- Measures the amplitude at the two carrier frequencies
- Calculates the video-to-aural carrier amplitude ratio from amplitude levels obtained
- Applies frequency response corrections to both carrier amplitudes
- Repeats parts 1 through 5 for all unskipped channels

**FAST SURVEY OFF** — Running this measurement will take a considerable amount of time because the 2714 runs a carrier levels measurement of all channels in the selected channel table.



*To avoid overloading the 2714 and possibly damaging it, do not place AC or DC power supply voltages on the input of the 2714.*

## Initial Setup

At power-up, the 2714 comes up in the CATV mode tuned to the default power-up channel. The power-up channel is the last active channel when power was turned off or channel T-7 (labeled 907 in STD Table 6-3) if NVRAM was erased before the last power-down. (The CATV MEASUREMENT MODE will remain active until it is explicitly disabled by pressing [CATV/APPL] [8] [0])

Upon entering the CATV MEASUREMENT MODE, the instrument software searches for the visual carrier signal associated with the default power-up channel and places a marker at the visual carrier peak. The instrument then configures itself as follows.

Frequency	Center of default power-up Channel Band <sup>1</sup>
Reference Level	+68.8 dBmV
Span/Div	Channel Band — 10
RF Attenuation	50 dB
Resolution Bandwidth	300 kHz
Sync & Video Polarity	From current channel table
Vertical Mode	Log
Vertical Scale	10 dB/div
Sweep	Auto
Trigger	Free Run
Marker	On
Marker Frequency	Apparent Visual Carrier Position

**1 Channel Band = Channel limits defined in the current channel table. If the last selected channel does not exist, such as when NVRAM has been erased, the default channel becomes Channel T-7 (labeled 907 on the display) – the first channel in the first channel table.**

## CATV Measurements

The word STORED appearing at the upper right corner of the display means that you are looking at a stored result for the particular measurement. Stored results are displayed in sequence starting with the most recently stored result.

Press **[3]** to print the results of the last measurement performed. A printer must be connected to the 2714.

### NOTE

*You can print measurement results only when the RS-232 interface is installed in the 2714. The GPIB interface does not support the print function.*

*Be sure to select handshaking ([UTIL] [4] [0] [2] [5]) to match that expected by the printer or long jobs may not print completely.*

Press **[4]** to print all stored results of the measurement. A printer must be connected to the 2714.

Press **[9]** to leave the Carrier Levels measurement and return to the CATV MEASUREMENTS menu.

---

## CARRIER SURVEY Measurement

Select CARRIER SURVEY from the CATV MEASUREMENTS menu.

The CARRIER SURVEY measurement provides a survey of all active (unskipped) channels in the current channel table, and makes a record of the following parameters.

- Visual carrier frequency
- Visual carrier amplitude
- Intercarrier frequency
- Visual-to-aural carrier amplitude ratio

### Enable CARRIER SURVEY Measurement

Press **[CATV/APPL]** to call up the CATV MEASUREMENTS menu. See Figure 6-1.

## General (CATV) 2714 Mode

If the 2714 is in the CATV mode, press **[CATV/APPL]** and the CATV mode comes up on the screen. If the 2714 is not already in the CATV mode, press **[CATV/APPL] [8] [0]** from the spectral display.

The firmware centers the channel on the screen, then displays the top level (PG 1) of the CATV MEASUREMENTS menu. The menu resides on two pages. You can toggle between the menu pages by pressing from either page. See Figure 6-1.

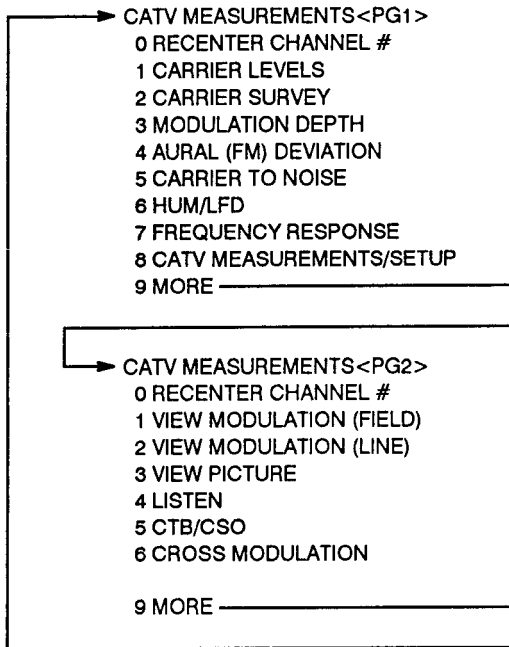

Figure 6-1: CATV MEASUREMENTS Menu

## 9 LEAVE CARRIER LEVELS

Select item 0 to run the Carrier Levels measurement. After the measurement is complete, the instrument displays the current results superimposed on the spectral display.

Press **[CATV/APPL]** to again display the CARRIER LEVELS menu.

Press **[1]** to store the results of the last measurement along with the channel table, channel number, time, date, site, and operator information. After a short period of time, the message RESULTS STORAGE COMPLETE is displayed.

Press **[2]** to display the results of the last measurement performed. A display resembling Figure 6-2. comes up. At this point you can choose to either go ahead and view other previously stored results by pressing **[W]**, or stop viewing the results by pressing **[Z]**.

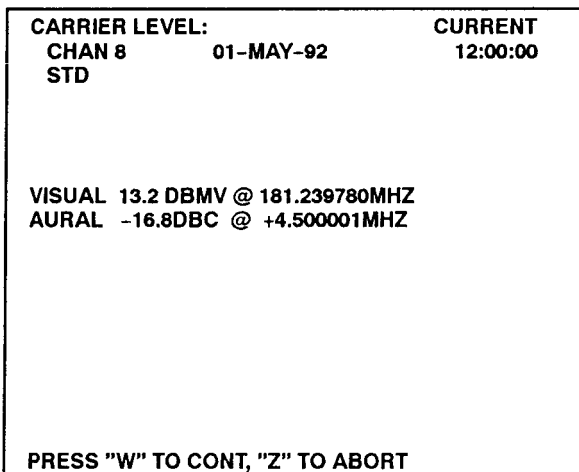

**Figure 6-2: Carrier Levels Measurement Results**

The word CURRENT appearing at the upper right corner of the display means that you are looking at the result of the most recent measurement performed.



## Signal Types

The 2714 is capable of making certain measurements on TV, FM, Pilot, and Data signals in the CATV mode.

Table 6-2 shows the measurements that can be made on each signal type.

**Table 6-2: Signal Type Measurements**

Measurements	Signal Types			
	TV	FM	Pilot	Data
Carrier Levels	X	X	X	X
Carrier Survey	X	X	X	X
Modulation Depth	X			
Aural (FM) Deviation	X	X		
Carrier To Noise	X	X	X	X
Hum/LFD	X	X	X	X
Frequency Response	X	X	X	X
View Field Modulation	X			
View Line Modulation	X			
View Picture	X			
Listen	X	X		
CTB/CSO	X	X	X	X
Cross Modulation	X	X	X	X

## Channel Tables

Channel tables are the central data that controls the actions of the measurements. The 2714 uses channel tables to tune to different channels in any one CATV system. Thus, the resident firmware provides three commonly used (factory-loaded) channel tables.

STD  
HRC  
IRC

## CARRIER LEVELS Measurement

The CARRIER LEVELS measurement records and displays the peak visual carrier level, visual carrier frequency, intercarrier frequency, and visual-to-aural carrier amplitude ratio for the current channel.

When the CARRIER LEVELS measurement is initiated, the 2714 performs the following.

- Tunes to the visual carrier frequency, then counts and records the frequency
- Sets the sweep speed to 100 ms/div and acquisition mode to peak, sweeps once, does a peak search with the marker, and records the maximum value as the visual carrier level
- Sets the sweep speed back to 20 ms/div, tunes to the aural carrier frequency and counts it, takes the difference between the visual carrier frequency and the aural carrier frequency, and records the result as the intercarrier frequency
- Does a peak search with the marker, subtracts the maximum detected value from the visual carrier level, and records the result as the visual-to-aural carrier amplitude ratio
- Performs flatness corrections on both the visual and aural carrier levels

### Enable CARRIER LEVELS Measurement

Press **[CATV/APPL]** to call up the CATV MEASUREMENTS menu. See Figure 6-1.

(As mentioned earlier, the menu resides on two pages, and you can toggle between the pages by pressing **[9]** ).

Press **[1]** to select the CARRIER LEVELS measurement menu. This gives you the following options.

- 0 RUN CARRIER LEVELS
- 1 STORE CURRENT RESULTS
- 2 DISPLAY RESULTS
- 3 PRINT CURRENT RESULTS (*RS-232 Only*)
- 4 PRINT STORED RESULTS (*RS-232 Only*)
- 6 EXTERNAL ATTEN/AMPL

## CATV Measurements

In addition, the software lets you create your own customized table(s) to accommodate all non-standard channel frequencies and operating conditions you may have in your system, enabling you to measure all signals in your unique system.

The following defaults are common to all channels in the factory-loaded channel tables.

Color System	NTSC
Channel Allocation Width	6 MHz
Aural Carrier Offset	4.5 MHz
Channel Edge	(Visual Carrier – 1.25 MHz)
Signal Type	TV
Video Polarity	Negative
Sync Polarity	Positive
Skip Status	False
Scrambling Status	False
VITS	None

Channels 907 through 913 in the STD factory-loaded channel table (Table 6-3) represent channels T–7 through T–13.

### Selecting a Channel Table

Press [CATV/APPL] [8] [1] to call up the channel table menu. Press a number corresponding to the desired channel table to select a table. Press any menu button to return to the spectral display.

### Selecting a Text Channel

While in the spectral display, enter the desired test channel by pressing keypad numbers corresponding to the desired channel and terminate the entry by pressing [W], or enter any frequency within the channel band of the desired channel and terminate with [X], [Y], or [Z]. Refer to Tables 6-3 through 6-5 for factory-loaded channel tables.

#### NOTE

*You can define your own custom channel tables and download them to the 2714 using the PC software provided with the instrument.*

Table 6-5 IRC (Cont.)

Channel	Visual Carrier	Aural Carrier
71	505.25	509.75
72	511.25	515.75
73	517.25	521.75
74	523.25	527.75
75	529.25	533.75
76	535.25	539.75
77	541.25	545.75
78	547.25	551.75
79	553.25	557.75
80	559.25	563.75
81	565.25	569.75
82	571.25	575.75
83	577.25	581.75
84	583.25	587.75
85	589.25	593.75
86	595.25	599.75
87	601.25	605.75
88	607.25	611.75
89	613.25	617.75
90	619.25	623.75
91	625.25	629.75
92	631.25	635.75
93	637.25	641.75
94	643.25	647.75

Table 6-3: STD

Channel	Visual Carrier	Aural Carrier
907	7.00	11.5
908	13.00	17.5
909	19.00	23.5
910	25.00	29.5
911	31.00	35.5
912	37.00	41.5
913	43.00	47.5
<hr/>		
2	55.25	59.75
3	61.25	65.75
4	67.25	71.75
5	77.25	81.75
6	83.25	87.75
<hr/>		
95	91.25	95.75
96	97.25	101.75
97	103.25	107.75
98	109.25	113.75
99	115.25	119.75
<hr/>		
14	121.25	125.75
15	127.25	131.75
16	133.25	137.75
17	139.25	143.75
18	145.25	149.75
19	151.25	155.75
20	157.25	161.75
21	163.25	167.75
22	169.25	173.75
<hr/>		
7	175.25	179.75
8	181.25	185.75
9	187.25	191.75
10	193.25	197.75
11	199.25	203.75
12	205.25	209.75
13	211.25	215.75

Table 6-3 STD (Cont.)

Channel	Visual Carrier	Aural Carrier
23	217.25	221.75
24	223.25	227.75
25	229.25	233.75
26	235.25	239.75
27	241.25	245.75
28	247.25	251.75
29	253.25	257.75
<hr/>		
30	259.25	263.75
31	265.25	269.75
32	271.25	275.75
33	277.25	281.75
34	283.25	287.75
35	289.25	293.75
36	295.25	299.75
<hr/>		
37	301.25	305.75
38	307.25	311.75
39	313.25	317.75
40	319.25	323.75
41	325.25	329.75
42	331.25	335.75
43	337.25	341.75
<hr/>		
44	343.25	347.75
45	349.25	353.75
46	355.25	359.75
47	361.25	365.75
48	367.25	371.75
49	373.25	377.75
50	379.25	383.75
<hr/>		
51	385.25	389.75
52	391.25	395.75
53	397.25	401.75
54	403.25	407.75
55	409.25	413.75
56	415.25	419.75
57	421.25	425.75

**CATV Measurements**

**Table 6-5: IRC**

Channel	Visual Carrier	Aural Carrier
2	55.25	59.75
3	61.25	65.75
4	67.25	71.75
1	73.25	77.75
5	79.25	83.75
6	85.25	89.75
95	91.25	95.75
96	97.25	101.75
97	103.25	107.75
98	109.25	113.75
99	115.25	119.75
14	121.25	125.75
15	127.25	131.75
16	133.25	137.75
17	139.25	143.75
18	145.25	149.75
19	151.25	155.75
20	157.25	161.75
21	163.25	167.75
22	169.25	173.75
7	175.25	179.75
8	181.25	185.75
9	187.25	191.75
10	193.25	197.75
11	199.25	203.75
12	205.25	209.75
13	211.25	215.75
23	217.25	221.75
24	223.25	227.75
25	229.25	233.75
26	235.25	239.75
27	241.25	245.75
28	247.25	251.75
29	253.25	257.75
30	259.25	263.75
31	265.25	269.75
32	271.25	275.75
33	277.25	281.75
34	283.25	287.75

**Table 6-5 IRC (Cont.)**

Channel	Visual Carrier	Aural Carrier
35	289.25	293.75
36	295.25	299.75
37	301.25	305.75
38	307.25	311.75
39	313.25	317.75
40	319.25	323.75
41	325.25	329.75
42	331.25	335.75
43	337.25	341.75
44	343.25	347.75
45	349.25	353.75
46	355.25	359.75
47	361.25	365.75
48	367.25	371.75
49	373.25	377.75
50	379.25	383.75
51	385.25	389.75
52	391.25	395.75
53	397.25	401.75
54	403.25	407.75
55	409.25	413.75
56	415.25	419.75
57	421.25	425.75
58	427.25	431.75
59	433.25	437.75
60	439.25	443.75
61	445.25	449.75
62	451.25	455.75
63	457.25	461.75
64	463.25	467.75
65	469.25	473.75
66	475.25	479.75
67	481.25	485.75
68	487.25	491.75
69	493.25	497.75
70	499.25	503.75

**CATV Measurements**

**Table 6-3 STD (Cont.)**

<b>Channel</b>	<b>Visual Carrier</b>	<b>Aural Carrier</b>
58	427.25	431.75
59	433.25	437.75
60	439.25	443.75
61	445.25	449.75
62	451.25	455.75
63	457.25	461.75
64	463.25	467.75
65	469.25	473.75
66	475.25	479.75
67	481.25	485.75
68	487.25	491.75
69	493.25	497.75
70	499.25	503.75
71	505.25	509.75
72	511.25	515.75
73	517.25	521.75
74	523.25	527.75
75	529.25	533.75
76	535.25	539.75
77	541.25	545.75
78	547.25	551.75
79	553.25	557.75
80	559.25	563.75
81	565.25	569.75
82	571.25	575.75
83	577.25	581.75
84	583.25	587.75
85	589.25	593.75
86	595.25	599.75
87	601.25	605.75
88	607.25	611.75
89	613.25	617.75
90	619.25	623.75
91	625.25	629.75
92	631.25	635.75
93	637.25	641.75
94	643.25	647.75

**Table 6-4: HRC**

<b>Channel</b>	<b>Visual Carrier</b>	<b>Aural Carrier</b>
2	54.00	58.5
3	60.00	64.5
4	66.00	70.5
1	72.00	76.5
5	78.00	82.5
6	84.00	88.5
95	90.00	94.50
96	96.00	100.50
97	102.00	106.50
98	108.00	112.50
99	114.00	118.50
14	120.00	124.50
15	126.00	130.50
16	132.00	136.50
17	138.00	142.50
18	144.00	148.50
19	150.00	154.50
20	156.00	160.50
21	162.00	166.50
22	168.00	172.50
7	174.00	178.50
8	180.00	184.50
9	186.00	190.50
10	192.00	196.50
11	198.00	202.50
12	204.00	208.50
13	210.00	214.50
23	216.00	220.50
24	222.00	226.50
25	228.00	232.50
26	234.00	238.50
27	240.00	244.50
28	246.00	250.50
29	252.00	256.50
30	258.00	262.50
31	264.00	268.50
32	270.00	274.50
33	276.00	280.50
34	282.00	286.50

Table 6-4 HRC (Cont.)

Channel	Visual Carrier	Aural Carrier
35	288.00	292.50
36	294.00	298.50
37	300.00	304.50
38	306.00	310.50
39	312.00	316.50
40	318.00	322.50
41	324.00	328.50
42	330.00	334.50
43	336.00	340.50
44	342.00	346.50
45	348.00	352.50
46	354.00	358.50
47	360.00	364.50
48	366.00	370.50
49	372.00	376.50
50	378.00	382.50
51	384.00	388.50
52	390.00	394.50
53	396.00	400.50
54	402.00	406.50
55	408.00	412.50
56	414.00	418.50
57	420.00	424.50
58	426.00	430.50
59	432.00	436.50
60	438.00	442.50
61	444.00	448.50
62	450.00	454.50
63	456.00	460.50
64	462.00	466.50
65	468.00	472.50
66	474.00	478.50
67	480.00	484.50
68	486.00	490.50
69	492.00	496.50
70	498.00	502.50

Table 6-4 HRC (Cont.)

Channel	Visual Carrier	Aural Carrier
71	504.00	508.50
72	510.00	514.50
73	516.00	520.50
74	522.00	526.50
75	528.00	532.50
76	534.00	538.50
77	540.00	544.50
78	546.00	550.50
79	552.00	556.50
80	558.00	562.50
81	564.00	568.50
82	570.00	574.50
83	576.00	580.50
84	582.00	586.50
85	588.00	592.50
86	594.00	598.50
87	600.00	604.50
88	606.00	610.50
89	612.00	616.50
90	618.00	622.50
91	624.00	628.50
92	630.00	634.50
93	636.00	640.50
94	642.00	646.50



- Input Power Limitations, 6-2
- Listen, 4-27
- MODULATION DEPTH Measurement, 6-18
- Preliminary Information, 6-1
- Typical, 3-13
- View Modulation (Field), 4-26
- View Modulation (Line), 4-26
- View Picture, 4-26
- CAUTION
  - statement in manuals, xv
  - statement on equipment, xv
- Center Measure, 5-34
- Center or Start Frequency Selection, 7-24
- CHAN/FREQ, 4-5
- Change Menu Status, 7-2
- Changing Acquisition Mode, 7-37
- Changing Reference Level Units, 7-6
- Channel Entry, 5-6
  - Arrow Keys, 5-6
  - Keypad Entry, 5-7
- Channel Skip Procedure, 6-16
- Channel Table Files, 7-78
- Channel Table Selection, 3-13, 6-6
- Channel Tables, Custom, 6-6
- Characteristics, 2-1
  - Amplitude Related, 2-16
  - Electrical, 2-1
  - Environmental Characteristics, 2-25
  - Frequency Related, 2-11
  - Frequency/Amplitude Related, 2-14
  - General Characteristics, 2-23
  - Input/Output Signal, 2-20
  - Physical Characteristics, 2-26
  - Power Requirements, 2-22
  - Supplementary Characteristics Due to Options, 2-23
- Chassis and Signal Ground, 8-4
- Communication Port
  - GPIO, 4-16
  - RS-232, 4-17
- Communications Ports, Configuring, 7-69
- Configuring the Communications Port, 7-69
  - GPIO Configuration, 7-71
  - RS-232 Configuration, 7-69
- Connectors, 4-3
- Control Panel
  - Arrow Keys, 3-10
  - Dedicated Controls, 3-10
  - Function Blocks, 3-9
- Control Panel Basics, 3-9
- Controls, 4-3
  - FREQ/MKRS, 4-4
  - MKR Arrow Keys, 4-4
- Counter Resolution, 7-25
- Create an Antenna Table, 7-15
- CROSS MODULATION Measurement, 6-41
  - Enable CROSS MODULATION Measurement, 6-41
- Cross Modulation Selection, 4-28
- CTB/CSO Measurement, 6-32
  - Automatic Mode, 6-33
  - Automatic Mode Procedure, 6-36
  - Automatic With Pause Mode, 6-33
  - Automatic With Pause Mode Procedure, 6-38
  - Enable CTB/CSO Measurement, 6-34
  - Interactive Mode, 6-33
  - Interactive Mode Procedure, 6-34
  - Single-sweep Mode, 6-33
  - Single-sweep Mode Procedure, 6-39
  - Typical CTB/CSO Measurement Results Display, 6-36
- CTB/CSO Selection, 4-27
- CTR-MEAS/TRKG, 5-34
  - Arrow Keys, 5-37
- CTR-MEAS/TRKG, 4-4
- Curve Files, 7-78
- Custom Channel Tables, 6-6

Plotter Language, 4-17  
Plotter Output, Typical, 5-39  
POWER, 4-10  
Power Requirements, 2-22  
Power-down Settings, Recall, 7-64  
Power-up Settings, User-defined, 7-64  
Power, Mains, 3-3, 8-1  
Preamp Control, 4-34  
Preamplifier, Turning ON/OFF, 7-10  
Precautions  
    Handling, 3-3  
    RF INPUT, 3-3  
Print All Normalization Values, 4-19  
Printer Configuration, 4-18, 7-73  
Printing The On-screen Readouts, 7-85  
Programmed Tuning, 7-26  
Programmed Tuning Increment, 4-20  
Protecting Files, 7-79

---

## R

Rackmount Adapter Installation, 3-2  
Range  
    CHAN/FREQ Control, 4-5  
    REF LEVEL Control, 4-5  
    SPAN/DIV Control, 4-5  
READOUT, 4-9, 5-39  
Real-Time Clock Setup, 4-18  
Recall and Save Settings and Displays, 7-63  
Recall Last Power-down Settings, 7-64  
Receiving, 3-1  
Recenter Channel, 4-22  
REF LEVEL, 4-5  
    Arrow Keys, 4-6  
    STEP, 4-6  
    ZERO and MAX Keys, 4-6  
Ref Level Unit Selection, 4-34  
REF LVL STEP, 4-6, 5-13

Reference Level Operation  
    Arrow Keys, 5-11  
    Keypad Entry, 5-12  
    REF LVL STEP, 5-13  
Reference Level Settings, Keypad, 4-15  
Reference Level Units, Changing, 7-6  
Reference Normalizations, 4-19  
Register Priority, 5-28  
Register Select and Save Keys, 4-8  
Registers, A, B, C, 5-26  
RES BW, 5-15  
    Arrow Keys, 5-16  
    AUTO, 5-17  
Resolution Bandwidth Settings, 4-16  
RF Attenuation Selection, 4-35  
RF Attenuation Settings, Keypad, 4-15  
RF Attenuation, Setting, 7-5  
RF INPUT, 3-3  
RS-232  
    BAUD RATE, 4-17, 7-70  
    Configuration, 7-69  
    DATA BITS, 4-17, 7-70  
    ECHO, 4-17, 7-71  
    EOL, 4-17, 7-70  
    FLOW CONTROL, 4-17, 7-70  
    PARITY, 4-17, 7-70  
    Printing The On-screen Readouts, 7-85  
    STATUS, 4-17, 7-69  
    VERBOSE, 4-17, 7-71  
Running the Automatic Measurement, 6-46  
Running the Interactive Measurement, 6-45

---

## S

Safe Maximum Signal Levels, 6-2  
Safety, Symbols, xv

---

## D

- D Register, 5-29
- DANGER, statement on equipment, xv
- Date and Time, Setting, 7-77
- DBUV/M
  - Antenna Factors, 7-17
  - Create an Antenna Table, 7-15
  - Equipment Setup for Field Strength Measurements, 7-13
  - Equivalent Decibel – Voltage Values, 7-15
  - Procedure, 7-14
  - Using, 7-11
- Dedicated Controls, 3-10
- DEMODO Menu, 7-58
  - Listening to AM or FM Transmissions, 7-59
  - Listening to AM Transmissions, 7-59
  - Listening to FM Transmissions, 7-58
  - Video Demodulation, 7-60
- Demodulator (DEMODO) Menu, 4-30
  - AM Demodulator, 4-30
  - Broadcast (AM) Video, 4-30
  - FM Demodulator, 4-30
  - Video Monitor Setup, 4-30
- Diagnostics/Adjustments, Instrument, 4-19
- Digital Communications Port, 8-7
- Digital/Analog Mode Selection, 4-32
- Dimensions, 2-26
- Display (DSPL) Menu, 4-32
  - Acquisition Mode, 4-33
  - B,C Minus A, 4-33
  - B,C Minus A Offset To, 4-33
  - Digital/Analog Modes, 4-32
  - Display Line, 4-33
  - Display Source (AM), 4-33
  - Ensemble Averaging, 4-32
  - Graticule Illumination, 4-33
  - Min Hold In WFM nn, 4-34
  - Display Line and Limit Detector, 7-42
  - Display Line Control, 4-33
  - Display Message, 4-31
  - Display Registers, 5-25
    - Analog Display, 5-26
    - D Register, 5-29
    - MAX HOLD A & B, 5-31
    - Register Priority, 5-28
  - Display Screen, 4-1
  - Display Source (AM), 4-33
  - Display Storage, 5-25
    - Display Registers, 5-25
    - SAVE ENABLE, 5-26
  - Display, Aligning, 7-81
  - Display, Initial, 3-7
  - Displaying an External Source, 7-41
  - Displays and Settings, Save and Recall, 7-63
- Dot Key, 4-7
- DSPL Menu, 7-28
  - Activating Minimum Hold, 7-44
  - Adding Titles and Labels, 7-38
  - B,C MINUS A, 7-33
  - Changing Acquisition Mode, 7-37
  - Changing the Display Mode, 7-29
  - Displaying an External Source, 7-41
  - Ensemble Averaging, 7-30
  - Subtracting Stored Signals, 7-33
  - The Display Line and Limit Detector, 7-42
  - Turning Graticule Illumination On and OFF, 7-41

---

## E

- Edit a Title, 7-39
- Electrical Characteristics, 2-1
  - CATV, 2-1
- Ensemble Averaging, 4-32, 7-30
  - Max, 4-33

INPUT, 7-4  
MKR/FREQ, 7-19  
SWP/TRIG, 4-14  
UTIL, 4-15, 7-61  
Min Averaging, 4-33  
Min Hold In WFM nn, 4-34  
Minimum Hold, Activating, 7-44  
Minimum Signal Size, 4-18  
Minimum Signal Size, Setting, 7-74  
MKR/Delta/OFF, 4-4  
MKR/FREQ Menu, 7-19  
    Center or Start Frequency, 7-24  
    Changing the Knob Function,  
        7-21  
    Counter Resolution, 7-25  
    Frequency Offsets, 7-27  
    Marker to the Reference Level,  
        7-23  
    Moving the Marker to the Next  
        Higher or Lower Peak, 7-22  
    Programmed Tuning, 7-26  
    Selecting the Tuning Increment,  
        7-23  
    Setting Start and Stop Frequen-  
        cies, 7-19  
    Setting the Signal Threshold, 7-25  
    Transposing Markers, 7-20  
    Using Markers to Set Start and  
        Stop Frequencies, 7-20  
Mode 1 Frequency Response Mea-  
    surement Test, 6-27  
    Running The Mode 1 Text, 6-28  
Mode 2 Frequency Response Mea-  
    surement Test, 6-27  
    Running The Mode 2 Test, 6-28  
Modulation Depth, 4-23  
MODULATION DEPTH Measure-  
    ment, 6-18  
    Enable MODULATION DEPTH  
        Measurement, 6-19  
Move Marker To Next Peak, 4-20

---

## N

Noise Normalized Selection, 4-29  
Noise-averaging Filter, 5-18  
Normal Mode, Frequency Entry, 5-8  
Normalization Debug To Printer, 4-19  
Normalization File, 7-78  
Normalization Values, 4-19  
Normalization, Initial, 3-6  
Normalizations, 4-16  
Normalizing the 2714, 7-66  
Number Of Averages, 4-33  
Numeric Keys, 4-7  
NVRAM, If You Lose, 7-83

---

## O

OBW. *See Occupied Bandwidths  
(OBW), Measuring*  
Occupied Bandwidth Selection, 4-29  
Occupied Bandwidths (OBW),  
    Measuring, 7-52  
Offsets, Frequency, 7-27  
Options, Confirming Installed, 7-80  
Oscilloscope Trigger Modes, 7-86

---

## P

Packaging, 3-1  
Parameter Value, Enter, 7-3  
Pause For "User Def" Key, 4-31  
PEAK FIND, 4-4, 5-37  
Phaselock Selection, 4-18  
Phaselock, Turning On and Off, 7-75  
Physical Characteristics, 2-26  
PLOT, 4-9, 5-38  
Plot Position, 4-18  
Plotter Configuration. *See Selecting  
the Screen Plotter Configuration*

- Max/Min, 4-33
- Mean, 4-33
- MIN, 4-33
- Number Of Averages, 4-33
- Save Results In Display, 4-33
- Enter Parameter Value, 7-3
- Environmental Characteristics, 2-25
- Exit From a Menu, 7-4
- External Amplification/Attenuation, 7-7
- External Atten/Amp Selection, 4-35
- External Input and Output
  - J101 – TV Sideband Analyzer Interface, 8-1
  - J102 – External Trigger, 8-2
  - J103 – Accessory Connector, 8-3
  - J104 – Digital Communications Port, 8-7
- Mains Power, 8-1
- External Source, Displaying, 7-41
- External Trigger Selection, 4-14
- External Trigger, J102, 8-2
- External Video Input, 8-3

---

## F

- Factory Default Settings, 3-5, 3-7
  - Restoring, 3-7
- FAST SURVEY OFF, 6-15
- FAST SURVEY ON, 6-15
- Field Triggering, TV Video, 7-91
- File System, 7-77
  - Antenna Table Files, 7-78
  - CATV Measurement Results Files, 7-78
  - Channel Table Files, 7-78
  - Curve Files, 7-78
  - Flatness Correction Data Files, 7-78
  - Normalization File, 7-78
  - Settings Files, 7-78

- User-Defined Program (UDP) Files, 7-78
- Files, Protection, 7-79
- First Mixer Input Level, Setting, 7-9
- Flatness Correction Data Files, 7-78
- FM Demodulator, 4-30
- FM Deviation. *See Frequency Deviation, Viewing*
- FM DEVIATION Measurement. *See AURAL (FM) DEVIATION Measurement*
- FM Transmissions, Listening to, 7-58
- FM VOL, 4-10
- Free Run Trigger Selection, 4-14
- FREQ/MKRS, 4-4, 5-8, 5-32
  - MKR/ $\Delta$ /OFF, 5-32
- Frequency Corrections On and Off, 7-75
- Frequency Corrections Selection, 4-18
- Frequency Deviations, Viewing, 7-56
- Frequency Entry (Non-CATV Mode), 5-10
  - Arrow Keys, 5-10
  - Keypad Entry, 5-10
- Frequency Entry (Normal Mode), 5-8
  - Arrow Keys, 5-8
  - FREQ/MKRS, 5-8
  - Keypad Entry, 5-9
- Frequency Knob Function, 4-20
- Frequency Measurement Process, 3-15
- Frequency Normalizations, 4-19
- Frequency Offsets, 7-27
- Frequency Related Characteristics, 2-11
- FREQUENCY RESPONSE Measurement, 6-27
  - Acquire a Frequency Response Reference, 6-31
  - Enable FREQUENCY RESPONSE Measurement, 6-29
  - Mode 1, 6-27
  - Mode 2, 6-27

---

## L

Labels and Titles, Adding, 7-38  
LEVEL, 4-10  
LEVEL Control, 5-24  
Limit Detector and Display Line, 7-42  
LIN, 4-9  
LIN Vertical Scale, 5-20  
Line Modulation Operation, 6-48  
Line Trigger Selection, 4-14  
Line Trigger, TV, 7-88  
Listen, 4-27  
Listen Operation, 6-49  
Listening to AM or FM Transmissions, 7-59

---

## M

Mains Power, 3-3, 8-1  
Manual Organization, 1-1  
Manually Scanning, 7-91  
Marker, Start/Stop, 4-20  
Marker Control, 5-32  
Marker Frequency Tuning, 4-20  
Marker Knob Function, 4-20  
Marker Peak Find, 4-4  
Marker Start/Stop, 4-20  
Marker To Reference Level, 4-20  
Marker to the Reference Level, 7-23  
Marker, Moving to the Next Higher or Lower Peak, 7-22  
Marker/Frequency (MKR/FREQ) Menu, 4-20  
    Frequency Start/Stop, 4-21  
    Knob Function, 4-20  
    Marker Start/Stop, 4-20  
    Marker To Reference Level, 4-20  
    Move Marker To Next Peak, 4-20  
    Programmed Tuning Increment, 4-20  
    Threshold, 4-20  
    Transpose Markers, 4-20  
Marker/Frequency (MKR/FRQ) Menu  
    Setup Table, 4-21  
    Tuning Increment, 4-21  
Markers, Transposing, 4-20, 7-20  
Markers to Set Start and Stop Frequencies, 7-20  
Max Averaging, 4-33  
MAX HOLD A & B, 5-31  
MAX HOLD A&B, 4-8  
MAX Key, 4-6  
Max Span, 5-5  
Max/Min Averaging, 4-33  
Maximum Signal Levels, 6-2  
Mean Averaging, 4-33  
Measurement  
    AURAL (FM) DEVIATION, 6-20  
    CARRIER LEVELS, 6-12  
    CARRIER SURVEY, 6-14  
    CARRIER TO NOISE, 6-22  
    CROSS MODULATION, 6-41  
    CTB/CSO, 6-32  
    FREQUENCY RESPONSE, 6-27  
    HUM/LFD, 6-24  
    In-Channel Response, 6-43  
    MODULATION DEPTH, 6-18  
Measurement Process, 3-15  
    Amplitude, 3-15  
    Frequency, 3-15  
    Verifying, 3-15  
Measurement, Typical CATV, 3-13  
Measuring Carrier-to-Noise Ratios, 7-48  
Measuring Occupied Bandwidths (OBW), 7-52  
Measuring Signal Bandwidths, 7-45  
Menu Display Mode, 4-1  
Menu Display Mode Test Screen, 4-2  
Menu Items Are Not Present, 4-3  
Menu Status, Change, 7-2  
Menu-entered Control Settings, 7-62  
Menus, 4-3  
    APPL, 7-45  
    DEMOD Menu, 7-58  
    DSPL, 7-28

Frequency Response Measurement, 4-25  
Frequency Start/Stop, 4-21  
Frequency/Amplitude Related Characteristics, 2-14  
Function Blocks, 3-9  
Fundamental Operations, 5-3  
    Channel Entry, 5-6  
    Frequency Entry (Non-CATV Mode), 5-10  
    Frequency Entry (Normal Mode), 5-8  
REF LEVEL, 5-11  
SPAN/DIV, 5-3

---

## G

General (CATV) 2714 Mode, 6-4  
    Channel Tables, 6-5, 6-6  
    Selecting a Channel Table, 6-6  
    Signal Types, 6-5  
General Characteristics, 2-23  
GPIB  
    Address, 4-16  
    Configuration, 7-71  
    EOI/LF MODE, 7-71  
    EOI/LF Mode, 4-17  
    GPIB ADDRESS, 7-71  
    POWER ON SRQ, 7-71  
    Power On SRQ, 4-16  
    STATUS, 7-71  
    TALK ONLY MODE, 7-72  
    Talk Only Mode, 4-17  
GPIB Configuration, 7-71  
Graticule Illumination, 4-33, 7-41

---

## H

Headphone Jack, 3-11

Heterodyne, 1-3  
Holdoff, Sweep, 7-76  
Horizontal Position Adjustment, 5-40  
HUM/LFD Measurement, 4-24, 6-24  
    Enable HUM/LFD Measurement, 6-26

---

## I

Immediate Entry Mode, 4-5  
In-Channel Response Measurement, 6-43  
Initial Display, 3-7  
Initial Normalization, 3-6  
Initial Setup, 6-3  
Input (INPUT) Menu, 4-34  
    1st Mixer Input Level Selection, 4-35  
    Cal Signal @100 MHz 18.8 dBmV, 4-35  
    External Atten/Amp Selection, 4-35  
    Preamp, 4-34  
    Ref Level Unit, 4-34  
    RF Attenuation Selection, 4-35  
INPUT Menu, 7-4  
    75/50 Ohm Matching Minimum Loss Pad, 7-9  
    Accommodating a 50 Ohm Source, 7-8  
    Accommodating External Amplification/Attenuation, 7-7  
    Changing Reference Level Units, 7-6  
    Setting the First Mixer Input Level, 7-9  
    Setting the RF Attenuation, 7-5  
    Turning the Calibrator ON and OFF, 7-5  
    Turning the Preamplifier ON/OFF, 7-10  
    Using the DBUV/M, 7-11  
Input Power Limitations, 6-2

Input/Output Signal Characteristics, 2-20  
Installation, Rackmount Adapter, 3-2  
Installed Options Display, 4-19  
Installed Options, Confirming, 7-80  
Instrument Configuration, 7-73  
    AUDIO ALERT, 7-73  
    Audio Alert, 4-18  
    Changing the Sweep Holdoff, 7-76  
    ERROR ONLY, 7-74  
    Frequency Corrections, 4-18  
    Frequency Corrections On and Off, 7-75  
    KEYCLICK & ERROR, 7-74  
    KEYCLICK ONLY, 7-74  
    Minimum Signal Size, 4-18  
    OFF, 7-74  
    Phaselock, 4-18  
    Setting the Minimum Signal Size, 7-74  
    Spectral Display In Menus, 4-18  
    Sweep Holdoff, 4-18  
    The Spectral Display In Menus, 7-76  
    Turning Phaselock On and Off, 7-75  
    Waveform Output Format, 4-18  
    Waveform To Printer, 4-18  
Instrument Diagnostics/Adjustments, 4-19  
    Service Normalizations, 4-19  
INTENSITY, 4-10, 5-40  
Interactive Mode, 6-43  
Internal Trigger Selection, 4-14

---

## J

J101 – TV Sideband Analyzer Interface, 8-1

J102 – External Trigger, 8-2  
J103 – Accessory Connector, 8-3  
    Pin 1 – External Video Input, 8-3  
    Pin 2 – Chassis and Signal Ground, 8-4  
    Pin 3 – Video Output, 8-5  
    Pin 6 – Sweep Gate, 8-5  
    Pin 7 – Sweep Ramp, 8-6  
J104 – Digital Communications Port, 8-7

---

## K

Keypad Entered Increment Tuning, 4-20  
Keypad Entered Settings  
    Frequency, 4-15  
    Reference Level, 4-15  
    Resolution Bandwidth, 4-16  
    RF Attenuation, 4-15  
    Span/Div, 4-15  
    Sweep Rate, 4-16  
    Vertical Scale, 4-16  
    Video Filter, 4-16  
Keypad Entry  
    Channel Entry, 5-7  
    Frequency Entry (Non-CATV Mode), 5-10  
    Frequency Entry (Normal Mode), 5-9  
    Reference Level Operation, 5-12  
    SPAN/DIV, 5-4  
Keys  
    Backspace, 4-7  
    Dot, 4-7  
    Numeric, 4-7  
    Register Select and Save, 4-8  
    SAVE ENABLE, 4-8  
    Terminator, 4-7



- Save and Recall Settings and Displays, 7-63
- SAVE ENABLE, 4-8, 5-26
  - A, B, C Registers, 5-26
- Save Keys, 4-8
- Save Results In Display, 4-33
- Scanning, 1-3
- Scanning, Manual, 7-91
- Screen Intensity, 5-40
- Screen Plot
  - Communication Port, 4-17
  - Configuration, 4-17
    - Graticule Lines On Plot, 4-18
    - Plot Position, 4-18
    - Plots Per Page, 4-18
    - Plotter Language, 4-17
  - Plotter Speed, 4-17
- Screen Plotter Configuration
  - Communication Port, 7-72
  - Plotter Language, 7-72
- Screen Readout, 5-39
- Selecting a Channel Table, 3-13
- Selecting the Screen Plotter Configuration, 7-72
  - COMM PORT, 7-72
  - GRATICULE LINES ON PLOT, 7-73
  - PLOT POSITION, 7-73
  - PLOT SPEED, 7-73
  - PLOTTER LANGUAGE, 7-72
  - SCREEN PLOT CONFIGURATION, 7-73
- Selecting the Tuning Increment, 7-23
  - AUTO Tuning Increment, 7-24
- Self Test, 3-11
- Service Normalizations, 4-19, 7-81
  - Amplitude, 4-19
  - Frequency, 4-19
  - If You Lose NVRAM, 7-83
  - Norm Debug To Printer, 4-19
  - Normalization Values, 4-19
  - Print All Norm Values, 4-19
  - Reference, 4-19
- Service Request, Generating, 7-84
- Set the Reference, 3-18
- Setting Start and Stop Frequencies, 7-19
- Setting the RF Attenuation, 7-5
- Setting the Signal Threshold, 7-25
- Settings and Displays, Save and Recall, 7-63
- Settings Files, 7-78
- Settings, Factory—default, 3-5
- Sideband Analyzer, 1405, 8-1
- Signal Bandwidths, Measuring, 7-45
- Signal Search, 7-50
- Signal Search Menu, 4-29
- Signal Threshold, Setting, 7-25
- Signal Track, 5-36
- Signal Track Mode, 4-4
- Signal Type Measurements, 6-5
- Signal Types, 6-5
- SINGLE, 4-11
- Single Sweep, 4-11, 5-23
- Skip Channels Procedure, 6-16
- Sounds, 3-11
- SPAN/DIV, 4-5
- Span/Div Operation, 5-3
  - Arrow Keys, 5-4
  - Keypad Entry, 5-4
  - Max Span, 5-5
  - Zero Span, 5-6
- Span/Div Settings, 4-15
- Spectral Display In Menus, 4-18, 7-76
- Spectral Display Mode, 4-1
- Spectral Display Mode Test Screen, 4-2
- Start and Stop Frequencies, Setting, 7-19
- Start and Stop Frequencies, Setting with Markers, 7-20
- Starting the Measurement, 6-44
- Stored Settings Protect, 4-18
- Stored Settings, Protecting, 7-77
- Stored Settings/Displays, 4-15
- Stored Signals, Subtracting, 7-33
- Storing, 3-1



- Supplementary Characteristics Due to Options, 2-23
  - SWEEP, 5-21
    - Arrow Keys, 5-21
    - AUTO, 5-23
    - SINGLE SWEEP, 5-23
  - Sweep Gate, 8-5
  - Sweep Generator, Free Running, 7-86
  - Sweep Holdoff Selection, 4-18
  - Sweep Holdoff, Changing, 7-76
  - Sweep Menu
    - Manual Scan, 4-14
    - Setup Table, 4-14
    - Sweep Rate, 4-14
    - Sync Polarity, 4-14
  - Sweep Ramp, 8-6
  - Sweep Rate Control, 4-14
  - Sweep Rate Settings, 4-16
  - Sweep Rate, Setting, 7-91
  - Sweep Setup Table, 4-14
  - Sweep/Trigger (SWP/TRG) Menu, 4-14
    - Sweep Menu, 4-14
    - Trigger Menu, 4-14
  - SWP/TRIG Menu, 7-85
    - Free Running the Sweep Generator, 7-86
    - Manually Scanning, 7-91
    - Oscilloscope Trigger Modes, 7-86
    - Setting the Sweep Rate, 7-91
    - TV Line Trigger, 7-88
    - TV Video Field Triggering, 7-91
  - Sync Polarity Control, 4-14
  - System Checkout
    - Factory-default Settings, 3-4
    - Initial Normalization, 3-6
    - Turning On the Spectrum Analyzer, 3-4
    - User-defined Power-up Settings, 3-4
    - Warmup Time, 3-4
  - System Configuration, 7-68
    - Communication Port, 4-16
    - Configuring the Communications Port, 7-69
    - Confirming Installed Options, 7-80
    - GPIB, 4-16
    - Installed Options Display, 4-19
    - Instrument Configuration, 4-18
    - Printer Configuration, 4-18
    - Protecting Files, 7-79
    - Protecting Stored Settings, 7-77
    - Real-Time Clock Setup, 4-18
    - Screen Plot, 4-17
    - Selecting the Screen Plotter Configuration, 7-72
    - Setting the Date and Time, 7-77
    - Stored Settings Protect, 4-18
    - The File System, 7-77
- 
- T**
- Terminator Keys, 4-7
  - Text, 4-1
  - Text Channel Selection, 6-6
  - Text Screen In the Menu Display Mode, 4-2
  - Text Screen In the Spectral Display Mode, 4-2
  - The Menus
    - SWP/TRIG, 7-85
    - USER DEF, 7-92
    - Using the Menus, 7-1
  - Threshold, 4-20
  - Time and Date, Setting, 7-77
  - Title Edit, 4-31
  - Title Mode Display, 4-33
  - Titles and Labels, Adding, 7-38
  - Total Input Power Limitations, 6-2
  - Trace Adjustments, 5-40
  - Trace Rotation Adjustment, 5-40
  - Transposing Markers, 4-20, 7-20
  - Trigger Menu
    - External, 4-14
    - Free Run, 4-14

## **MANUAL CHANGE INFORMATION**

At Tektronix, we continually strive to keep up with the latest electronic developments by adding circuit and component improvements to our instruments as soon as they are developed and tested.

Sometimes, due to printing and shipping requirements, we can't get these changes immediately into printed manuals. Hence, your manual may contain new change information on the following pages.

A single change may affect several sections. Since the change information sheets are carried in the manual until all changes are permanently entered, some duplication may occur. If no such change pages appear following this page, your manual is correct as printed.

- Internal, 4-14
- Line, 4-14
- TV Field, 4-14
- TV Line, 4-14
- Trigger Modes, Oscilloscope, 7-86
- Tuning Increment, 4-21
- Tuning Increment, Selecting, 7-23
- Tuning, Programmed, 7-26
- Turning On the Spectrum Analyzer, 3-5
- Turning the Calibrator On and Off, 7-5
- TV Field Trigger Selection, 4-14
- TV Line Trigger, 7-88
- TV Line Trigger Selection, 4-14
- TV Sideband Analyzer Interface, J101, 8-1
- TV Video Field Triggering, 7-91

---

## U

- Unpacking, 3-1
- USER DEF Menu, 7-92
- User Definable (USER DEF) Menu, 4-31
- User Definable Program Utilities
  - Acquire Key Strokes, 4-31
  - Continuous Execution, 4-31
  - Display Message, 4-31
  - Exit Acquire Mode, 4-31
  - Pause For "User DEF" Key, 4-31
  - Title Edit, 4-31
  - Wait For End Of Sweep, 4-31
- User-defined Power-up Settings, 7-64
- User-defined Routine, Create, 7-93
- User-defined Settings, 7-65
- User-defined Program (UDP) Files, 7-78

- Using Markers to Set Start and Stop Frequencies, 7-20
- Using The Menus, 7-1
  - Change Status, 7-2
  - Enter Parameter Value, 7-3
  - Exit From a Menu, 7-4
- UTIL Menu, 7-61
  - Adjustments, Diagnostics and, 7-81
  - Diagnostics and Adjustments, 7-81
    - Service Normalizations, 7-81
  - Generating a Service Request, 7-84
- Instrument Configuration
  - Sending Waveforms To a Computer, 7-74
  - Settings the Minimum Signal Size, 7-74
- Instrument Diagnostics/Adjustments, 4-19
- Keypad Entered Settings, 4-15
- Manual Adjustments, Aligning the Display, 7-81
- Menu-entered Control Settings, 7-62
- Normalizing the 2714, 7-66
- Other User-defined Settings, 7-65
- Recall Last Power-down Settings, 7-64
- Save and Recall Settings and Displays, 7-63
- Service Request, 4-19
- Stored Settings/Displays, 4-15
- System Configuration, 4-16, 7-68
  - Configuring the Communications Port, 7-69
  - Instrument Configuration. See *Instrument Configuration*
  - Selecting the Printer Configuration, 7-73
  - Turning Phaselock On and Off, 7-75
- User-defined Power-up Settings, 7-64

Utility (UTIL) Menu, 4-15

---

## V

Ventilation, 3-4

VERT SCALE, 5-20

10/5/1, 5-20

LIN, 5-20

Vertical Position Adjustment, 5-40

Vertical Scale Settings, 4-16

VID FLTR, 4-11

Video Demodulation, 7-60

Video Filter, 5-18

Video Filter Settings, 4-16

Video Line Knob Function, 4-20

Video Monitor Setup, 4-30

Video Output, 8-5

View Modulation (Field) Operation,  
6-47

View Modulation (Field) Selection,  
4-26

View Modulation (Line) Selections,  
4-26

View Picture, 4-26

View Picture Operation, 6-49

Viewing Instantaneous Frequency  
Deviation, 7-56

---

## W

Wait For End Of Sweep, 4-31

Waiting For User Defined Power up,  
3-5

Warmup Time, 3-5

WARNING, statement in manual, xv

Waterfall Display, 5-30

Waterfall Mode, 5-29

Waveform Output Format, 4-18

Waveform To Printer, 4-18

Weight, 2-26

What Is a Spectrum Analyzer?, 1-3

---

## Z

ZERO Key, 4-6

Zero Span, 5-6